

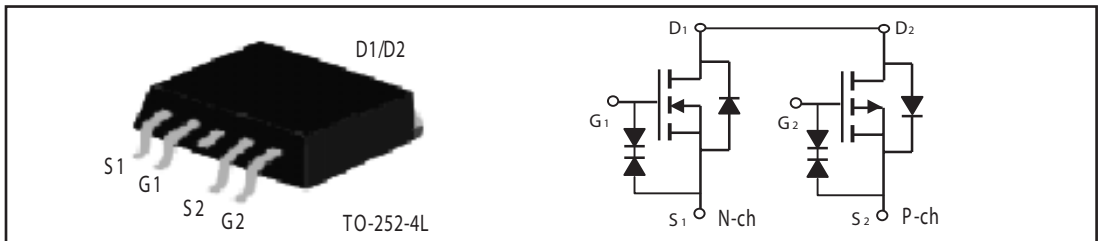

Dual Enhancement Mode Field Effect Transistor (N and P Channel)

PRODUCT SUMMARY (N-Channel)		
V _{DSS}	I _D	R _{DS(ON)} (m Ω) Max
40V	16A	30 @ V _{GS} = 10V
		40 @ V _{GS} = 4.5V

PRODUCT SUMMARY (P-Channel)		
V _{DSS}	I _D	R _{DS(ON)} (m Ω) Max
-40V	-12A	48 @ V _{GS} = -10V
		65 @ V _{GS} = -4.5V



ABSOLUTE MAXIMUM RATINGS (T_A=25°C unless otherwise noted)

Parameter		Symbol	N-Channel	P-Channel	Unit
Drain-Source Voltage		V _{DS}	40	-40	V
Gate-Source Voltage		V _{GS}	±20	±20	V
Drain Current-Continuous @ T _c	25°C	I _D	16	-12	A
	70°C		13.8	-10	A
-Pulsed ^a		I _{DM}	50	-50	A
Drain-Source Diode Forward Current		I _S	8	-6	A
Maximum Power Dissipation	T _c = 25°C	P _D	11		W
	T _c = 70°C		7.7		
Operating Junction and Storage Temperature Range		T _J , T _{STG}	-55 to 175		°C

THERMAL CHARACTERISTICS

Thermal Resistance, Junction-to-Case	R _{θJC}	13.6	°C/W
Thermal Resistance, Junction-to-Ambient	R _{θJA}	120	°C/W

STU407D

N-Channel ELECTRICAL CHARACTERISTICS ($T_A = 25\text{ }^{\circ}\text{C}$ unless otherwise noted)

Parameter	Symbol	Condition	Min	Typ ^c	Max	Unit
OFF CHARACTERISTICS						
Drain-Source Breakdown Voltage	BV_{DSS}	$V_{GS}=0V, I_D=250\mu A$	40			V
Zero Gate Voltage Drain Current	I_{DSS}	$V_{DS}=32V, V_{GS}=0V$			1	μA
Gate-Body Leakage	I_{GSS}	$V_{GS}=\pm 20V, V_{DS}=0V$			± 10	μA
ON CHARACTERISTICS^a						
Gate Threshold Voltage	$V_{GS(th)}$	$V_{DS}=V_{GS}, I_D=250\mu A$	1	1.8	3	V
Drain-Source On-State Resistance	$R_{DS(ON)}$	$V_{GS}=10V, I_D=8A$		22	30	m ohm
		$V_{GS}=4.5V, I_D=6A$		30	40	m ohm
On-State Drain Current	$I_{D(ON)}$	$V_{DS}=5V, V_{GS}=4.5V$	20			A
Forward Transconductance	g_{FS}	$V_{DS}=10V, I_D=8A$		15		S
DYNAMIC CHARACTERISTICS^b						
Input Capacitance	C_{ISS}	$V_{DS}=20V, V_{GS}=0V$ $f=1.0MHz$		735		pF
Output Capacitance	C_{OSS}			120		pF
Reverse Transfer Capacitance	C_{RSS}			70		pF
Gate resistance	R_g	$V_{GS}=0V, V_{DS}=0V, f=1.0MHz$		0.36		ohm
SWITCHING CHARACTERISTICS^b						
Turn-On Delay Time	$t_{D(ON)}$	$V_{DD}=20V$ $I_D=3A$ $V_{GS}=10V$ $R_{GEN}=3\text{ ohm}$		13		ns
Rise Time	t_r			15		ns
Turn-Off Delay Time	$t_{D(OFF)}$			26		ns
Fall Time	t_f			10		ns
Total Gate Charge	Q_g	$V_{DS}=20V, I_D=8A, V_{GS}=10V$		15		nC
		$V_{DS}=20V, I_D=8A, V_{GS}=4.5V$		7.2		nC
Gate-Source Charge	Q_{gs}	$V_{DS}=20V, I_D=8A$		2.0		nC
Gate-Drain Charge	Q_{gd}	$V_{GS}=10V$		3.8		nC

STU407D

P-Channel ELECTRICAL CHARACTERISTICS ($T_A = 25\text{ }^{\circ}\text{C}$ unless otherwise noted)

Parameter	Symbol	Condition	Min	Typ ^c	Max	Unit
OFF CHARACTERISTICS						
Drain-Source Breakdown Voltage	BV_{DSS}	$V_{GS}=0V, I_D=-250\mu A$	-40			V
Zero Gate Voltage Drain Current	I_{DSS}	$V_{DS}=-32V, V_{GS}=0V$			-1	μA
Gate-Body Leakage	I_{GSS}	$V_{GS}=\pm 20V, V_{DS}=0V$			± 10	μA
ON CHARACTERISTICS^a						
Gate Threshold Voltage	$V_{GS(th)}$	$V_{DS}=V_{GS}, I_D=-250\mu A$	-1	-1.6	-3	V
Drain-Source On-State Resistance	$R_{DS(ON)}$	$V_{GS}=-10V, I_D=-6A$		40	48	m ohm
		$V_{GS}=-4.5V, I_D=-4A$		50	65	m ohm
On-State Drain Current	$I_{D(ON)}$	$V_{DS}=-5V, V_{GS}=-10V$	-20			A
Forward Transconductance	g_{FS}	$V_{DS}=-10V, I_D=-6A$		9		S
DYNAMIC CHARACTERISTICS^b						
Input Capacitance	C_{ISS}	$V_{DS}=-20V, V_{GS}=0V$ $f=1.0MHz$		920		pF
Output Capacitance	C_{OSS}			135		pF
Reverse Transfer Capacitance	C_{RSS}			75		pF
Gate resistance	R_g	$V_{GS}=0V, V_{DS}=0V, f=1.0MHz$		3.5		ohm
SWITCHING CHARACTERISTICS^b						
Turn-On Delay Time	$t_{D(ON)}$	$V_{DD}=-20V$ $I_D=-3A$ $V_{GS}=-10V$ $R_{GEN}=3\text{ ohm}$		12		ns
Rise Time	t_r			13		ns
Turn-Off Delay Time	$t_{D(OFF)}$			60		ns
Fall Time	t_f			25		ns
Total Gate Charge	Q_g	$V_{DS}=-20V, I_D=-6A, V_{GS}=-10V$		15		nC
		$V_{DS}=-20V, I_D=-6A, V_{GS}=-4.5V$		7.2		nC
Gate-Source Charge	Q_{gs}	$V_{DS}=-20V, I_D=-6A$		2		nC
Gate-Drain Charge	Q_{gd}	$V_{GS}=-10V$		4.0		nC

STU407D

ELECTRICAL CHARACTERISTICS ($T_A=25^{\circ}\text{C}$ unless otherwise noted)

Parameter	Symbol	Condition	Min	Typ ^c	Max	Unit
DRAIN-SOURCE DIODE CHARACTERISTICS^b						
Diode Forward Voltage	V_{SD}	$V_{GS} = 0\text{V}, I_S = 8\text{A}$ $V_{GS} = 0\text{V}, I_S = -6\text{A}$	N-Ch P-Ch	0.94 -0.87	1.2 -1.2	V

Notes

- a. Pulse Test: Pulse Width $\leq 300 \mu\text{s}$, Duty Cycle $\leq 2\%$.
- b. Guaranteed by design, not subject to production testing.

N-Channel

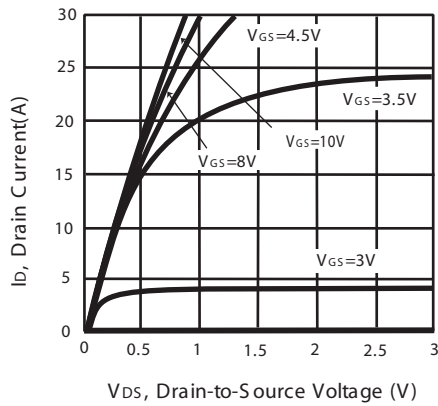

Figure 1. Output Characteristics

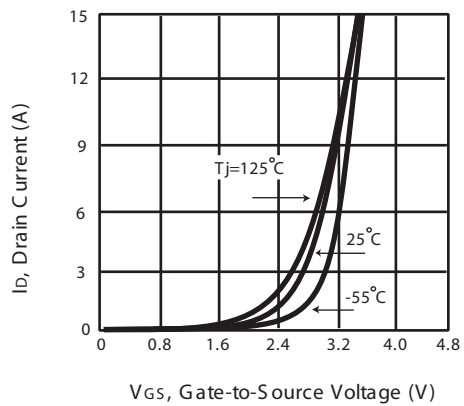

Figure 2. Transfer Characteristics

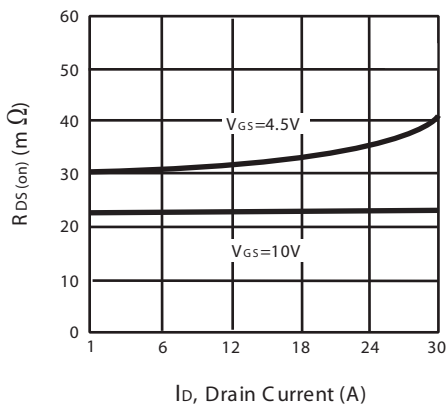

Figure 3. On-Resistance vs. Drain Current and Gate Voltage

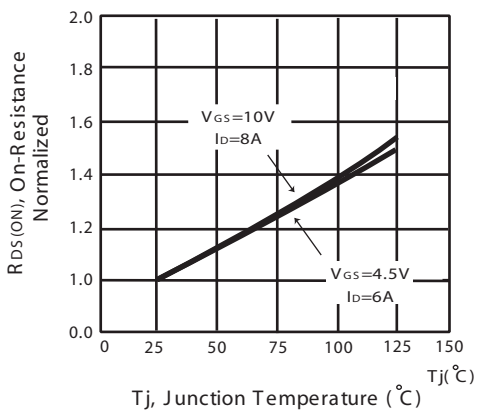

Figure 4. On-Resistance Variation with Drain Current and Temperature

STU407D

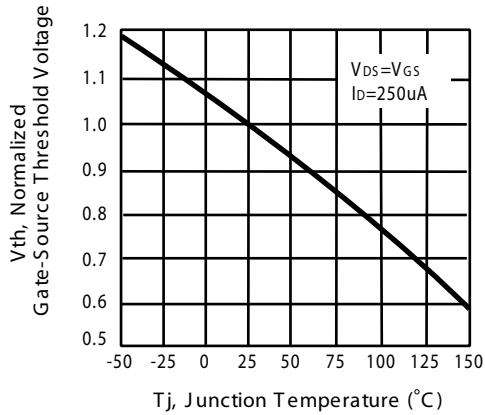

Figure 5. Gate Threshold Variation with Temperature

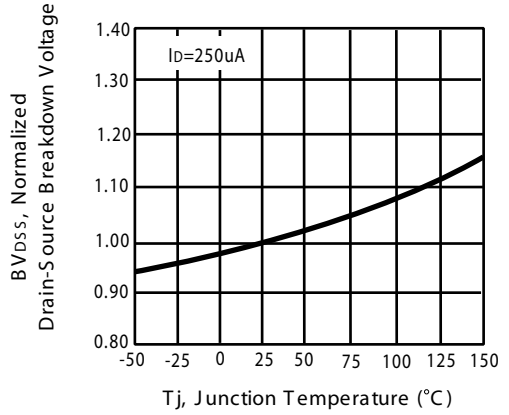

Figure 6. Breakdown Voltage Variation with Temperature

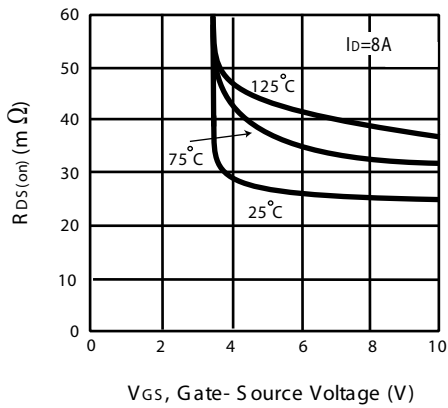

Figure 7. On-Resistance vs. Gate-Source Voltage

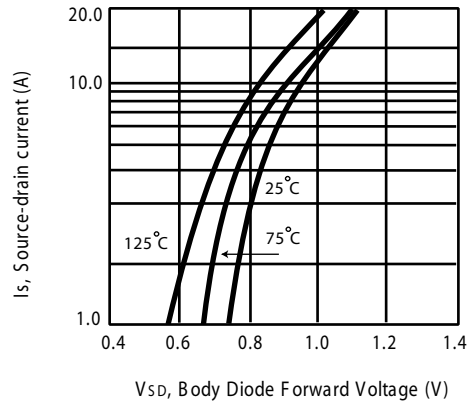

Figure 8. Body Diode Forward Voltage Variation with Source Current

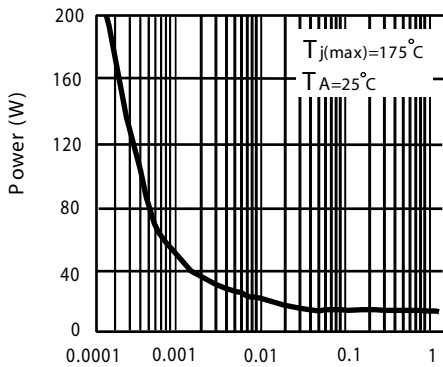
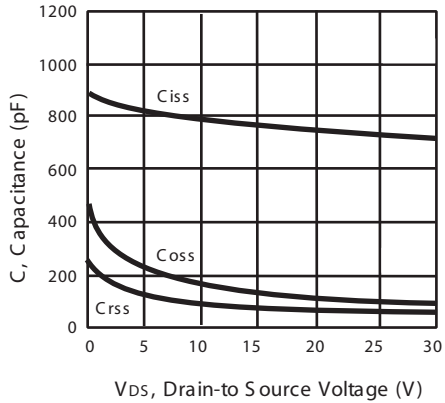

Figure 9. Single Pulse Power Rating Junction-to-Case

STU407D



V_{DS} , Drain-to Source Voltage (V)

Figure 10. Capacitance

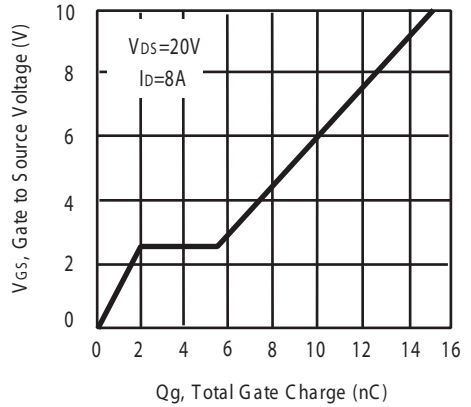

Figure 11. Gate Charge

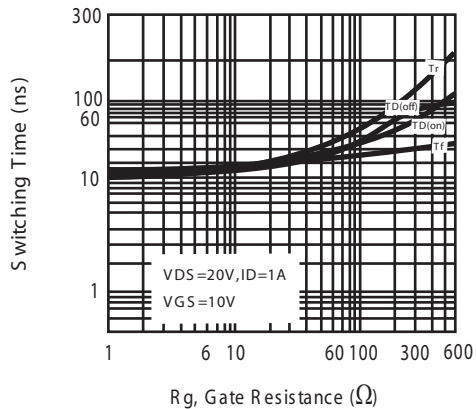

Figure 12. switching characteristics

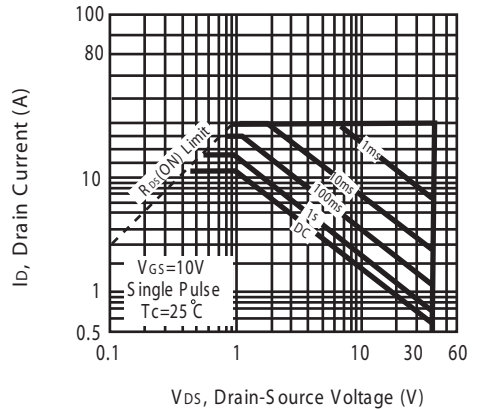

Figure 13. Maximum Safe Operating Area

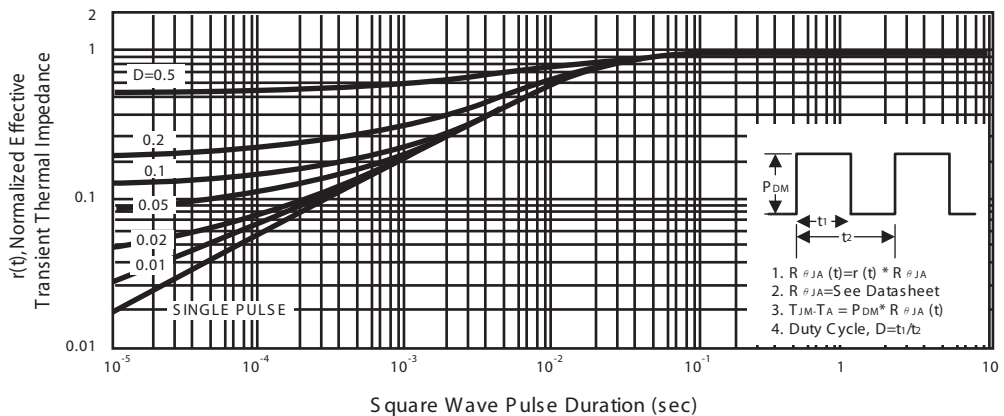

Figure 14. Normalized Thermal Transient Impedance Curve

STU407D

P-Channel

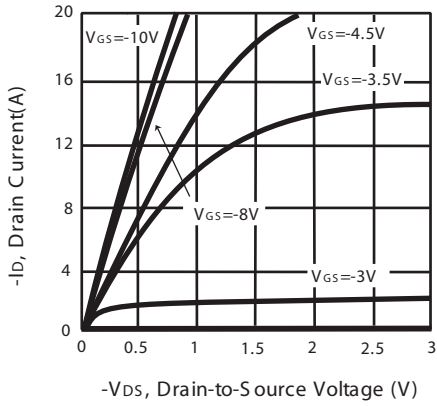

Figure 1. Output Characteristics

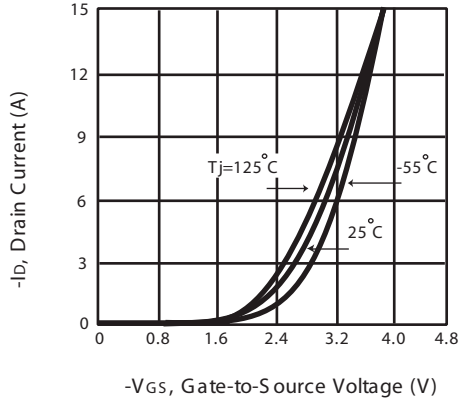

Figure 2. Transfer Characteristics

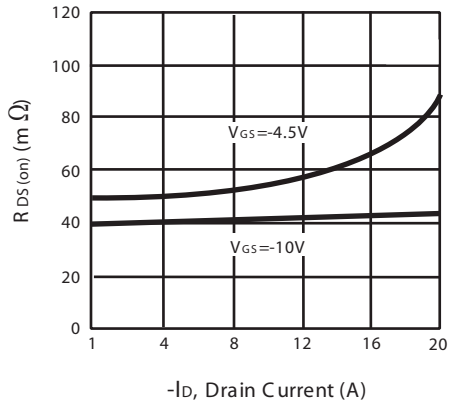

Figure 3. On-Resistance vs. Drain Current and Gate Voltage

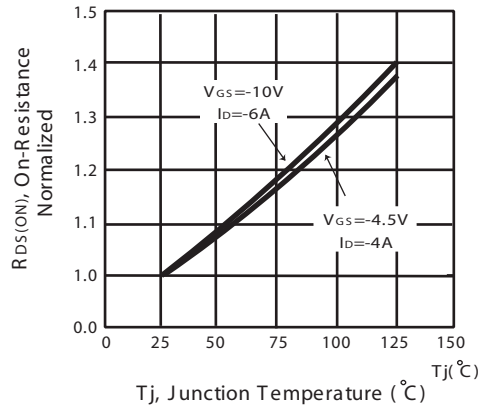

Figure 4. On-Resistance Variation with Drain Current and Temperature

STU407D

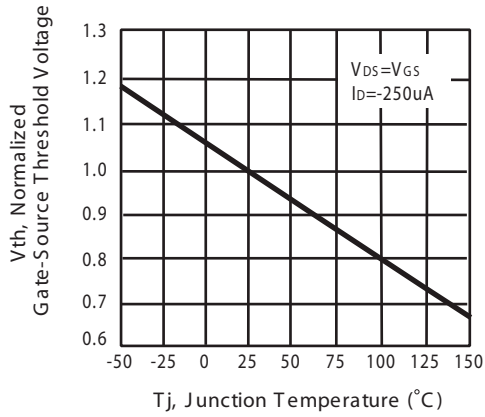

Figure 5. Gate Threshold Variation with Temperature

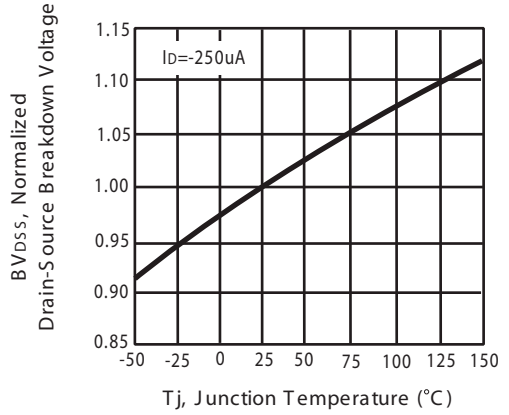

Figure 6. Breakdown Voltage Variation with Temperature

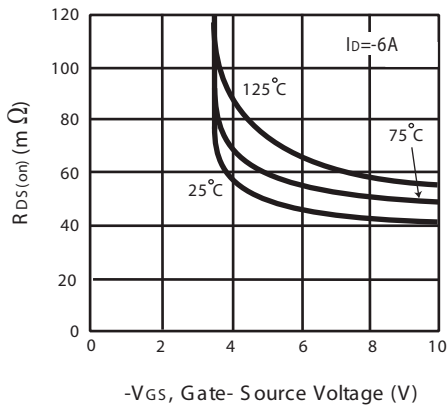

Figure 7. On-Resistance vs. Gate-Source Voltage

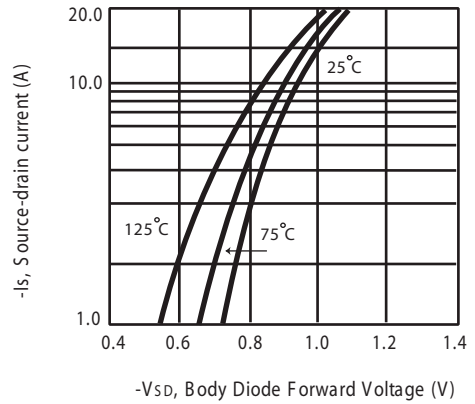

Figure 8. Body Diode Forward Voltage Variation with Source Current

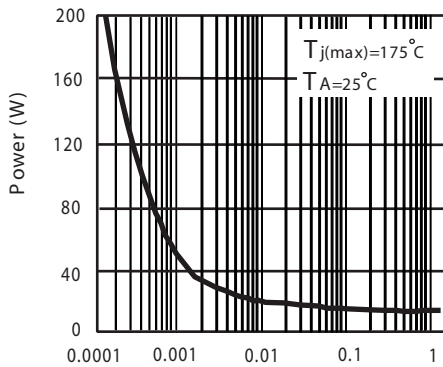

Figure 9. Single Pulse Power Rating Junction-to-Case

STU407D

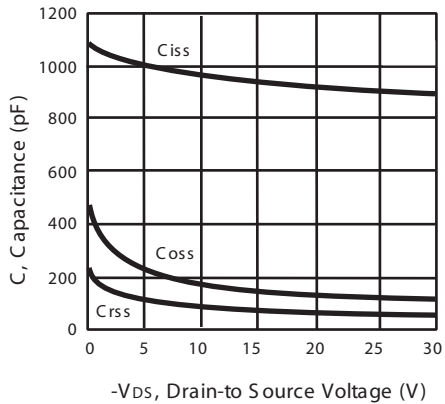

Figure 10. Capacitance

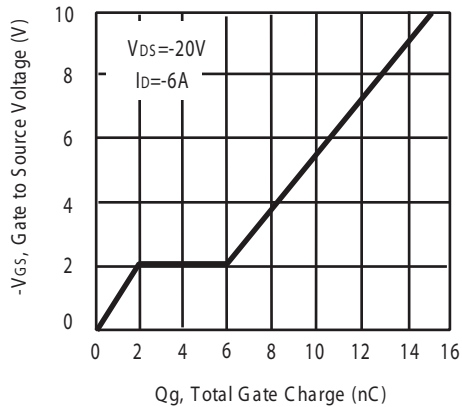

Figure 11. Gate Charge

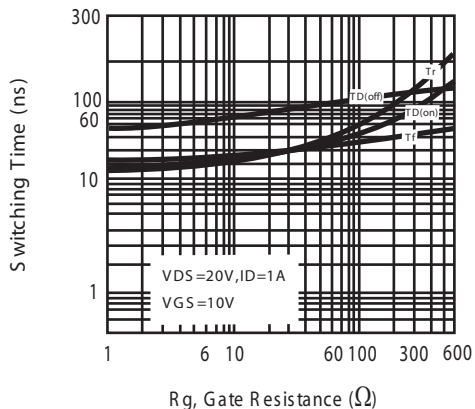

Figure 12. switching characteristics

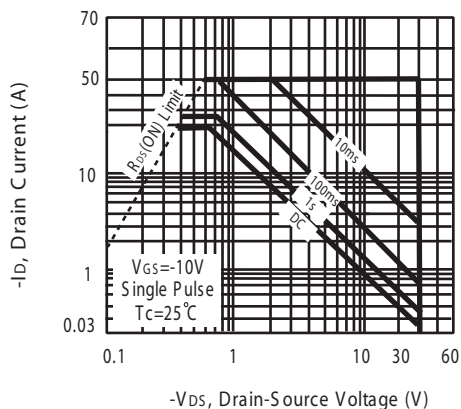

Figure 13. Maximum Safe Operating Area

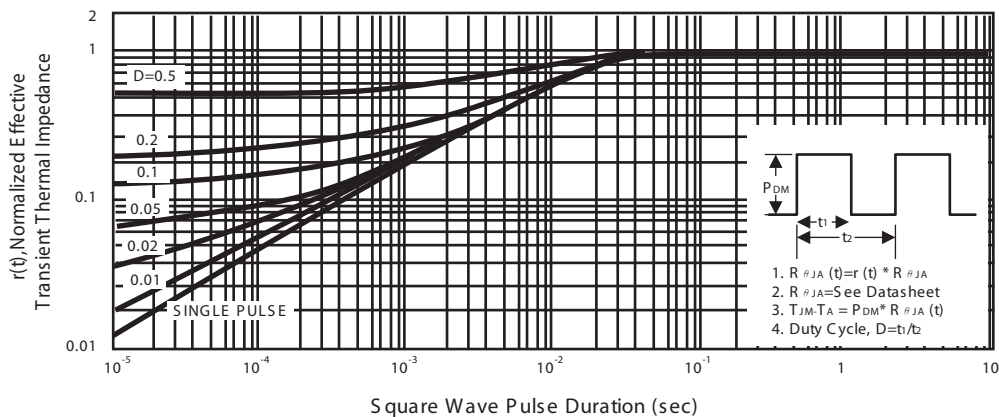
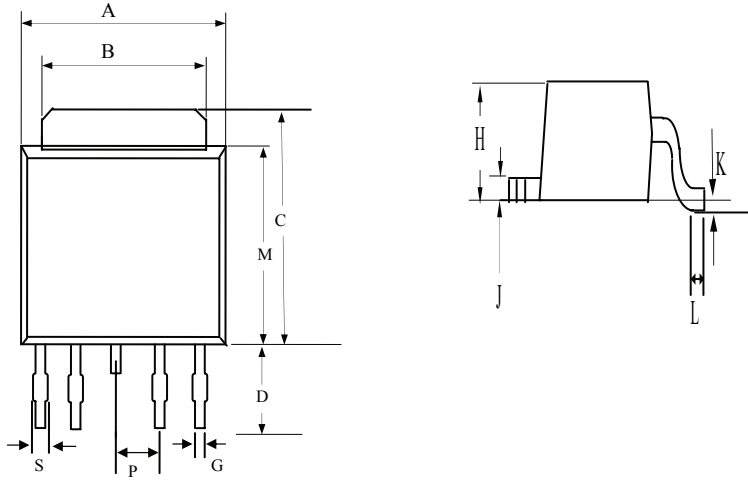

Figure 14. Normalized Thermal Transient Impedance Curve

STU407D

PACKAGE OUTLINE DIMENSIONS

TO-252-4L



REF .	Millimeters	
	MIN	MAX
A	6.40	6.80
B	5.2	5.50
C	6.80	10.20
D	2.20	3.00
P	1.27 REF.	
S	0.50	0.80
G	0.40	0.60
H	2.20	2.40
J	0.45	0.60
K	0	0.15
L	0.90	1.50
M	5.40	5.80

STU407D

TO-252-4L Tape and Reel Data

TO-252-4L Carrier Tape

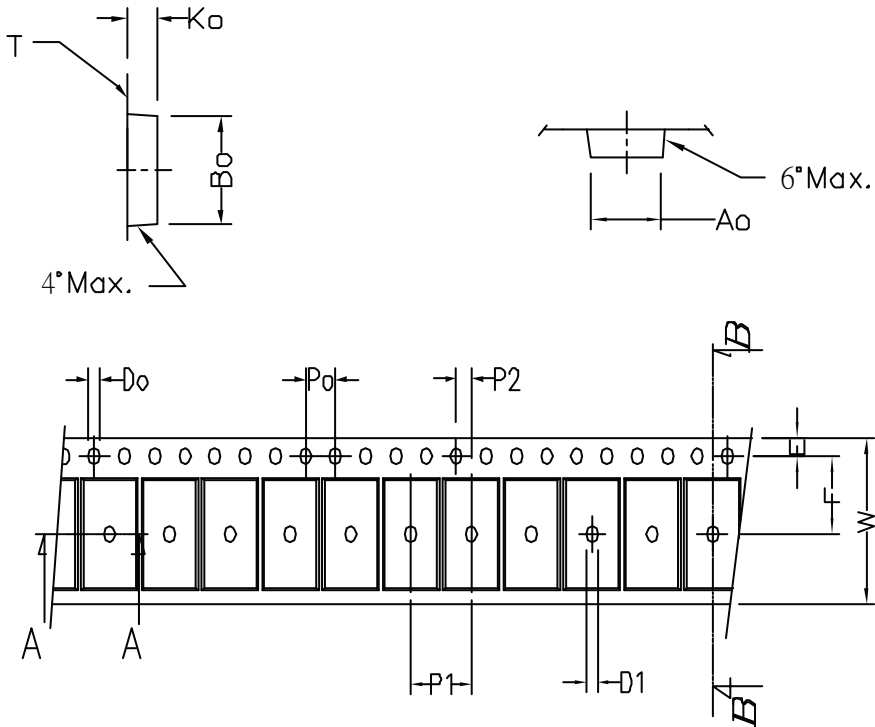

symbol	A_0	B_0	K_0	P_0	P_1	P_2	T
Spec	6.96 ± 0.1	10.49 ± 0.1	2.79 ± 0.1	4.0 ± 0.1	8.0 ± 0.10	2.0 ± 0.05	0.33 ± 0.013
symbol	E	F	D_0	D_1	W	$10P_0$	
Spec	1.75 ± 0.1	7.5 ± 0.05	1.55 ± 0.05	1.5 ± 0.25	$16.0^{+0.3}_{-0.1}$	40.0 ± 0.2	

TO-252-4L Reel

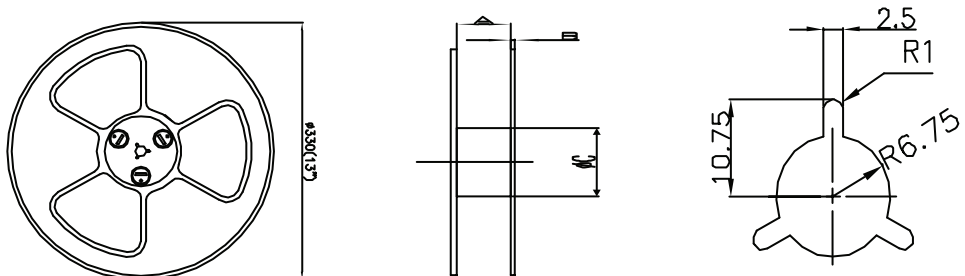

UNIT:mm

Width of carrier tape	8	12	16	24	32	44	56
$A \pm 0.1$	9.4	13.4	17.4	25.4	33.4	45.4	57.4
B	2.3	2.3	2.3	2.3	2.3	2.3	2.3
ϕC	100	100	100	100	100	100	100