

PDP TRENCH IGBT

IRG7S319UPbF

Features

- Advanced Trench IGBT Technology
- Optimized for Sustain and Energy Recovery circuits in PDP applications
- Low $V_{CE(on)}$ and Energy per Pulse (E_{PULSE}^{TM}) for improved panel efficiency
- High repetitive peak current capability
- Lead Free package

Key Parameters		
$V_{CE\ min}$	330	V
$V_{CE(ON)}\ typ.\ @\ I_C = 20A$	1.26	V
$I_{RP}\ max\ @\ T_C = 25^\circ C$	170	A
$T_J\ max$	150	$^\circ C$

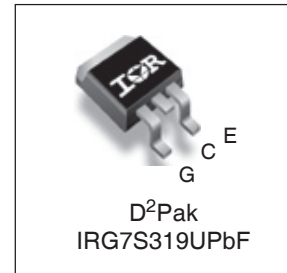
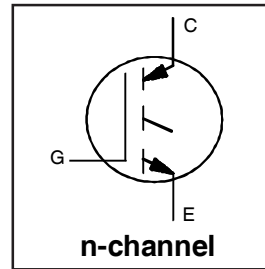

G	C	E
Gate	Collector	Emitter

Description

This IGBT is specifically designed for applications in Plasma Display Panels. This device utilizes advanced trench IGBT technology to achieve low $V_{CE(on)}$ and low E_{PULSE}^{TM} rating per silicon area which improve panel efficiency. Additional features are 150 $^\circ C$ operating junction temperature and high repetitive peak current capability. These features combine to make this IGBT a highly efficient, robust and reliable device for PDP applications.

Absolute Maximum Ratings

	Parameter	Max.	Units
V_{GE}	Gate-to-Emitter Voltage	± 30	V
$I_C @ T_C = 25^\circ C$	Continuous Collector Current, $V_{GE} @ 15V$	45	A
$I_C @ T_C = 100^\circ C$	Continuous Collector, $V_{GE} @ 15V$	20	
$I_{RP} @ T_C = 25^\circ C$	Repetitive Peak Current ①	170	W
$P_D @ T_C = 25^\circ C$	Power Dissipation	96	
$P_D @ T_C = 100^\circ C$	Power Dissipation	38	
	Linear Derating Factor	0.77	$W/^\circ C$
T_J	Operating Junction and	-40 to + 150	$^\circ C$
T_{STG}	Storage Temperature Range		
	Soldering Temperature for 10 seconds	300	

Thermal Resistance

	Parameter	Typ.	Max.	Units
$R_{\theta JC}$	Junction-to-Case ②	—	1.3	$^\circ C/W$

Electrical Characteristics @ $T_J = 25^\circ\text{C}$ (unless otherwise specified)

	Parameter	Min.	Typ.	Max.	Units	Conditions
BV_{CES}	Collector-to-Emitter Breakdown Voltage	330	—	—	V	$V_{GE} = 0V, I_{CE} = 250\mu A$
$\Delta BV_{CES}/\Delta T_J$	Breakdown Voltage Temp. Coefficient	—	0.38	—	V/°C	Reference to $25^\circ\text{C}, I_{CE} = 1\text{mA}$
$V_{CE(on)}$	Static Collector-to-Emitter Voltage	—	1.26	1.43	V	$V_{GE} = 15V, I_{CE} = 20A$ ③
		—	1.34	—		$V_{GE} = 15V, I_{CE} = 25A$ ③
		—	1.65	—		$V_{GE} = 15V, I_{CE} = 45A$ ③
		—	2.02	—		$V_{GE} = 15V, I_{CE} = 70A$ ③
		—	2.79	—		$V_{GE} = 15V, I_{CE} = 120A$ ③
		—	1.39	—		$V_{GE} = 15V, I_{CE} = 25A, T_J = 150^\circ\text{C}$ ③
$V_{GE(th)}$	Gate Threshold Voltage	2.2	—	4.7	V	$V_{CE} = V_{GE}, I_{CE} = 1.3\text{mA}$
$\Delta V_{GE(th)}/\Delta T_J$	Gate Threshold Voltage Coefficient	—	-8.8	—	mV/°C	
I_{CES}	Collector-to-Emitter Leakage Current	—	1.0	20	μA	$V_{CE} = 330V, V_{GE} = 0V$
		—	50	200		$V_{CE} = 330V, V_{GE} = 0V, T_J = 125^\circ\text{C}$
		—	125	—		$V_{CE} = 330V, V_{GE} = 0V, T_J = 150^\circ\text{C}$
I_{GES}	Gate-to-Emitter Forward Leakage	—	—	100	nA	$V_{GE} = 30V$
	Gate-to-Emitter Reverse Leakage	—	—	-100		$V_{GE} = -30V$
g_{fe}	Forward Transconductance	—	55	—	S	$V_{CE} = 25V, I_{CE} = 25A$
Q_g	Total Gate Charge	—	38	—	nC	$V_{CE} = 200V, I_C = 25A, V_{GE} = 15V$ ③
Q_{gc}	Gate-to-Collector Charge	—	13	—		
$t_{d(on)}$	Turn-On delay time	—	16	—	ns	$I_C = 25A, V_{CC} = 196V$ $R_G = 10\Omega, L = 200\mu H$ $T_J = 25^\circ\text{C}$
t_r	Rise time	—	22	—		
$t_{d(off)}$	Turn-Off delay time	—	81	—		
t_f	Fall time	—	105	—		
$t_{d(on)}$	Turn-On delay time	—	16	—	ns	$I_C = 25A, V_{CC} = 196V$ $R_G = 10\Omega, L = 200\mu H$ $T_J = 150^\circ\text{C}$
t_r	Rise time	—	25	—		
$t_{d(off)}$	Turn-Off delay time	—	95	—		
t_f	Fall time	—	203	—		
t_{st}	Shoot Through Blocking Time	100	—	—	ns	$V_{CC} = 240V, V_{GE} = 15V, R_G = 5.1\Omega$
E_{PULSE}	Energy per Pulse	—	854	—	μJ	$L = 220\text{nH}, C = 0.40\mu F, V_{GE} = 15V$ $V_{CC} = 240V, R_G = 5.1\Omega, T_J = 25^\circ\text{C}$
		—	1083	—		$L = 220\text{nH}, C = 0.40\mu F, V_{GE} = 15V$ $V_{CC} = 240V, R_G = 5.1\Omega, T_J = 100^\circ\text{C}$
		—	—	—		
ESD	Human Body Model	Class 1C (Per JEDEC standard JESD22-A114)				
	Machine Model	Class B (Per EIA/JEDEC standard EIA/JESD22-A115)				
C_{ies}	Input Capacitance	—	1098	—	pF	$V_{GE} = 0V$
C_{oes}	Output Capacitance	—	56	—		$V_{CE} = 30V$
C_{res}	Reverse Transfer Capacitance	—	32	—		$f = 1.0\text{MHz}$
L_C	Internal Collector Inductance	—	4.5	—	nH	Between lead, 6mm (0.25in.)
L_E	Internal Emitter Inductance	—	7.5	—		from package and center of die contact

Notes:

- ① Half sine wave with duty cycle = 0.05, $t_{on} = 2\mu\text{sec}$.
- ② R_θ is measured at T_J of approximately 90°C .
- ③ Pulse width $\leq 40\mu\text{s}$; duty cycle $\leq 2\%$.

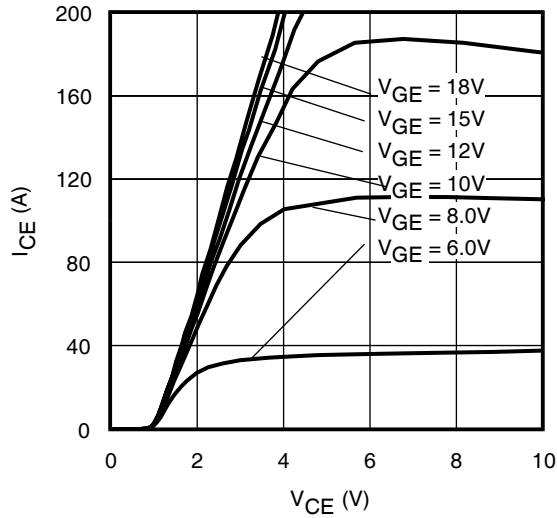

Fig 1. Typical Output Characteristics @ 25°C

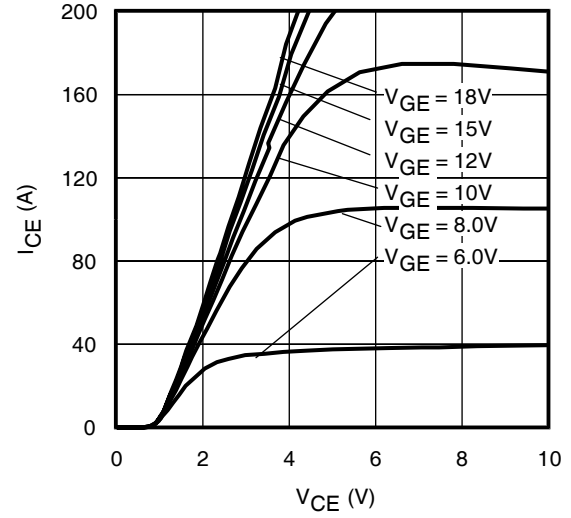

Fig 2. Typical Output Characteristics @ 75°C

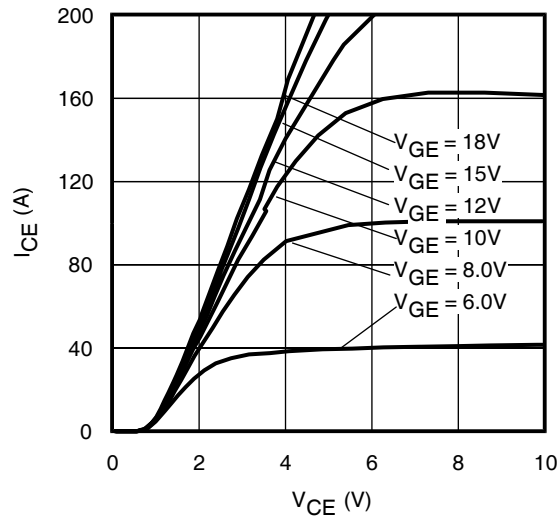

Fig 3. Typical Output Characteristics @ 125°C

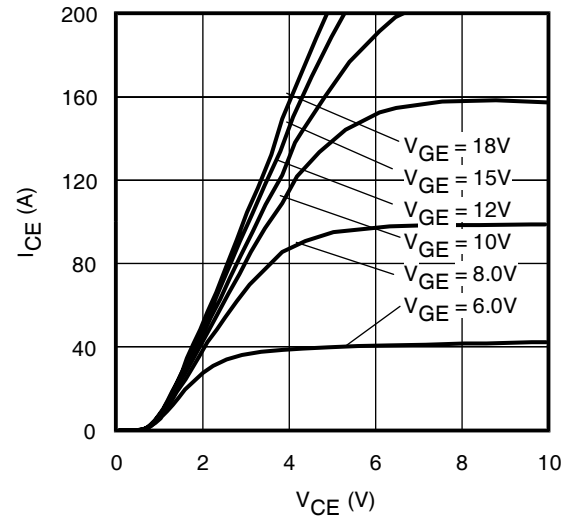

Fig 4. Typical Output Characteristics @ 150°C

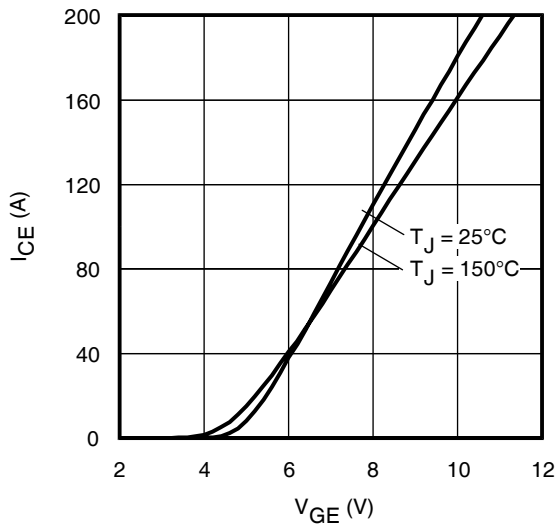

Fig 5. Typical Transfer Characteristics

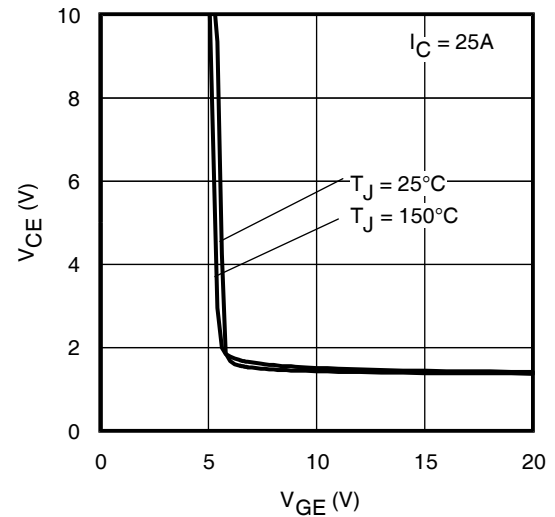

Fig 6. $V_{CE(ON)}$ vs. Gate Voltage

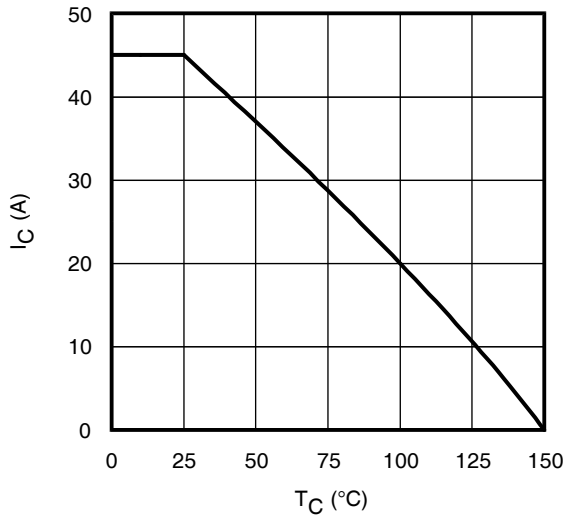

Fig 7. Maximum Collector Current vs. Case Temperature

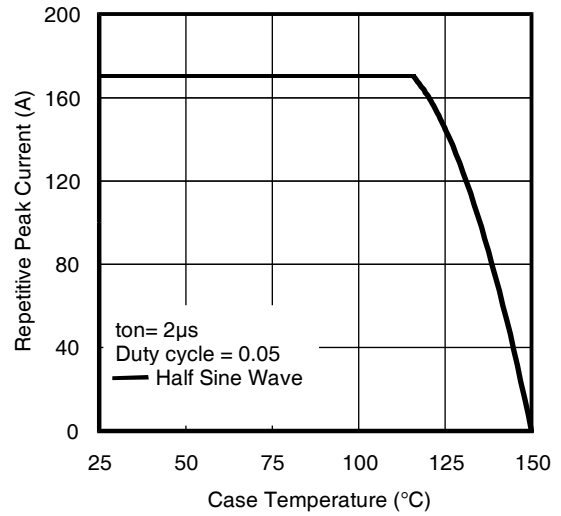

Fig 8. Typical Repetitive Peak Current vs. Case Temperature

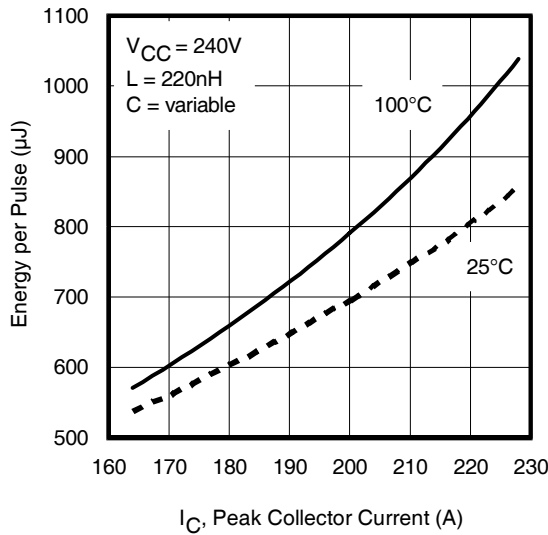

Fig 9. Typical E_{PULSE} vs. Collector Current

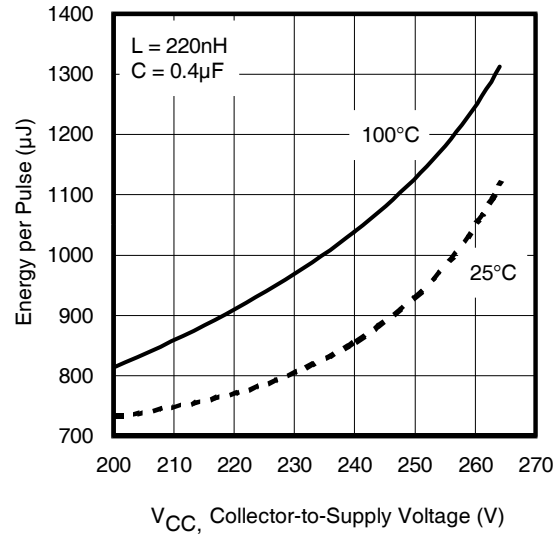

Fig 10. Typical E_{PULSE} vs. Collector-to-Supply Voltage

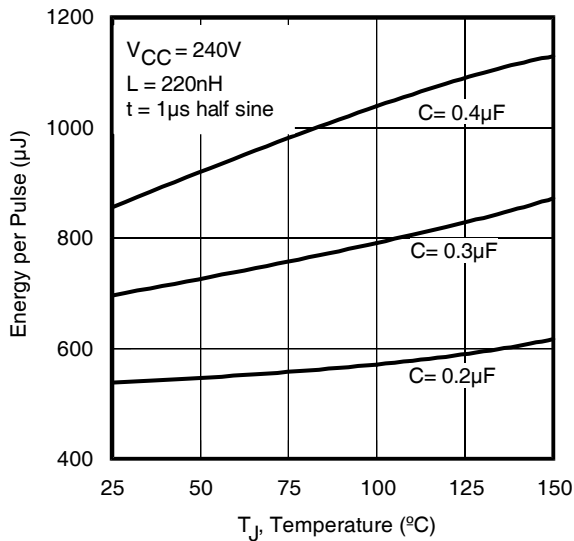

Fig 11. E_{PULSE} vs. Temperature

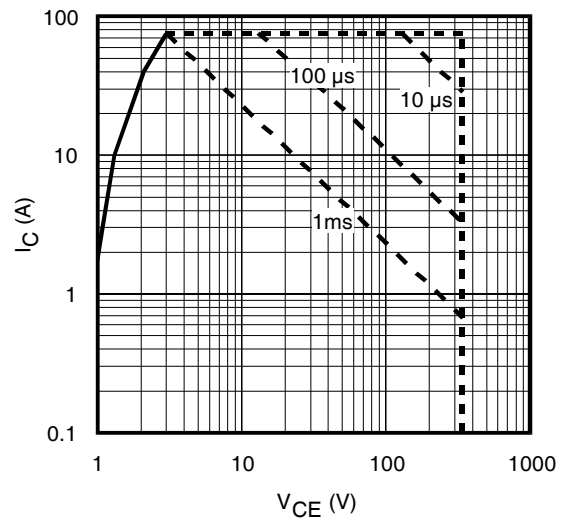

Fig 12. Forward Bias Safe Operating Area

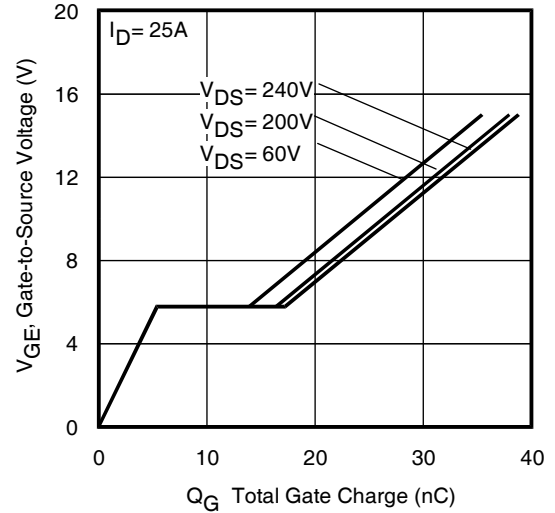
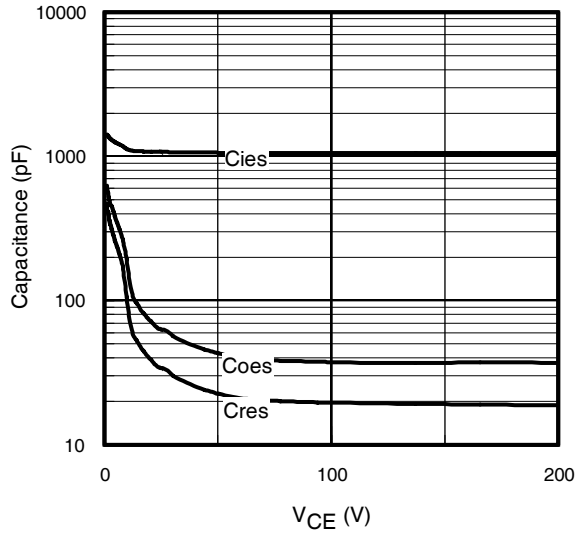

Fig 13. Typical Capacitance vs. Collector-to-Emitter Voltage

Fig 14. Typical Gate Charge vs. Gate-to-Emitter Voltage

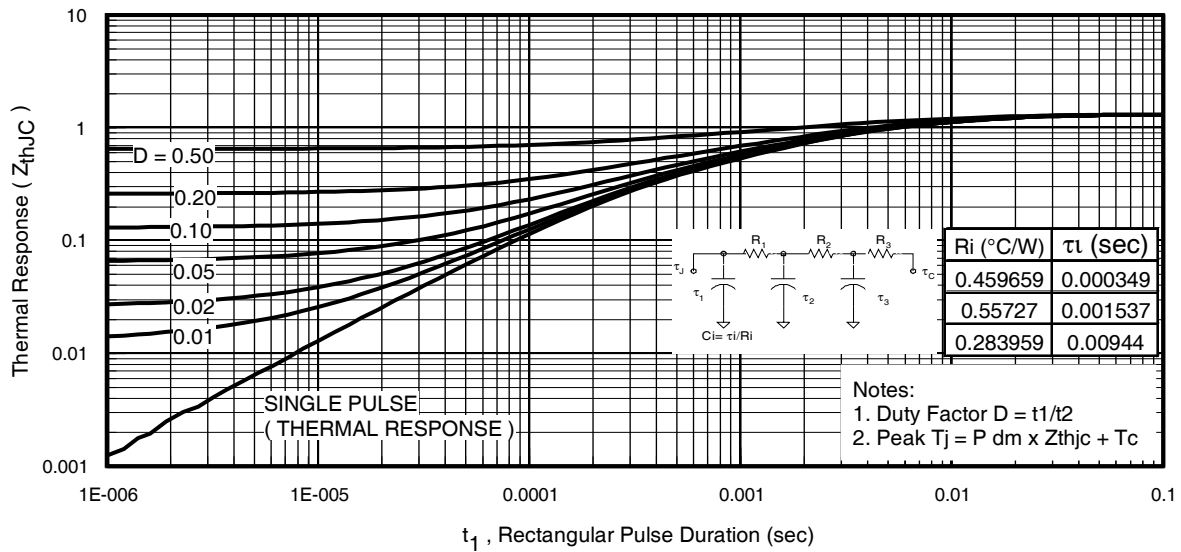

Fig 15. Maximum Effective Transient Thermal Impedance, Junction-to-Case

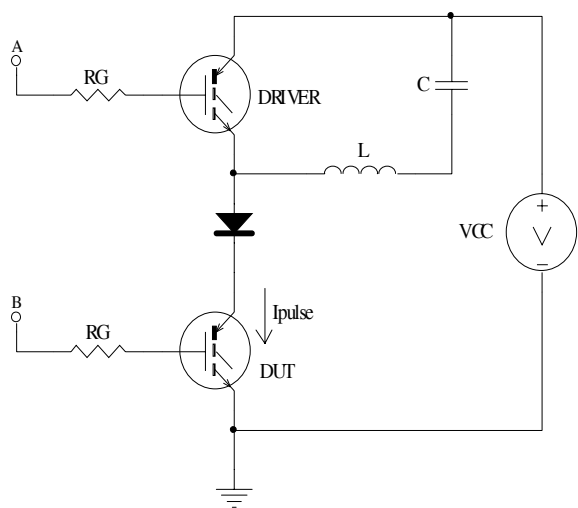

Fig 16a. t_{st} and E_{PULSE} Test Circuit

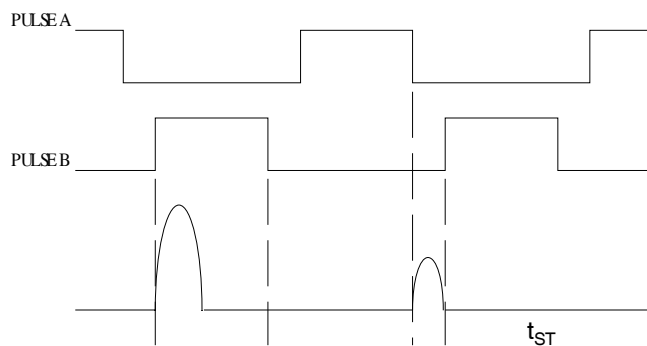

Fig 16b. t_{st} Test Waveforms

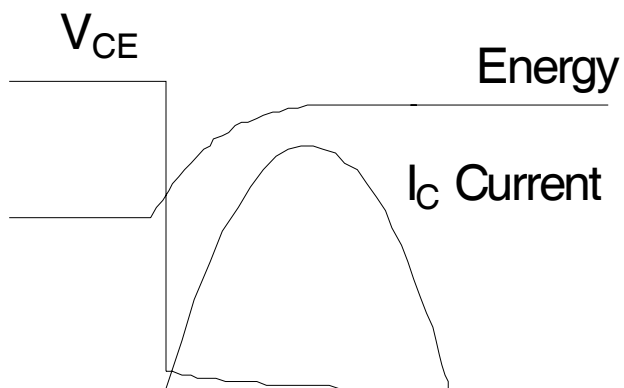

Fig 16c. E_{PULSE} Test Waveforms

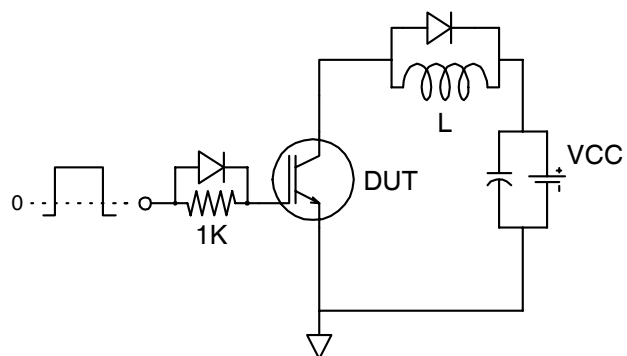
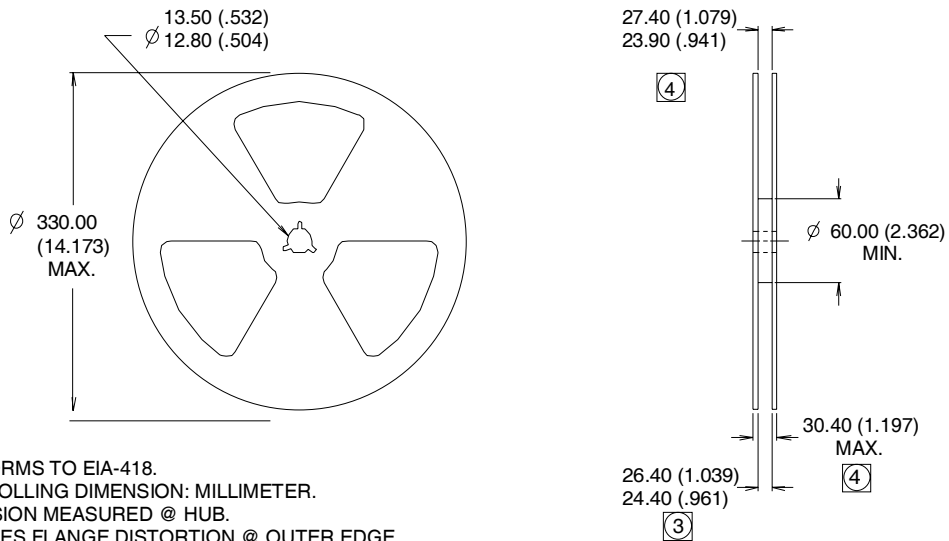
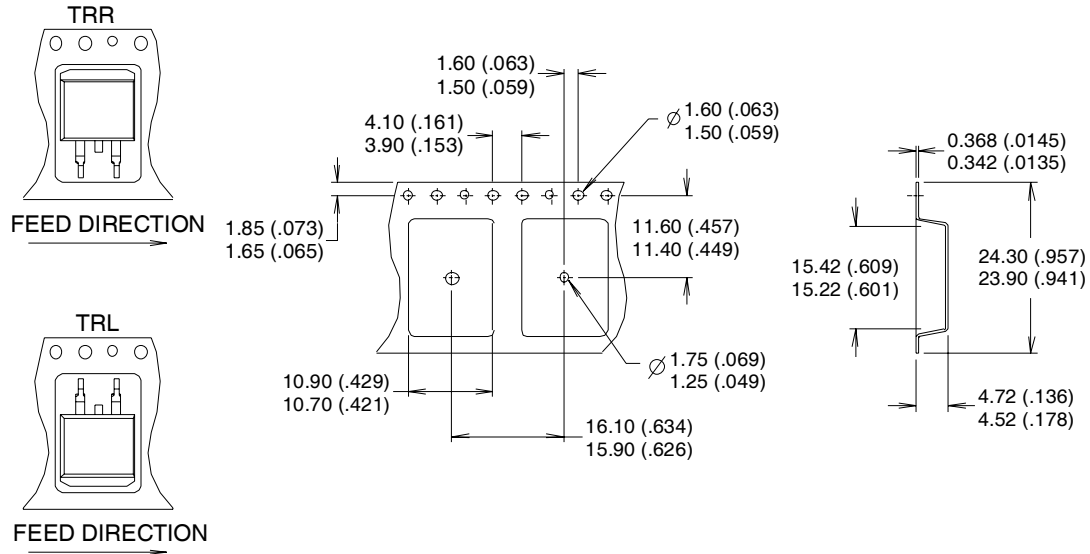

Fig. 17 - Gate Charge Circuit (turn-off)

D²Pak (TO-263AB) Tape & Reel Information

Dimensions are shown in millimeters (inches)



- NOTES :
1. CONFORMS TO EIA-418.
 2. CONTROLLING DIMENSION: MILLIMETER.
 - ③ DIMENSION MEASURED @ HUB.
 - ④ INCLUDES FLANGE DISTORTION @ OUTER EDGE.

Note: For the most current drawing please refer to IR website at <http://www.irf.com/package/>

Data and specifications subject to change without notice.
This product has been designed for the Industrial market.
Qualification Standards can be found on IR's Web site.