

N-CHANNEL SILICON POWER MOSFET Trench Power MOSFET

■ Features

- High speed switching
- Low on-resistance
- No secondary breakdown
- Low driving power
- Avalanche-proof

■ Applications

- Switching regulators
- DC-DC converters
- General purpose power amplifier

■ Maximum ratings and characteristics

● Absolute maximum ratings (Tc=25°C unless otherwise specified)

Item	Symbol	Rating	Unit	Remarks
Drain-source voltage	V _{DS}	60	V	
	V _{DSX}	30	V	V _{GS} =-20V
Continuous drain current	I _D	±100	A	
Pulsed drain current	I _D [puls]	±400	A	
Gate-source peak voltage	V _{GS}	+30/-20	V	
Maximum avalanche energy	E _{AV}	387.4	mJ	*1
Maximum power dissipation	P _D	155	W	
Operating and storage temperature range	T _{ch}	+150	°C	
	T _{stg}	-55 to +150	°C	

*1 L=51.7μH, V_{CC}=24V

● Electrical characteristics (Tc =25°C unless otherwise specified)

Item	Symbol	Test Conditions	Min.	Typ.	Max.	Units
Drain-source breakdown voltage	BV _{DSS}	I _D =1mA V _{GS} =0V	60			V
	BV _{DSX}	I _D =1mA V _{GS} =-20V	30			V
Gate threshold voltage	V _{GS(th)}	I _D =10mA V _{DS} =V _{GS}	2.5	3.0	3.5	V
Zero gate voltage drain current	I _{DSS}	V _{DS} =60V V _{GS} =0V	T _{ch} =25°C	1.0	100	μA
			T _{ch} =125°C	10	500	μA
Gate-source leakage current	I _{GSS}	V _{GS} =+30V,-20V V _{DS} =0V		10	100	nA
Drain-source on-state resistance	R _{DSON}	I _D =50A V _{GS} =10V		5.0	6.5	mΩ
Forward transconductance	g _{fs}	I _D =50A V _{DS} =10V	25	50		S
Input capacitance	C _{iss}	V _{DS} =25V		9000		pF
Output capacitance	C _{oss}	V _{GS} =0V		1250		
Reverse transfer capacitance	C _{rss}	f=1MHz		700		
Turn-on time	t _{d(on)}	V _{CC} =30V R _G =10 Ω		50		ns
	t _r	I _D =100A		200		
Turn-off time	t _{d(off)}	V _{GS} =10V		150		ns
	t _f			135		
Total gate charge	Q _g	V _{CC} =30V		145		nC
Gate-Source charge	Q _{gs}	I _D =100A		60		
Gate-Drain charge	Q _{gd}	V _{GS} =10V		40		
Avalanche capability	I _{AV}	L=100μH T _{ch} =25°C	100			A
Diode forward on-voltage	V _{SD}	I _F =100A V _{GS} =0V T _{ch} =25°C		1.0	1.5	V
Reverse recovery time	t _{rr}	I _F =50A V _{GS} =0V		85		ns
Reverse recovery charge	Q _{rr}	-di/dt=100A/μs T _{ch} =25°C		0.25		μC

● Thermal characteristics

Item	Symbol	Min.	Typ.	Max.	Units
Thermal resistance	R _{th(ch-c)}			0.806	°C/W
	R _{th(ch-a)}			50.0	°C/W

■ Outline Drawings

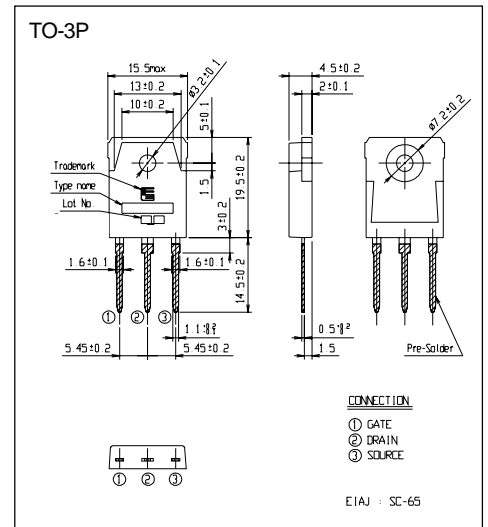

■ Equivalent circuit schematic

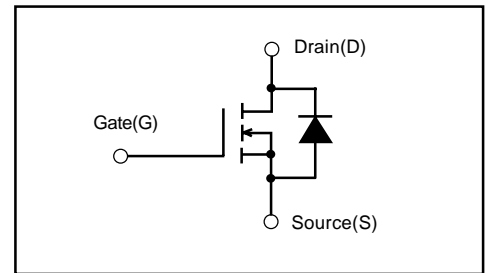

Characteristics

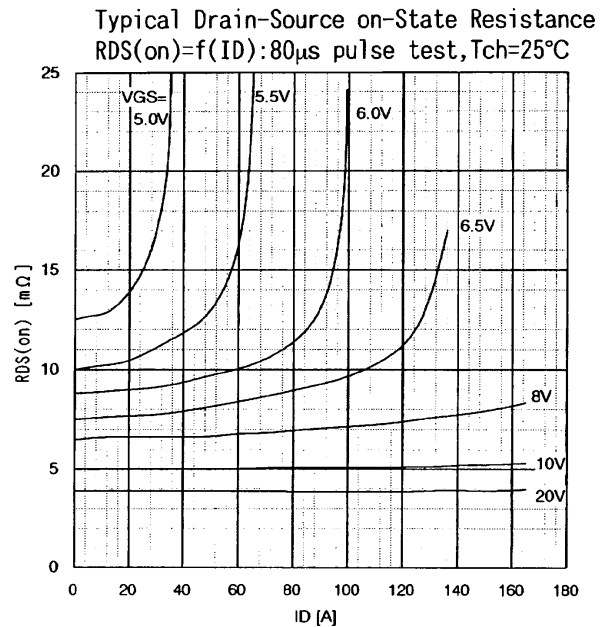
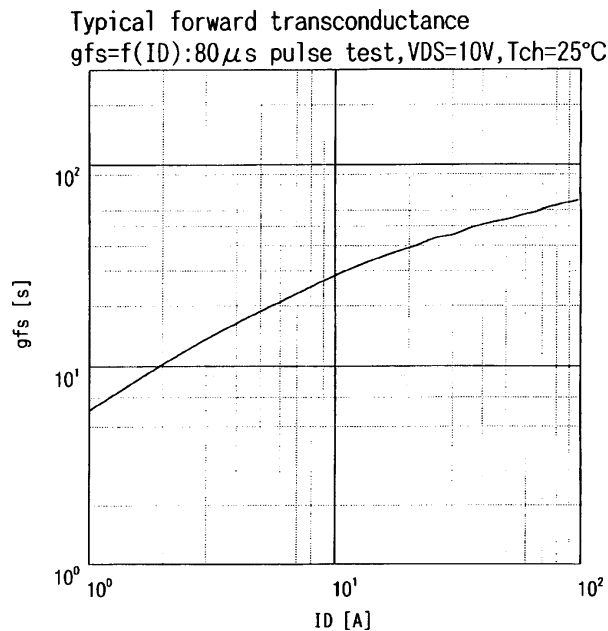
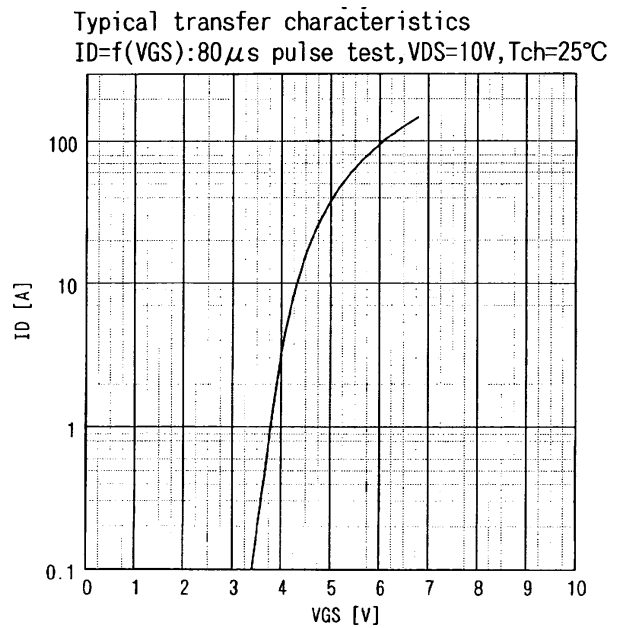
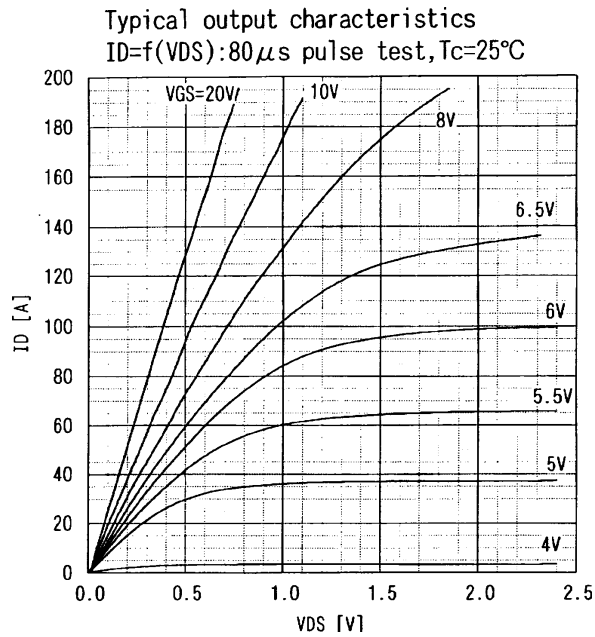
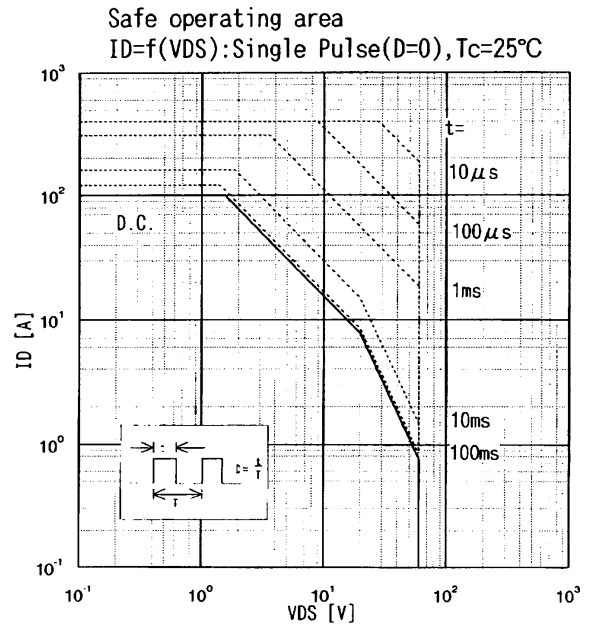
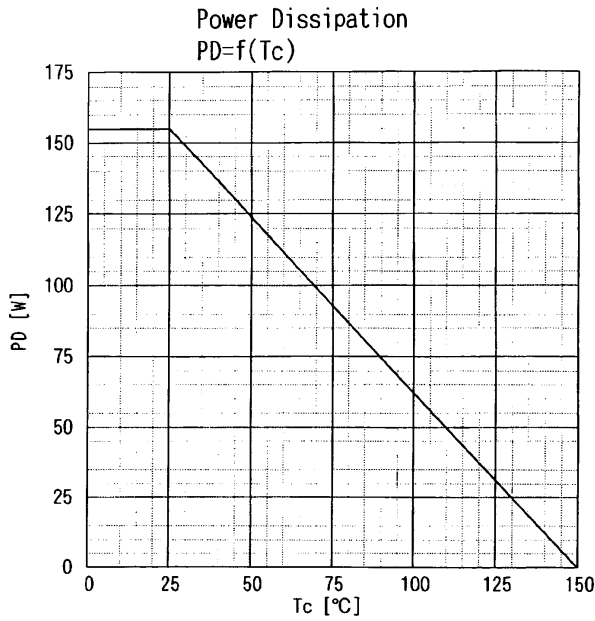

Drain-source on-state resistance
 $R_{DS(on)} = f(T_{ch}) : I_D = 50A, V_{GS} = 10V$

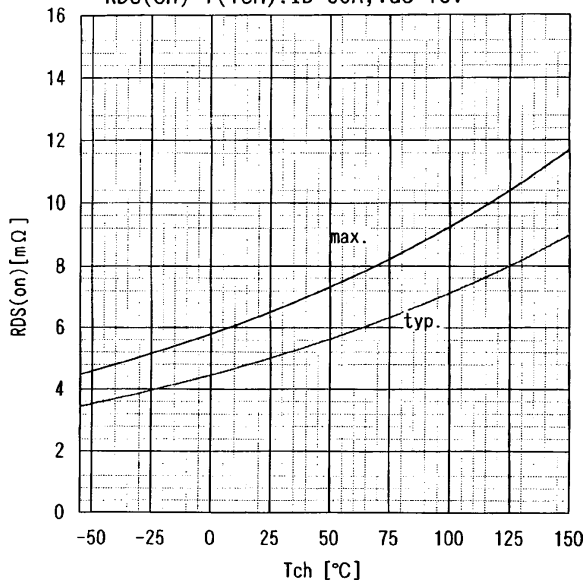

Gate Threshold Voltage vs. Tch
 $V_{GS(th)} = f(T_{ch}) : V_{DS} = V_{GS}, I_D = 10mA$

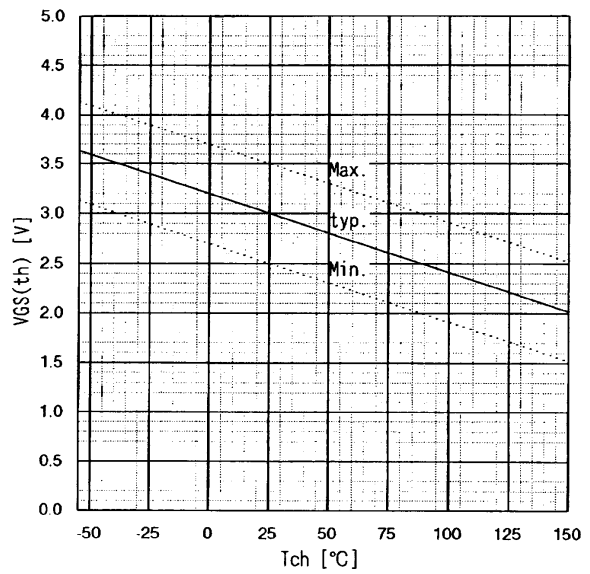

Typical capacitances
 $C = f(V_{DS}) : V_{GS} = 0V, f = 1MHz$

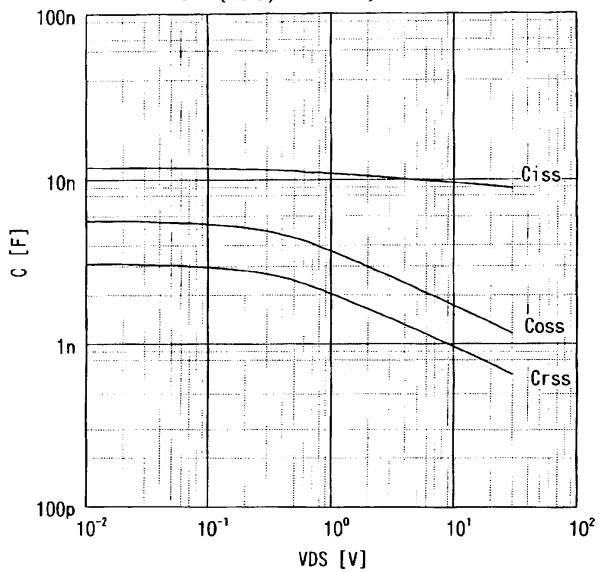

Maximum Avalanche Current vs. starting Tch
 $I_{(AV)} = f(\text{starting } Tch), \text{ single pulse}$

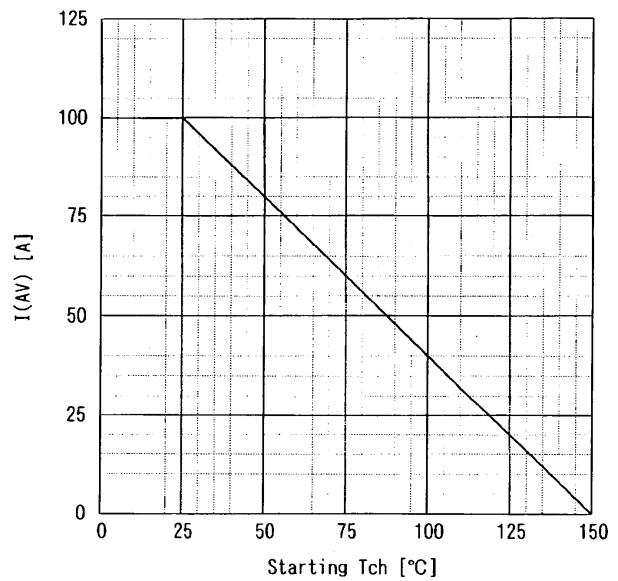

Maximum Avalanche energy vs. starting Tch
 $E_{as} = f(\text{starting } Tch) : V_{CC} = 24V, I_{AV} \le 100A, \text{ single pulse}$

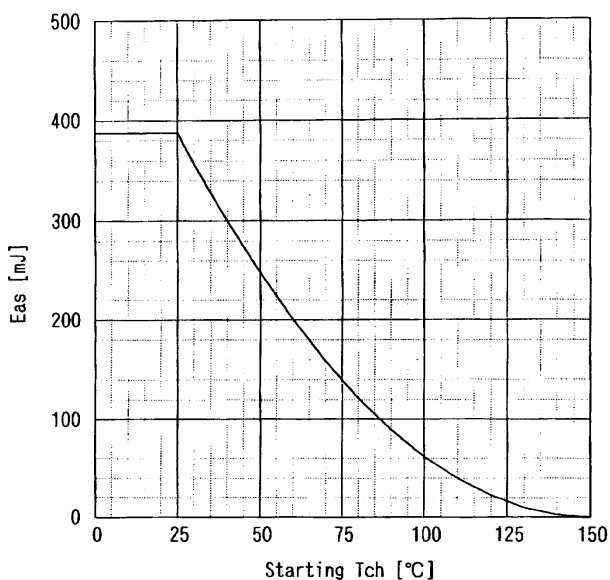

Typical Gate Charge Characteristics
 $V_{GS} = f(Q_g) : I_D = 100A, Tch = 25°C$

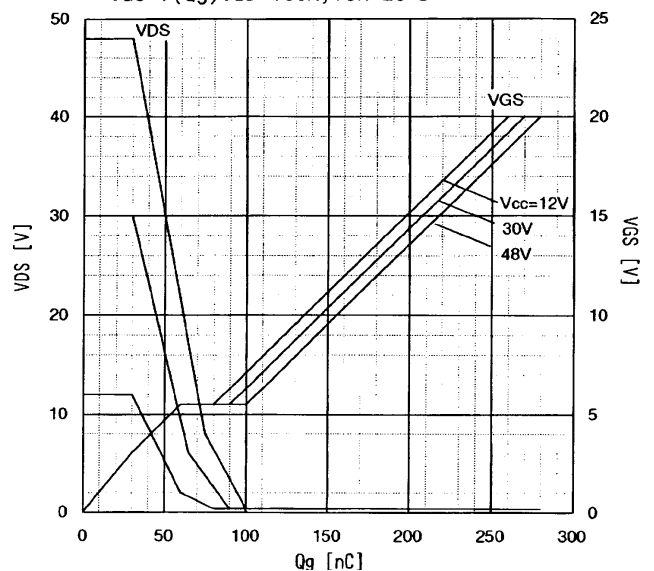

Typical Forward Characteristics of Reverse Diode
 $-I_D=f(V_{SD}): 80\mu s$ pulse test, $T_{ch}=25^\circ C$

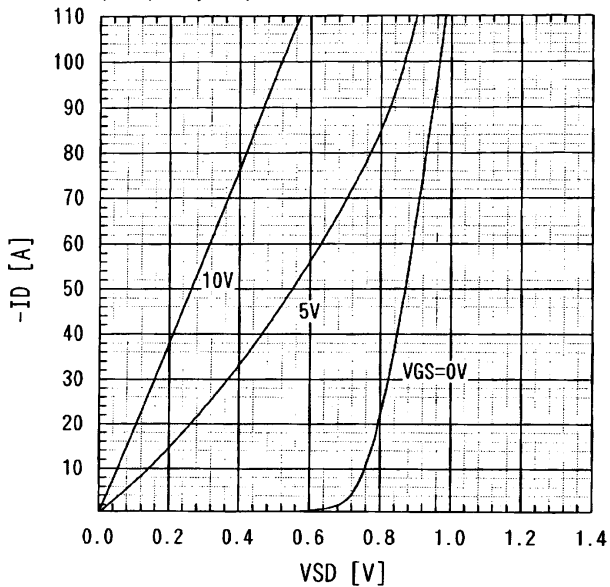

Typical Switching Characteristics vs. I_D
 $t=f(I_D): V_{cc}=30V, V_{GS}=10V, R_G=10\Omega$

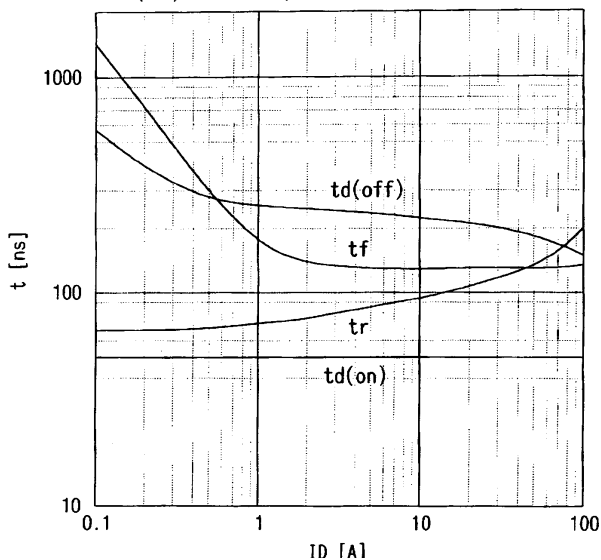

Drain-Source Breakdown Voltage vs. V_{GS}
 $BV_{DSX}=f(V_{GS}): T_{ch}=25^\circ C$

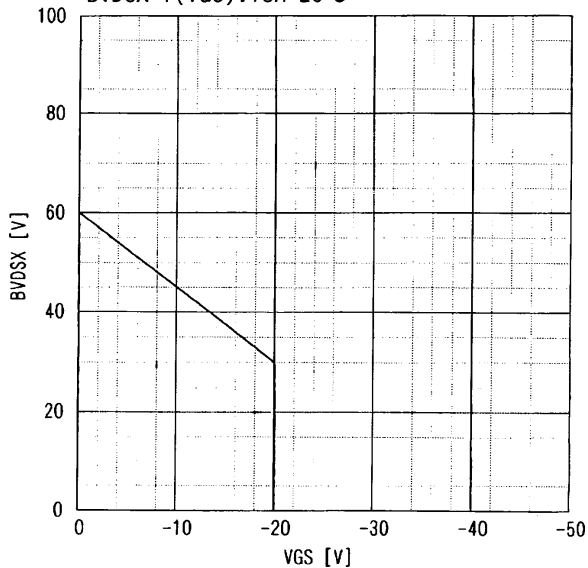

Transient Thermal Impedance
 $Z_{th(ch-c)}=f(t): D=t/T$

