



STP9NC65 STP9NC65FP

N-CHANNEL 650V - 0.75Ω - 8A TO-220/TO-220FP
PowerMesh™II MOSFET

TYPE	V _{DSS}	R _{DS(on)}	I _D
STP9NC65	650 V	< 0.90 Ω	8 A
STP9NC65FP	650 V	< 0.90 Ω	8 A

- TYPICAL R_{DS(on)} = 0.75 Ω
- EXTREMELY HIGH dv/dt CAPABILITY
- 100% AVALANCHE TESTED
- NEW HIGH VOLTAGE BENCHMARK
- GATE CHARGE MINIMIZED

DESCRIPTION

The PowerMESH™II is the evolution of the first generation of MESH OVERLAY™. The layout refinements introduced greatly improve the Ron*area figure of merit while keeping the device at the leading edge for what concerns switching speed, gate charge and ruggedness.

APPLICATIONS

- HIGH CURRENT, HIGH SPEED SWITCHING
- SWITCH MODE POWER SUPPLIES (SMPS)
- DC-AC CONVERTERS FOR WELDING EQUIPMENT AND UNINTERRUPTIBLE POWER SUPPLIES AND MOTOR DRIVES

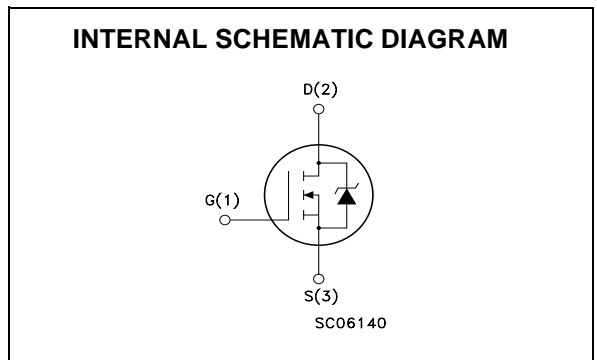
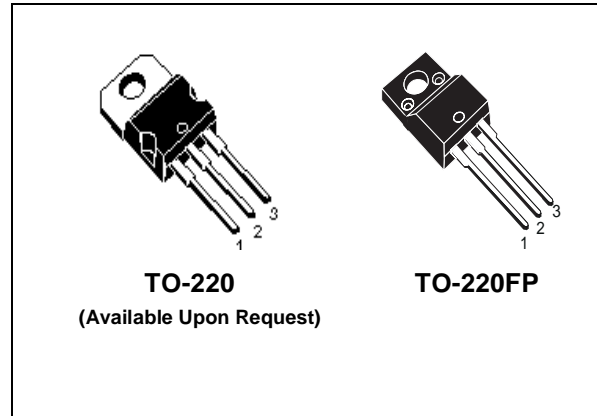

ABSOLUTE MAXIMUM RATINGS

Symbol	Parameter	Value		Unit
		STP9NC65	STP9NC65FP	
V _{DS}	Drain-source Voltage (V _{GS} = 0)	650		V
V _{DGR}	Drain-gate Voltage (R _{GS} = 20 kΩ)	650		V
V _{GS}	Gate- source Voltage	±30		V
I _D	Drain Current (continuous) at T _C = 25°C	8	8(*)	A
I _D	Drain Current (continuous) at T _C = 100°C	5	5(*)	A
I _{DM} (●)	Drain Current (pulsed)	32	32(*)	A
P _{TOT}	Total Dissipation at T _C = 25°C	140	40	W
	Derating Factor	1.12	0.32	W/°C
dv/dt (1)	Peak Diode Recovery voltage slope	3.5		V/ns
V _{ISO}	Insulation Withstand Voltage (DC)	-	2000	V
T _{stg}	Storage Temperature	-65 to 150		°C
T _j	Max. Operating Junction Temperature	150		°C

(*)Pulse width limited by safe operating area

(*) Limited only by maximum temperature allowed

(1)I_{SD} ≤ 8A, di/dt ≤ 100A/μs, V_{DD} ≤ V_{(BR)DSS}, T_j ≤ T_{JMAX}.

STP9NC65/FP

THERMAL DATA

		TO-220	TO-220FP	
Rthj-case	Thermal Resistance Junction-case Max	0.89	3.12	°C/W
Rthj-amb	Thermal Resistance Junction-ambient Max	62.5		°C/W
Rthc-sink	Thermal Resistance Case-sink Typ	0.5		°C/W
T _l	Maximum Lead Temperature For Soldering Purpose	300		°C

AVALANCHE CHARACTERISTICS

Symbol	Parameter	Max Value	Unit
I _{AR}	Avalanche Current, Repetitive or Not-Repetitive (pulse width limited by T _j max)	8	A
E _{AS}	Single Pulse Avalanche Energy (starting T _j = 25 °C, I _D = I _{AR} , V _{DD} = 50 V)	850	mJ

ELECTRICAL CHARACTERISTICS (TCASE = 25 °C UNLESS OTHERWISE SPECIFIED)

OFF

Symbol	Parameter	Test Conditions	Min.	Typ.	Max.	Unit
V _{(BR)DSS}	Drain-source Breakdown Voltage	I _D = 250 μA, V _{GS} = 0	650			V
I _{DSS}	Zero Gate Voltage Drain Current (V _{GS} = 0)	V _{DS} = Max Rating V _{DS} = Max Rating, T _C = 125 °C			1 50	μA μA
I _{GSS}	Gate-body Leakage Current (V _{DS} = 0)	V _{GS} = ±30V			±100	nA

ON (1)

Symbol	Parameter	Test Conditions	Min.	Typ.	Max.	Unit
V _{GS(th)}	Gate Threshold Voltage	V _{DS} = V _{GS} , I _D = 250μA	2	3	4	V
R _{DS(on)}	Static Drain-source On Resistance	V _{GS} = 10V, I _D = 4.5 A		0.75	0.90	Ω
I _{D(on)}	On State Drain Current	V _{DS} > I _{D(on)} × R _{DS(on)max} , V _{GS} = 10V	8			A

DYNAMIC

Symbol	Parameter	Test Conditions	Min.	Typ.	Max.	Unit
g _{fs} (1)	Forward Transconductance	V _{DS} > I _{D(on)} × R _{DS(on)max} , I _D = 4.5A		10		S
C _{iss}	Input Capacitance	V _{DS} = 25V, f = 1 MHz, V _{GS} = 0		1400		pF
C _{oss}	Output Capacitance			196		pF
C _{rss}	Reverse Transfer Capacitance			31		pF

ELECTRICAL CHARACTERISTICS (CONTINUED)

SWITCHING ON

Symbol	Parameter	Test Conditions	Min.	Typ.	Max.	Unit
$t_{d(on)}$	Turn-on Delay Time	$V_{DD} = 325\text{ V}$, $I_D = 4.5\text{ A}$ $R_G = 4.7\Omega$, $V_{GS} = 10\text{ V}$ (see test circuit, Figure 3)		28		ns
t_r	Rise Time			15		ns
Q_g	Total Gate Charge	$V_{DD} = 520\text{ V}$, $I_D = 9\text{ A}$, $V_{GS} = 10\text{ V}$		44	62	nC
Q_{gs}	Gate-Source Charge			10.5		nC
Q_{gd}	Gate-Drain Charge			19.5		nC

SWITCHING OFF

Symbol	Parameter	Test Conditions	Min.	Typ.	Max.	Unit
$t_{d(off)}$	Turn-Off Delay Time	$V_{DD} = 325\text{ V}$, $I_D = 4.5\text{ A}$, $R_G = 4.7\Omega$, $V_{GS} = 10\text{ V}$ (see test circuit, Figure 3)		53		ns
t_f	Fall Time			30		ns
$t_{r(Voff)}$	Off-voltage Rise Time	$V_{DD} = 520\text{ V}$, $I_D = 9\text{ A}$, $R_G = 4.7\Omega$, $V_{GS} = 10\text{ V}$ (see test circuit, Figure 5)		15		ns
t_f	Fall Time			12		ns
t_c	Cross-over Time			24		ns

SOURCE DRAIN DIODE

Symbol	Parameter	Test Conditions	Min.	Typ.	Max.	Unit
I_{SD}	Source-drain Current				8	A
$I_{SDM(2)}$	Source-drain Current (pulsed)				32	A
$V_{SD(1)}$	Forward On Voltage	$I_{SD} = 8\text{ A}$, $V_{GS} = 0$			1.6	V
t_{rr}	Reverse Recovery Time	$I_{SD} = 9\text{ A}$, $di/dt = 100\text{ A}/\mu\text{s}$ $V_{DD} = 100\text{ V}$, $T_J = 150^\circ\text{C}$ (see test circuit, Figure 5)		610		ns
Q_{rr}	Reverse Recovery Charge			5.14		μC
I_{RRM}	Reverse Recovery Current			17		A

Note: 1. Pulsed: Pulse duration = 300 μs , duty cycle 1.5 %.
2. Pulse width limited by safe operating area.

Safe Operating Area for TO-220

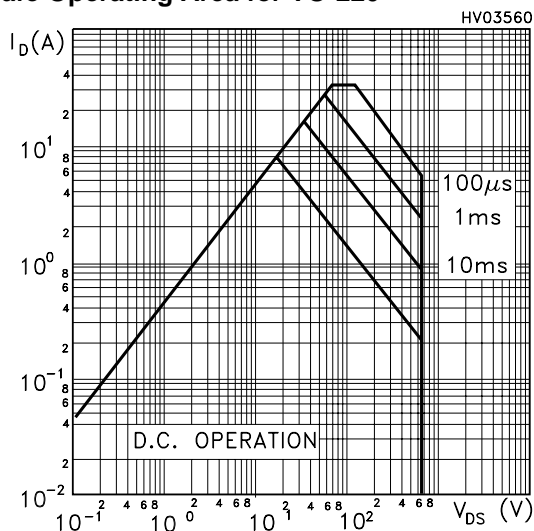

Safe Operating Area for TO-220FP

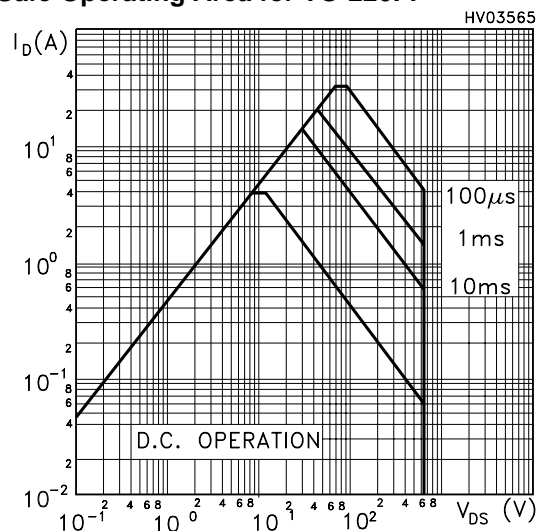

Thermal Impedance for TO-220

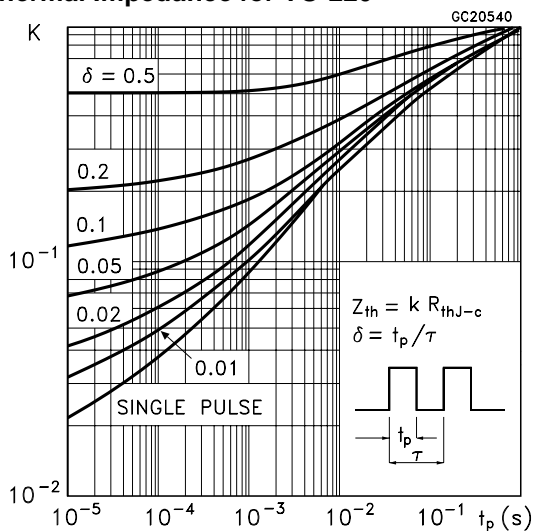

Thermal Impedance for TO-220FP

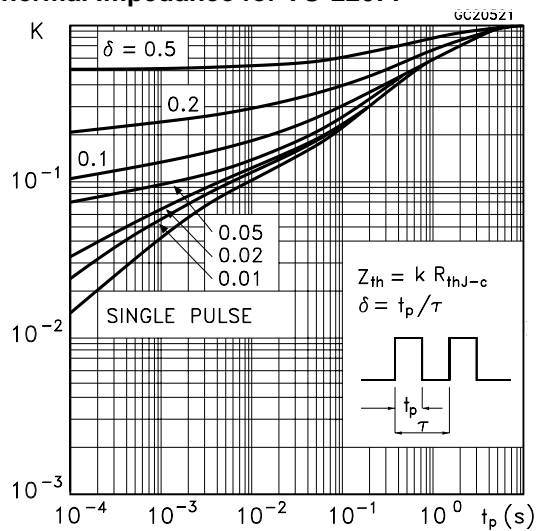

Output Characteristics

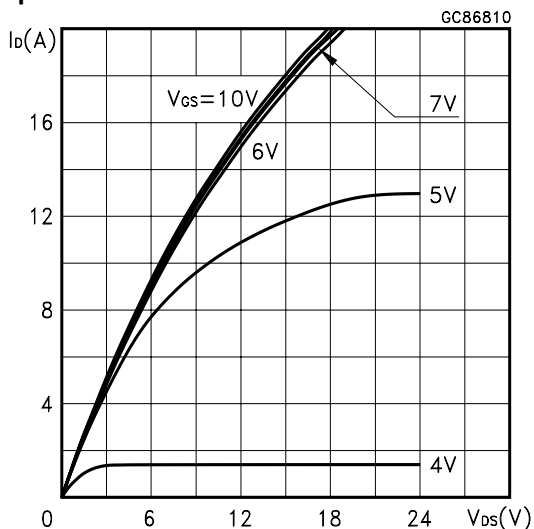

Transfer Characteristics

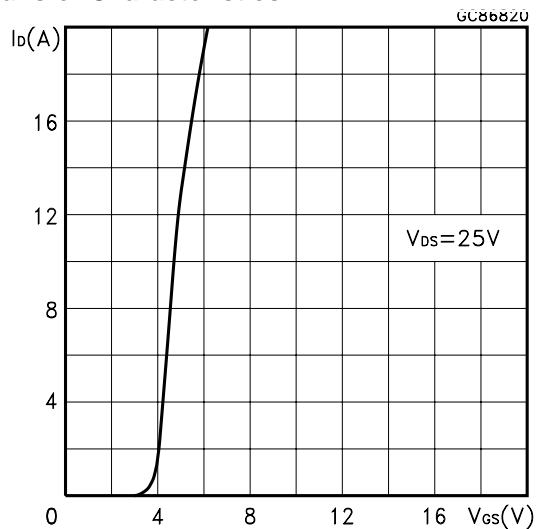

Transconductance

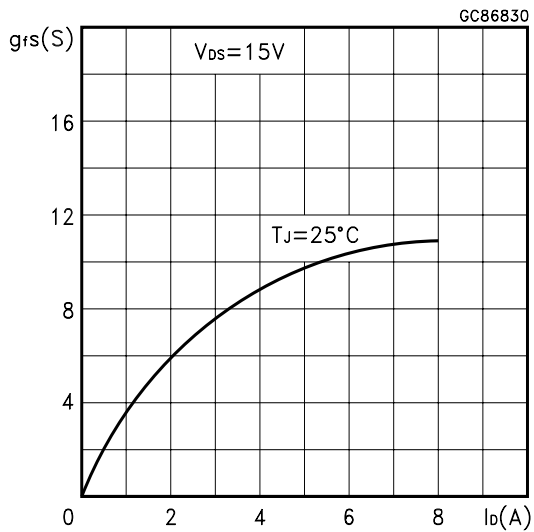

Static Drain-source On Resistance

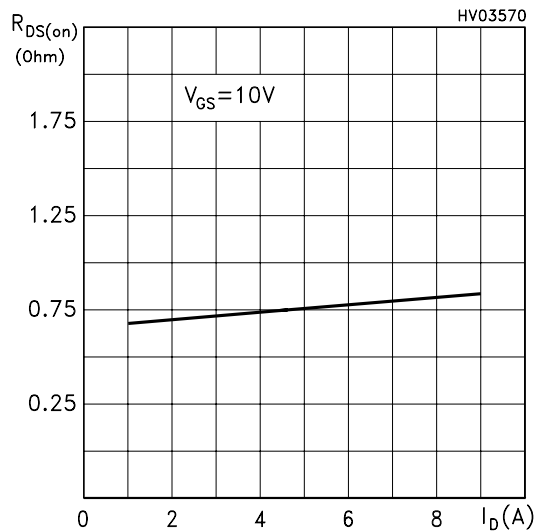

Gate Charge vs Gate-source Voltage

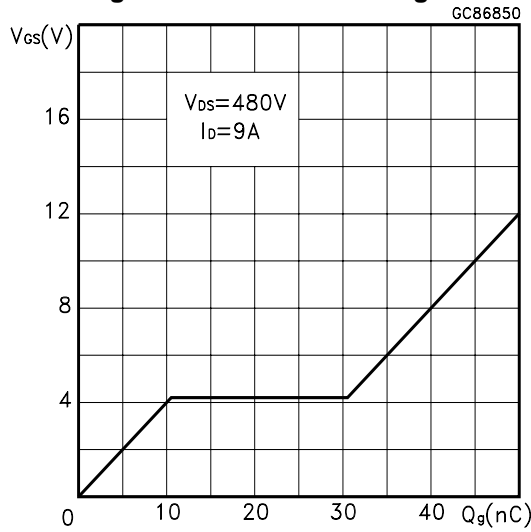

Capacitance Variations

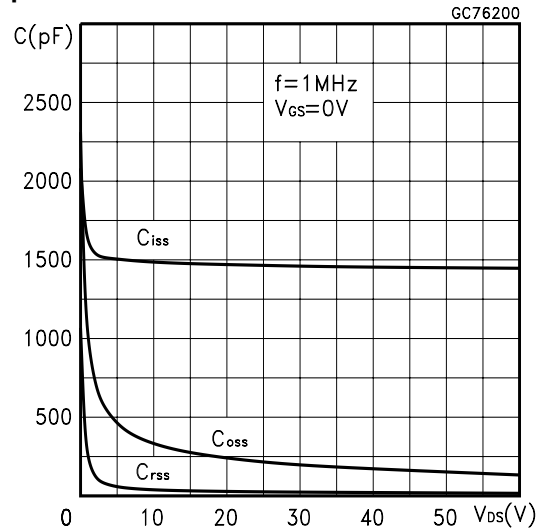

Normalized Gate Threshold Voltage vs Temp.

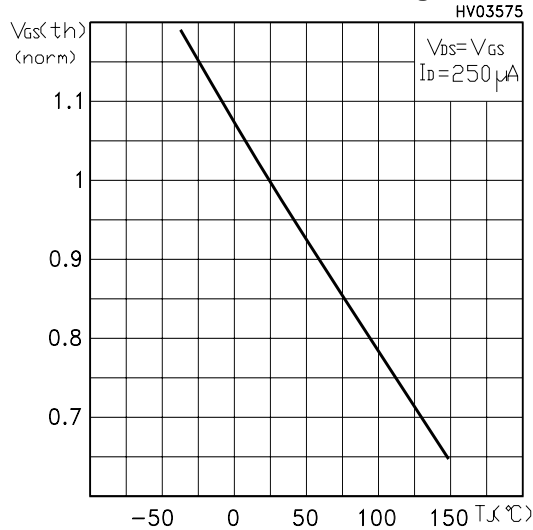

Normalized On Resistance vs Temperature

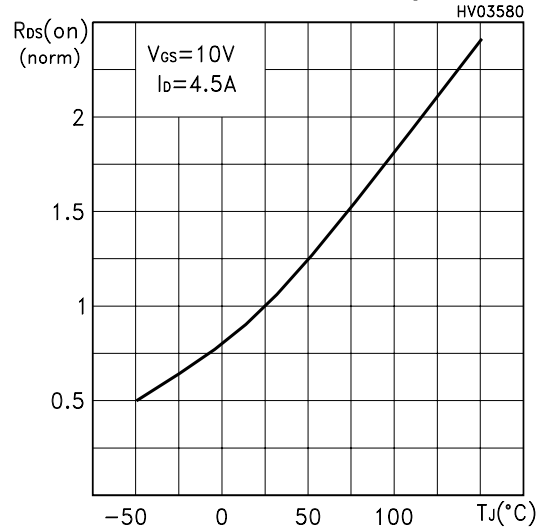

Source-drain Diode Forward Characteristics

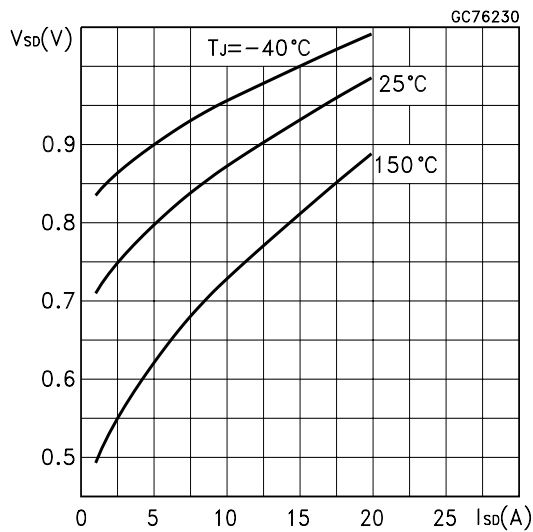

Fig. 1: Unclamped Inductive Load Test Circuit



Fig. 2: Unclamped Inductive Waveform



Fig. 3: Switching Times Test Circuit For Resistive Load



Fig. 4: Gate Charge test Circuit

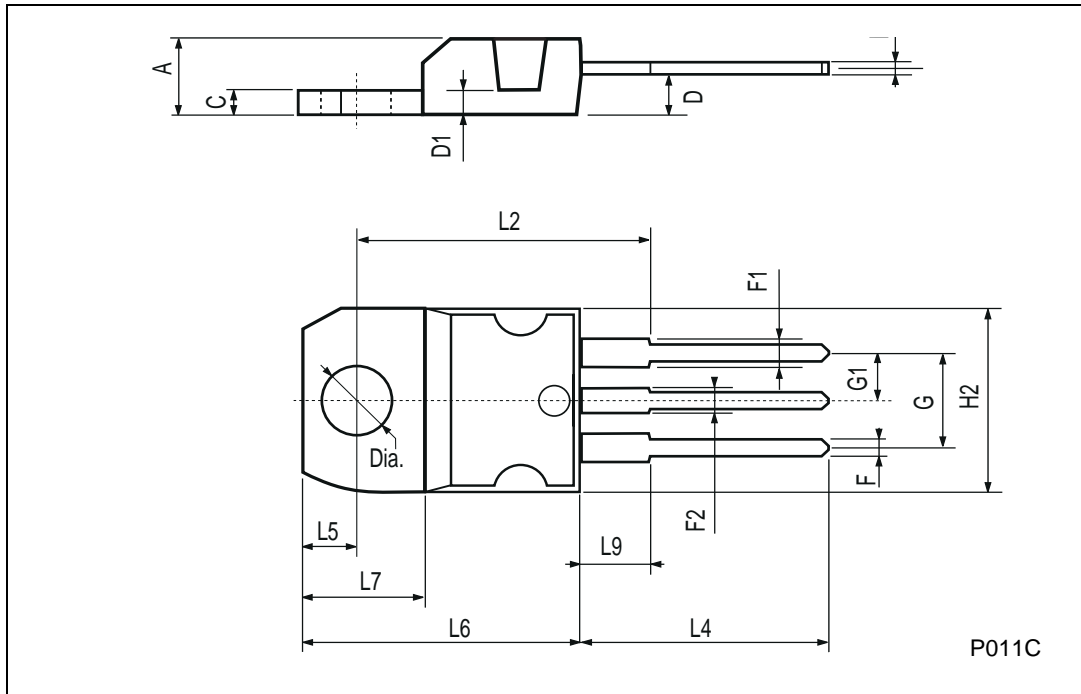

Fig. 5: Test Circuit For Inductive Load Switching And Diode Recovery Times



TO-220 MECHANICAL DATA

DIM.	mm			inch		
	MIN.	TYP.	MAX.	MIN.	TYP.	MAX.
A	4.40		4.60	0.173		0.181
C	1.23		1.32	0.048		0.051
D	2.40		2.72	0.094		0.107
D1		1.27			0.050	
E	0.49		0.70	0.019		0.027
F	0.61		0.88	0.024		0.034
F1	1.14		1.70	0.044		0.067
F2	1.14		1.70	0.044		0.067
G	4.95		5.15	0.194		0.203
G1	2.4		2.7	0.094		0.106
H2	10.0		10.40	0.393		0.409
L2		16.4			0.645	
L4	13.0		14.0	0.511		0.551
L5	2.65		2.95	0.104		0.116
L6	15.25		15.75	0.600		0.620
L7	6.2		6.6	0.244		0.260
L9	3.5		3.93	0.137		0.154
DIA.	3.75		3.85	0.147		0.151



TO-220FP MECHANICAL DATA

DIM.	mm			inch		
	MIN.	TYP.	MAX.	MIN.	TYP.	MAX.
A	4.4		4.6	0.173		0.181
B	2.5		2.7	0.098		0.106
D	2.5		2.75	0.098		0.108
E	0.45		0.7	0.017		0.027
F	0.75		1	0.030		0.039
F1	1.15		1.7	0.045		0.067
F2	1.15		1.7	0.045		0.067
G	4.95		5.2	0.195		0.204
G1	2.4		2.7	0.094		0.106
H	10		10.4	0.393		0.409
L2		16			0.630	
L3	28.6		30.6	1.126		1.204
L4	9.8		10.6	0.385		0.417
L6	15.9		16.4	0.626		0.645
L7	9		9.3	0.354		0.366
∅	3		3.2	0.118		0.126

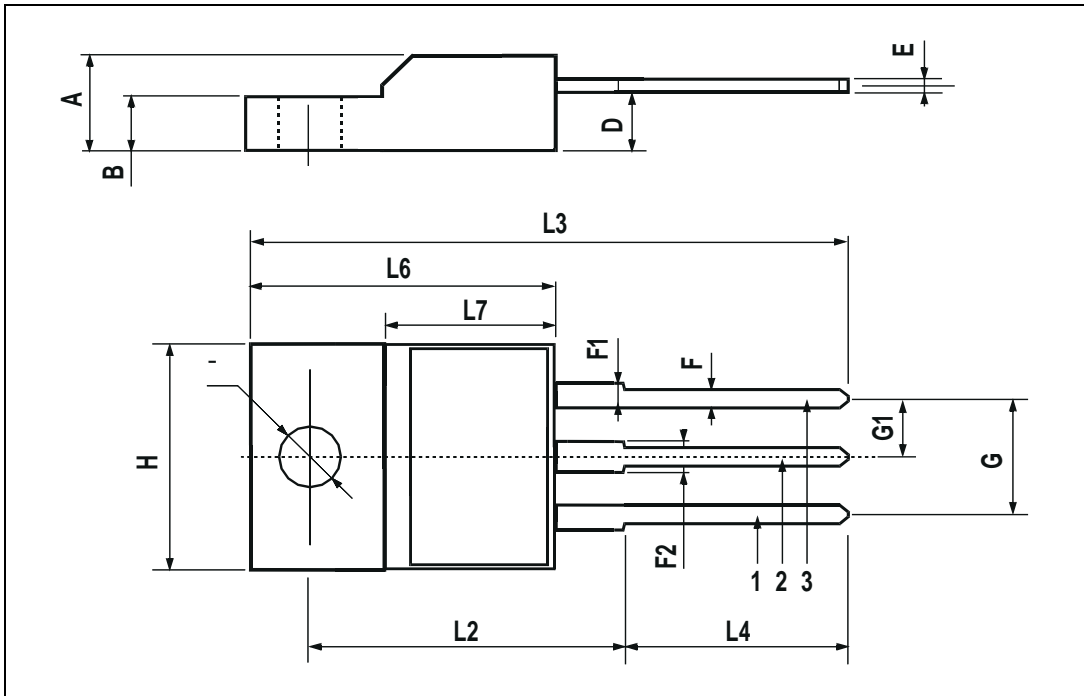

Information furnished is believed to be accurate and reliable. However, STMicroelectronics assumes no responsibility for the consequences of use of such information nor for any infringement of patents or other rights of third parties which may result from its use. No license is granted by implication or otherwise under any patent or patent rights of STMicroelectronics. Specification mentioned in this publication are subject to change without notice. This publication supersedes and replaces all information previously supplied. STMicroelectronics products are not authorized for use as critical components in life support devices or systems without express written approval of STMicroelectronics.

The ST logo is a trademark of STMicroelectronics

© 2000 STMicroelectronics – Printed in Italy – All Rights Reserved

STMicroelectronics GROUP OF COMPANIES

Australia - Brazil - China - Finland - France - Germany - Hong Kong - India - Italy - Japan - Malaysia - Malta - Morocco -
Singapore - Spain - Sweden - Switzerland - United Kingdom - U.S.A.

<http://www.st.com>