

10A 200V Cathode Common

SBD Type : FCH10A20

OUTLINE DRAWING

For High Frequency Rectification

FEATURES

- * High VRM SBD
- * Low Forward Voltage Drop and Low Noise
- * Fully Molded Isolation
- * Dual Diodes Cathode Common

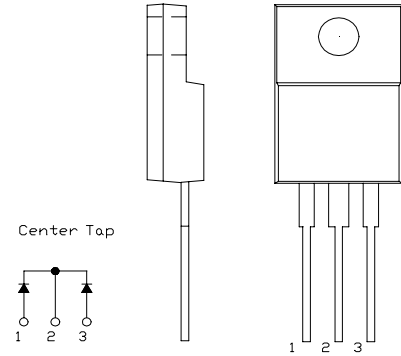

Maximum Ratings

Approx Net Weight:1.75g

Rating	Symbol	FCH10A20		Unit
Repetitive Peak Reverse Voltage	V_{RRM}	200		V
Average Rectified Output Current	I_O	10	$T_c=118^{\circ}C$ 50 Hz, Full Sine Wave Resistive Load	A
RMS Forward Current	$I_{F(RMS)}$	11.1		A
Surge Forward Current	I_{FSM}	100	50 Hz Full Sine Wave, 1 cycle Non-repetitive	A
Operating Junction Temperature Range	T_{jw}	- 40 to + 150		$^{\circ}C$
Storage Temperature Range	T_{stg}	- 40 to + 150		$^{\circ}C$
Mounting torque		0.5	Recommended value	N•m

Electrical • Thermal Characteristics

Characteristics	Symbol	Conditions	Min.	Typ.	Max.	Unit
Peak Reverse Current	I_{RM}	$T_j=25^{\circ}C, V_{RM}=V_{RRM}$ per Diode	-	-	200	μA
Peak Forward Voltage	V_{FM}	$T_j=25^{\circ}C, I_{FM}=5A$ per Diode	-	-	0.90	V
Thermal Resistance	$R_{th(j-c)}$	Junction to Case	-	-	3	$^{\circ}C/W$
	$R_{th(c-f)}$	Case to Fin	-	-	1.5	

FCH_A_OUTLINE DRAWING (Dimensions in mm)

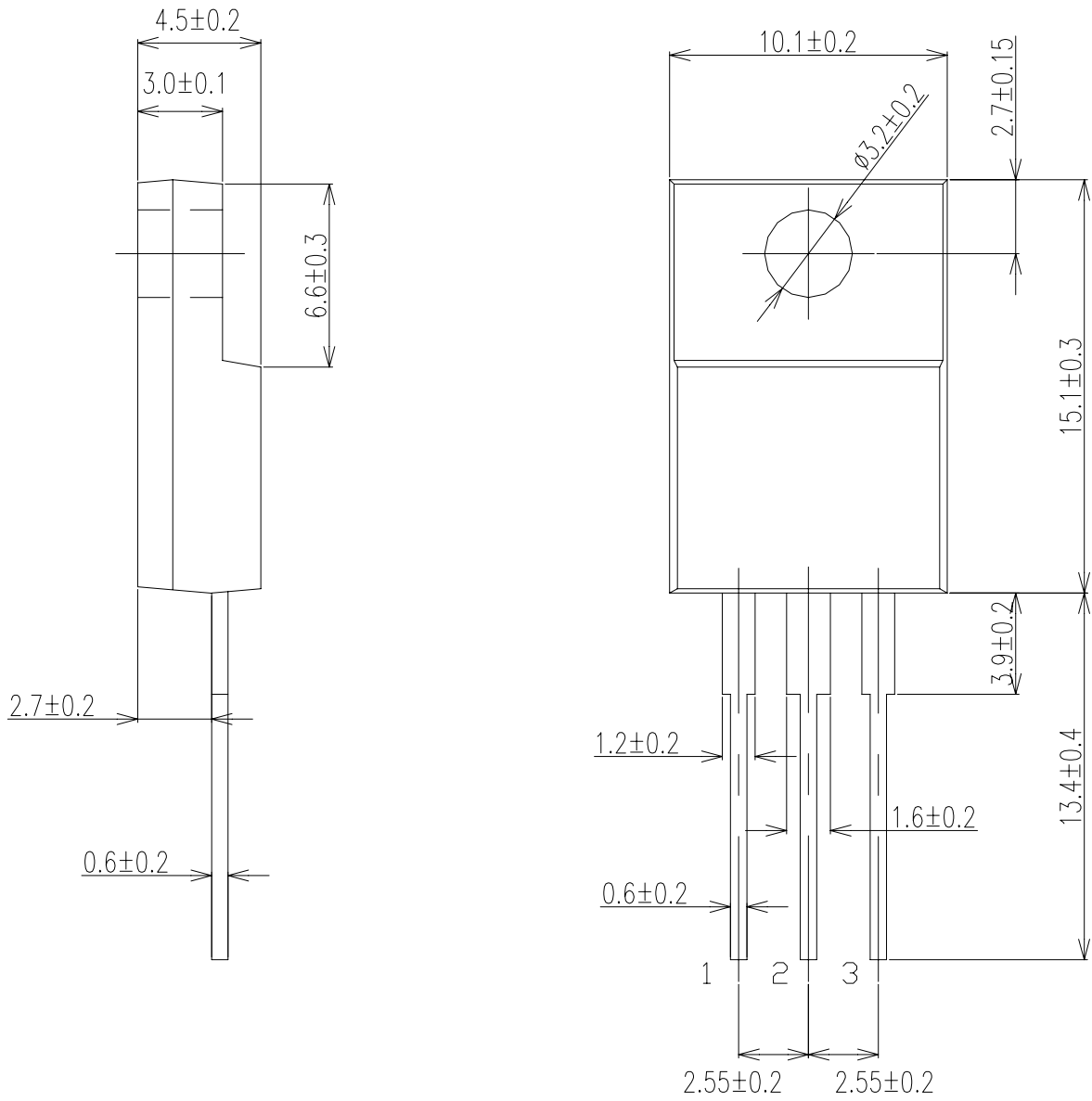

Center Tap

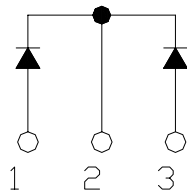

FORWARD CURRENT VS. VOLTAGE

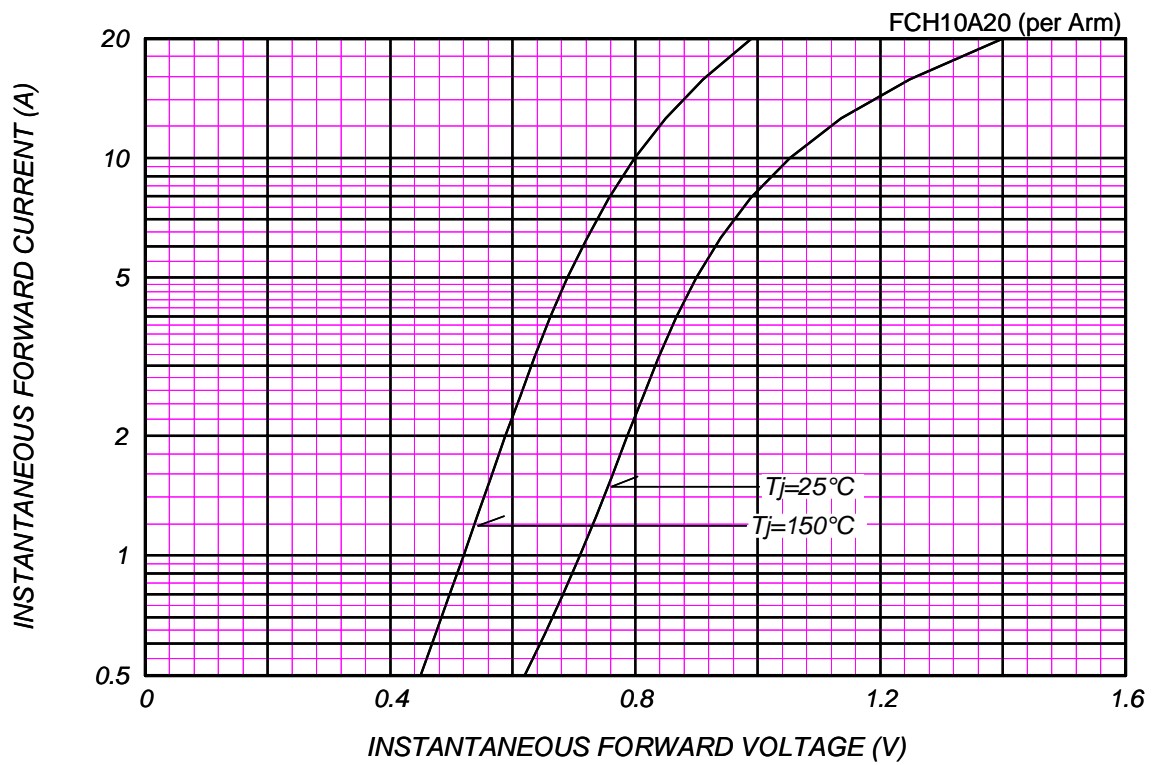

AVERAGE FORWARD POWER DISSIPATION

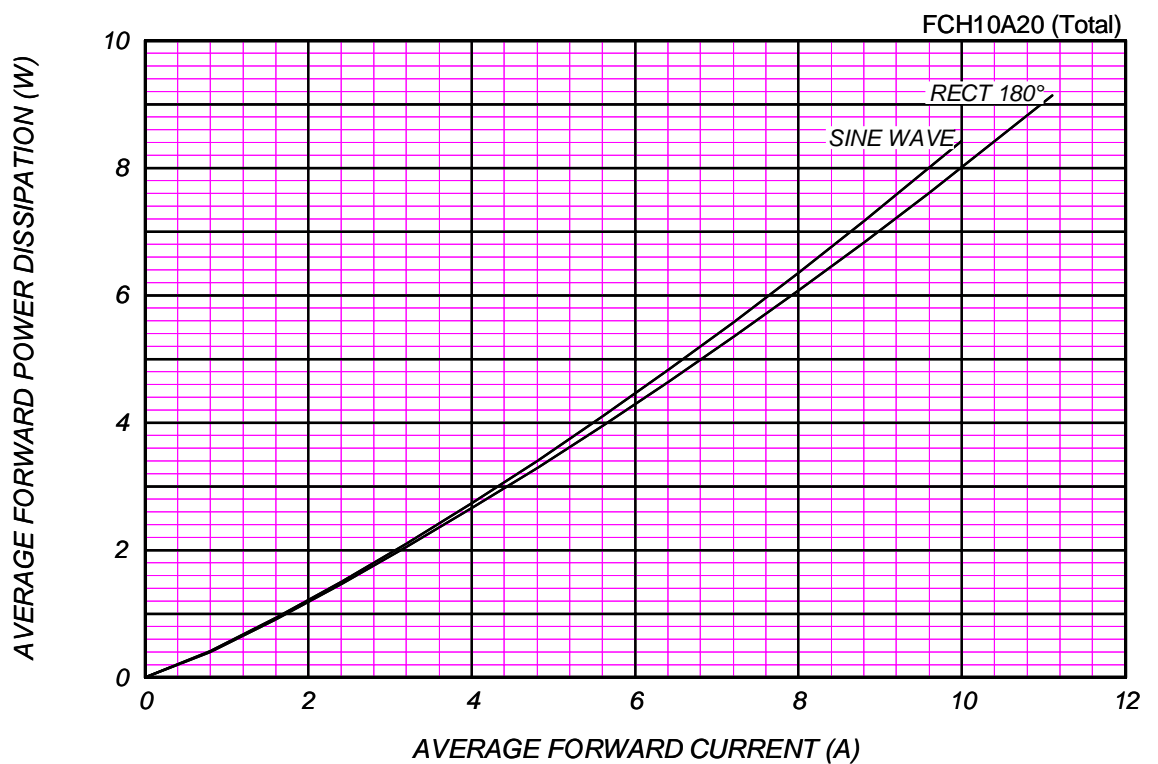

PEAK REVERSE CURRENT VS. PEAK REVERSE VOLTAGE

$T_j = 150\text{ }^\circ\text{C}$

FCH10A20 (per Arm)

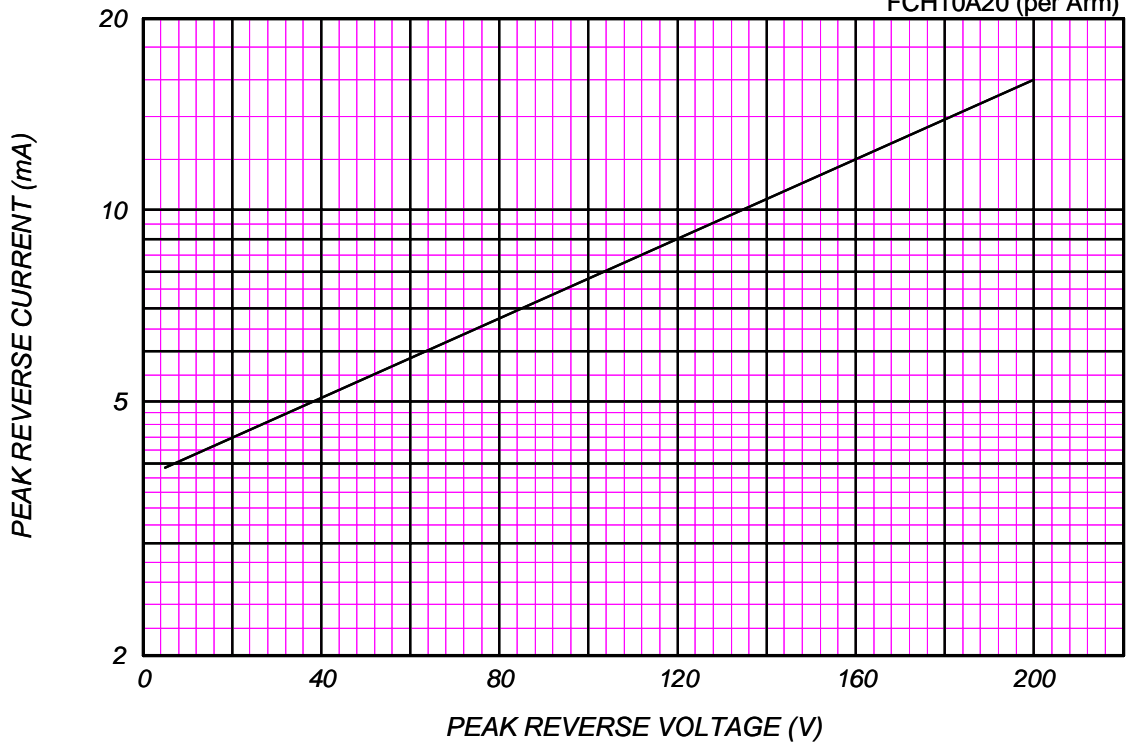

AVERAGE REVERSE POWER DISSIPATION

FCH10A20 (Total)

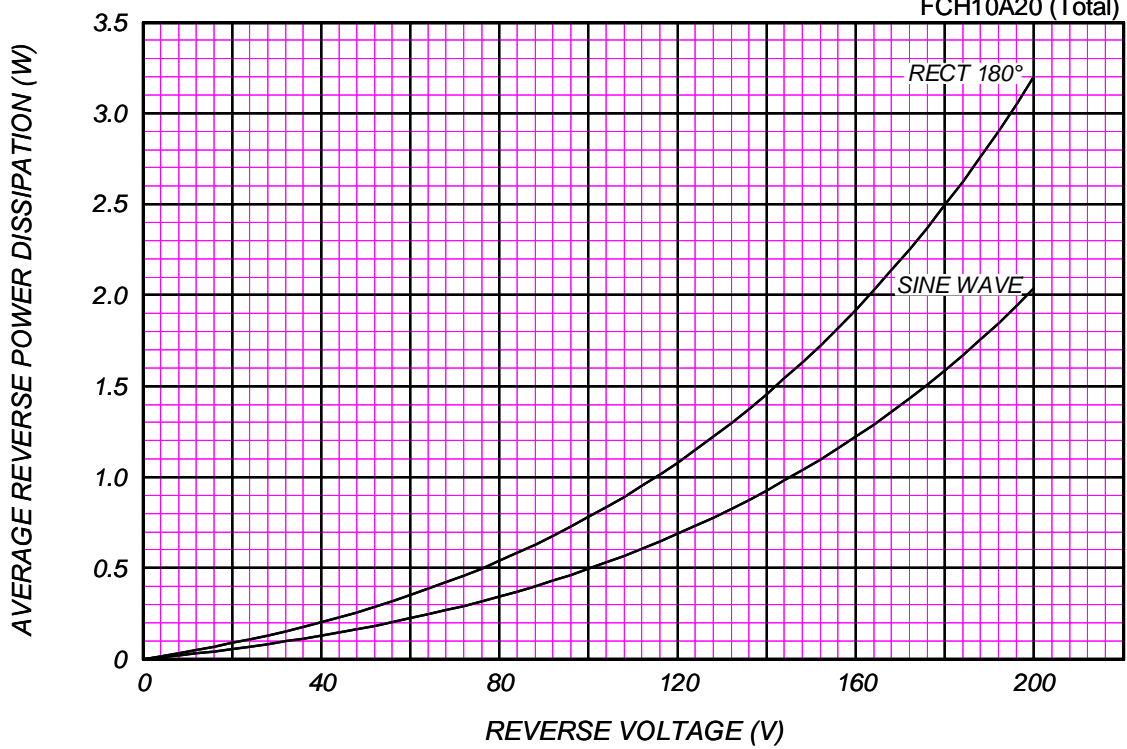

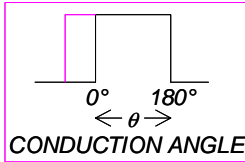

AVERAGE FORWARD CURRENT VS. CASE TEMPERATURE

$V_{RM}=200V$

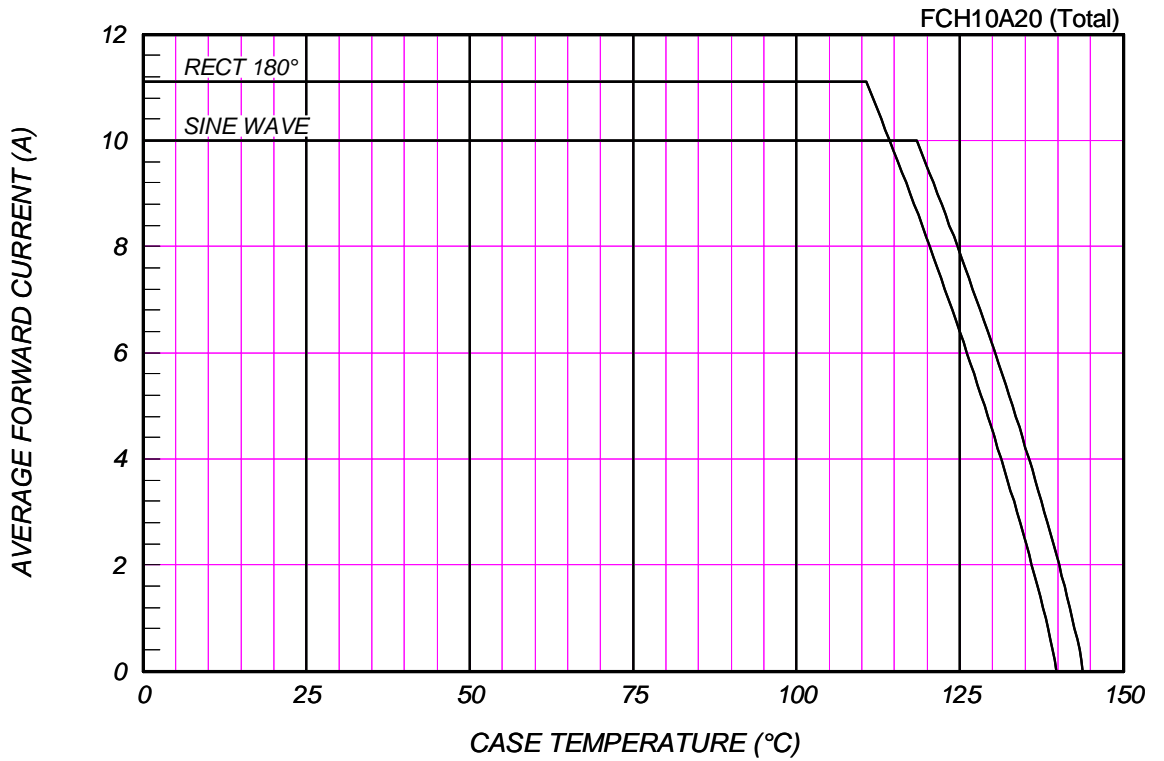

SURGE CURRENT RATINGS

f=50Hz, Half Sine Wave, Non-Repetitive, No Load

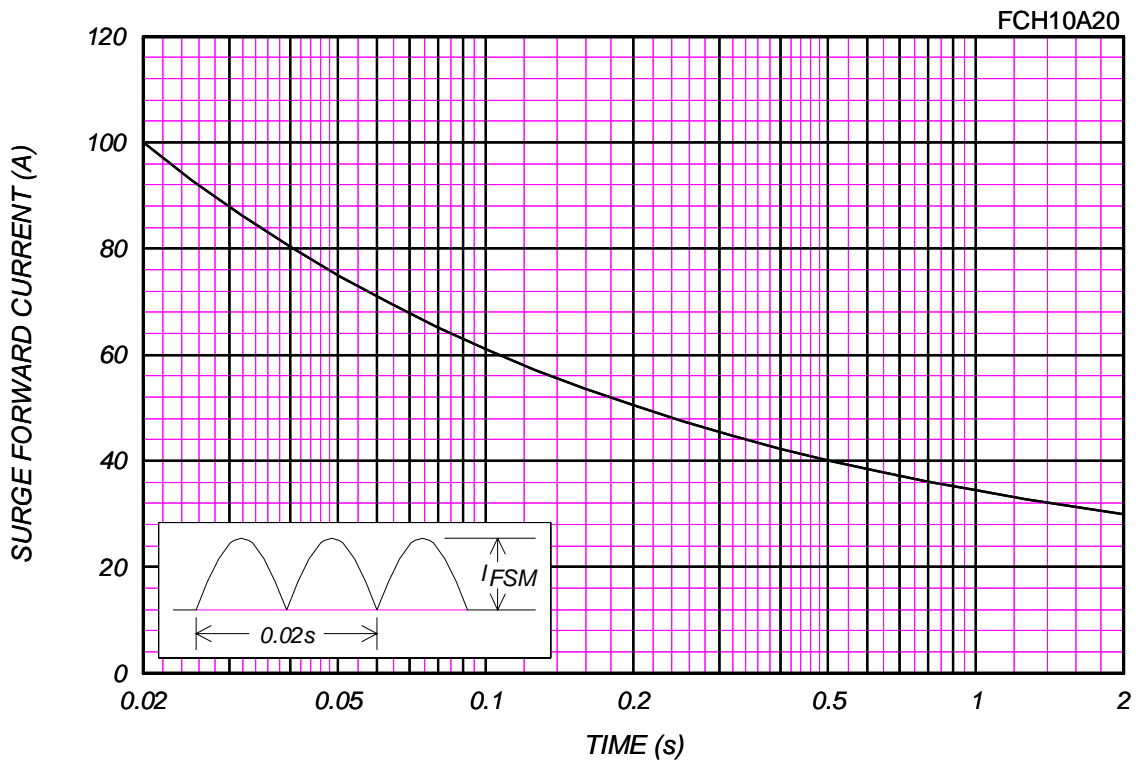

JUNCTION CAPACITANCE VS. REVERSE VOLTAGE

$T_j=25^{\circ}\text{C}$, $V_m=20mV_{\text{RMS}}$, $f=100\text{kHz}$, Typical Value

FCH10A20 (per Arm)

