

**Applications**

- High Frequency DC-DC Isolated Converters with Synchronous Rectification for Telecom and Industrial use
- High Frequency Buck Converters for Computer Processor Power

HEXFET® Power MOSFET

<b>V<sub>DSS</sub></b>	<b>R<sub>DS(on)</sub> max</b>	<b>I<sub>D</sub></b>
<b>30V</b>	<b>12.5mΩ</b>	<b>62A</b>

**Benefits**

- Ultra-Low Gate Impedance
- Very Low R<sub>DS(on)</sub>
- Fully Characterized Avalanche Voltage and Current

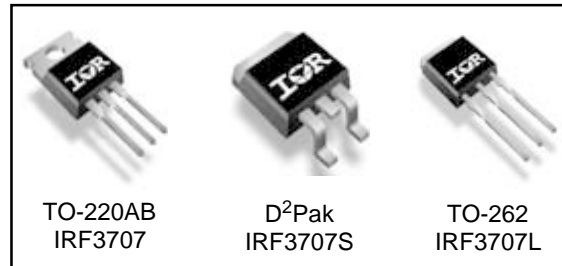

**Absolute Maximum Ratings**

Symbol	Parameter	Max.	Units
V <sub>DS</sub>	Drain-Source Voltage	30	V
V <sub>GS</sub>	Gate-to-Source Voltage	± 20	V
I <sub>D</sub> @ T <sub>C</sub> = 25°C	Continuous Drain Current, V <sub>GS</sub> @ 10V	62	A
I <sub>D</sub> @ T <sub>C</sub> = 70°C	Continuous Drain Current, V <sub>GS</sub> @ 10V	52	
I <sub>DM</sub>	Pulsed Drain Current <sup>①</sup>	248	
P <sub>D</sub> @ T <sub>C</sub> = 25°C	Maximum Power Dissipation <sup>③</sup>	87	W
P <sub>D</sub> @ T <sub>C</sub> = 70°C	Maximum Power Dissipation <sup>③</sup>	61	W
	Linear Derating Factor	0.59	mW/°C
T <sub>J</sub> , T <sub>STG</sub>	Junction and Storage Temperature Range	-55 to + 175	°C

**Thermal Resistance**

	Parameter	Typ.	Max.	Units
R <sub>θJC</sub>	Junction-to-Case	—	1.73	°C/W
R <sub>θCS</sub>	Case-to-Sink, Flat, Greased Surface <sup>④</sup>	0.50	—	
R <sub>θJA</sub>	Junction-to-Ambient <sup>④</sup>	—	62	
R <sub>θJA</sub>	Junction-to-Ambient (PCB mount)*	—	40	

\* When mounted on 1" square PCB (FR-4 or G-10 Material) .  
 For recommended footprint and soldering techniques refer to application note #AN-994

Notes ① through ④ are on page 10

www.irf.com

## Static @ T<sub>J</sub> = 25°C (unless otherwise specified)

	Parameter	Min.	Typ.	Max.	Units	Conditions
V <sub>(BR)DSS</sub>	Drain-to-Source Breakdown Voltage	30	—	—	V	V <sub>GS</sub> = 0V, I <sub>D</sub> = 250μA
ΔV <sub>(BR)DSS</sub> /ΔT <sub>J</sub>	Breakdown Voltage Temp. Coefficient	—	0.027	—	V/°C	Reference to 25°C, I <sub>D</sub> = 1mA
R <sub>DS(on)</sub>	Static Drain-to-Source On-Resistance	—	9.0	12.5	mΩ	V <sub>GS</sub> = 10V, I <sub>D</sub> = 15A ③
		—	12.6	17		V <sub>GS</sub> = 4.5V, I <sub>D</sub> = 12A ③
V <sub>GS(th)</sub>	Gate Threshold Voltage	1.0	—	3.0	V	V <sub>DS</sub> = V <sub>GS</sub> , I <sub>D</sub> = 250μA
I <sub>DSS</sub>	Drain-to-Source Leakage Current	—	—	20	μA	V <sub>DS</sub> = 24V, V <sub>GS</sub> = 0V
		—	—	100		V <sub>DS</sub> = 24V, V <sub>GS</sub> = 0V, T <sub>J</sub> = 125°C
I <sub>GSS</sub>	Gate-to-Source Forward Leakage	—	—	200	nA	V <sub>GS</sub> = 16V
	Gate-to-Source Reverse Leakage	—	—	-200		V <sub>GS</sub> = -16V

## Dynamic @ T<sub>J</sub> = 25°C (unless otherwise specified)

Symbol	Parameter	Min.	Typ.	Max.	Units	Conditions
g <sub>fs</sub>	Forward Transconductance	37	—	—	S	V <sub>DS</sub> = 15V, I <sub>D</sub> = 49.6A
Q <sub>g</sub>	Total Gate Charge	—	19	—	nC	I <sub>D</sub> = 24.8A
Q <sub>gs</sub>	Gate-to-Source Charge	—	8.2	—		V <sub>DS</sub> = 15V
Q <sub>gd</sub>	Gate-to-Drain ("Miller") Charge	—	6.3	—		V <sub>GS</sub> = 4.5V ③
Q <sub>oss</sub>	Output Gate Charge	—	18	27		V <sub>GS</sub> = 0V, V <sub>DS</sub> = 15V
t <sub>d(on)</sub>	Turn-On Delay Time	—	8.5	—	ns	V <sub>DD</sub> = 15V
t <sub>r</sub>	Rise Time	—	78	—		I <sub>D</sub> = 24.8A
t <sub>d(off)</sub>	Turn-Off Delay Time	—	11.8	—		R <sub>G</sub> = 1.8Ω
t <sub>f</sub>	Fall Time	—	3.3	—		V <sub>GS</sub> = 4.5V ③
C <sub>iss</sub>	Input Capacitance	—	1990	—	pF	V <sub>GS</sub> = 0V
C <sub>oss</sub>	Output Capacitance	—	707	—		V <sub>DS</sub> = 15V
C <sub>rss</sub>	Reverse Transfer Capacitance	—	50	—		f = 1.0MHz

## Avalanche Characteristics

Symbol	Parameter	Typ.	Max.	Units
E <sub>AS</sub>	Single Pulse Avalanche Energy②	—	213	mJ
I <sub>AR</sub>	Avalanche Current①	—	62	A

## Diode Characteristics

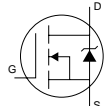
Symbol	Parameter	Min.	Typ.	Max.	Units	Conditions
I <sub>S</sub>	Continuous Source Current (Body Diode)	—	—	62	A	MOSFET symbol showing the integral reverse p-n junction diode. 
I <sub>SM</sub>	Pulsed Source Current (Body Diode) ①	—	—	248		
V <sub>SD</sub>	Diode Forward Voltage	—	0.88	1.3	V	T <sub>J</sub> = 25°C, I <sub>S</sub> = 31A, V <sub>GS</sub> = 0V ③
		—	0.8	—		T <sub>J</sub> = 125°C, I <sub>S</sub> = 31A, V <sub>GS</sub> = 0V ③
t <sub>rr</sub>	Reverse Recovery Time	—	39	59	ns	T <sub>J</sub> = 25°C, I <sub>F</sub> = 31A, V <sub>R</sub> = 20V
Q <sub>rr</sub>	Reverse Recovery Charge	—	49	74	nC	di/dt = 100A/μs ③
t <sub>rr</sub>	Reverse Recovery Time	—	42	63	ns	T <sub>J</sub> = 125°C, I <sub>F</sub> = 31A, V <sub>R</sub> = 20V
Q <sub>rr</sub>	Reverse Recovery Charge	—	62	93	nC	di/dt = 100A/μs ③

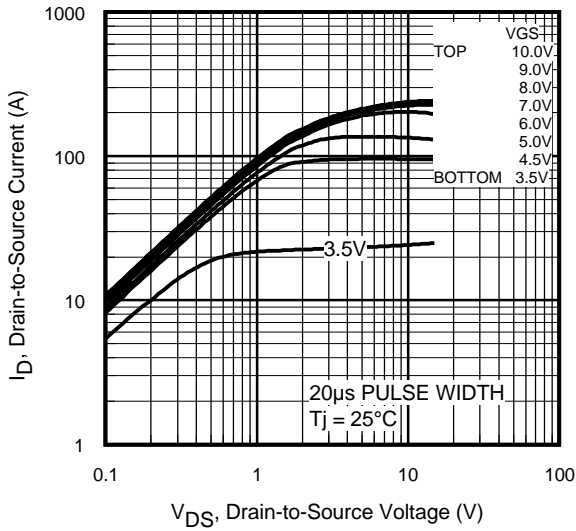

**Fig 1.** Typical Output Characteristics

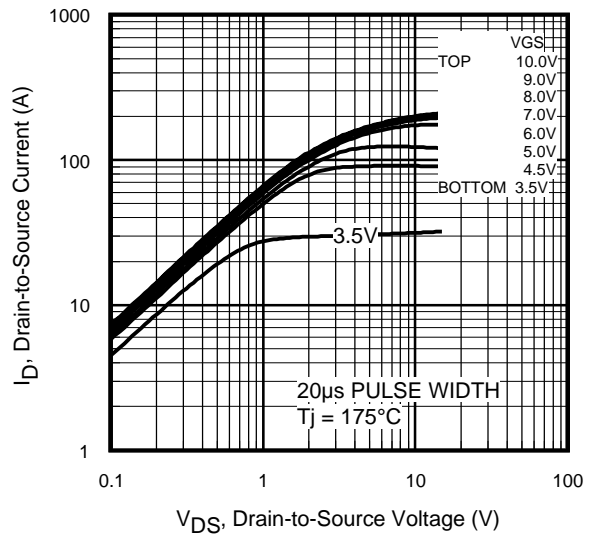

**Fig 2.** Typical Output Characteristics

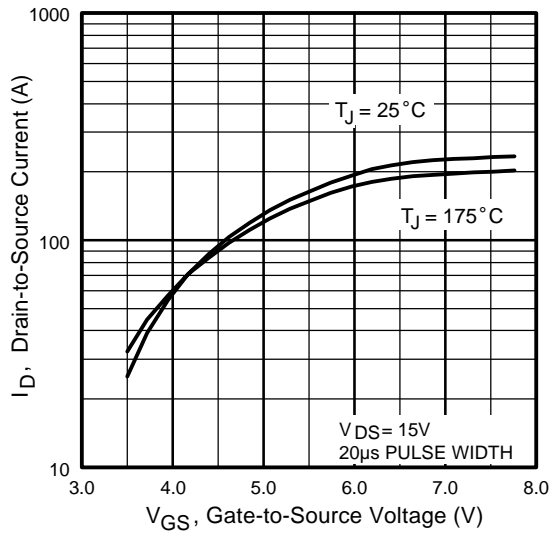

**Fig 3.** Typical Transfer Characteristics

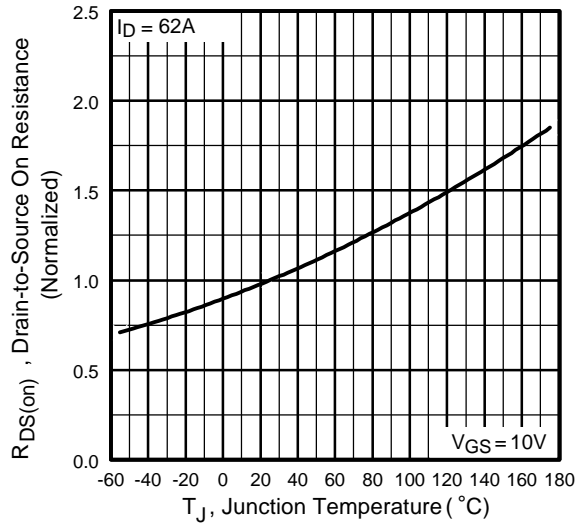

**Fig 4.** Normalized On-Resistance Vs. Temperature

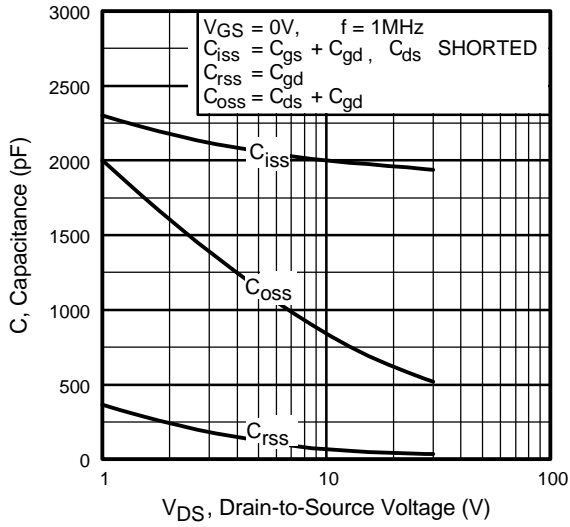

**Fig 5.** Typical Capacitance Vs. Drain-to-Source Voltage

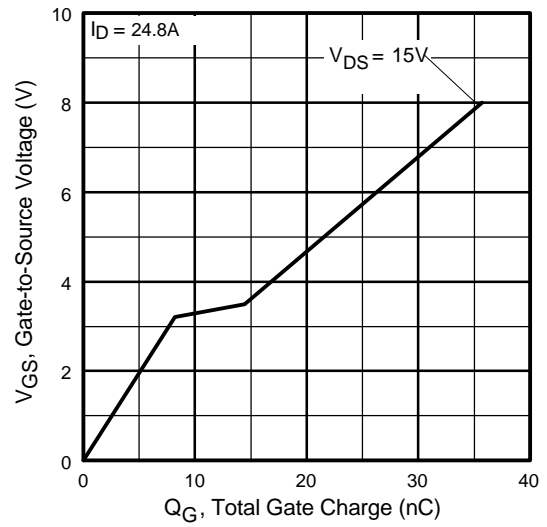

**Fig 6.** Typical Gate Charge Vs. Gate-to-Source Voltage

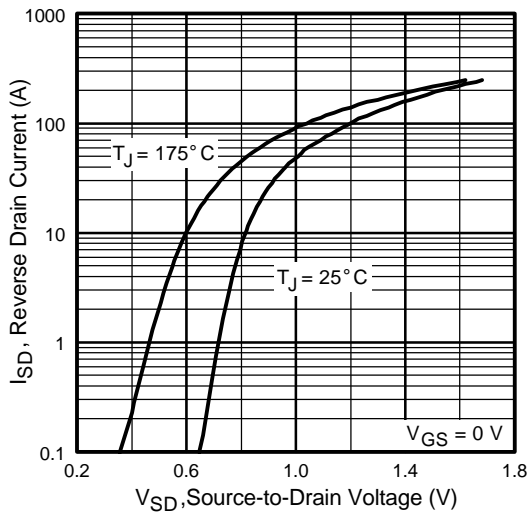

**Fig 7.** Typical Source-Drain Diode Forward Voltage

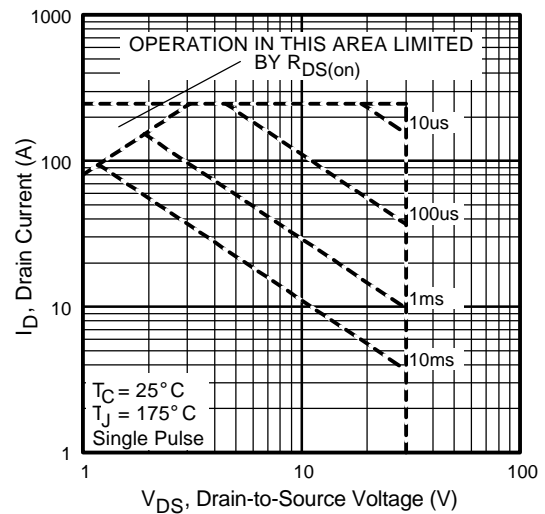

**Fig 8.** Maximum Safe Operating Area

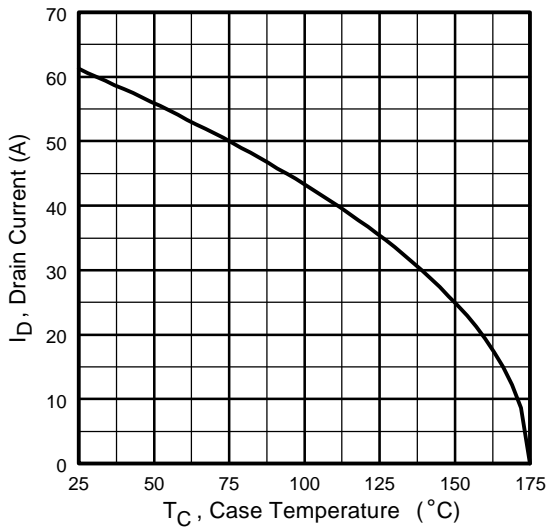

**Fig 9.** Maximum Drain Current Vs. Case Temperature

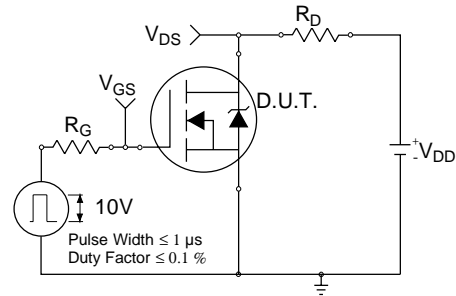

**Fig 10a.** Switching Time Test Circuit

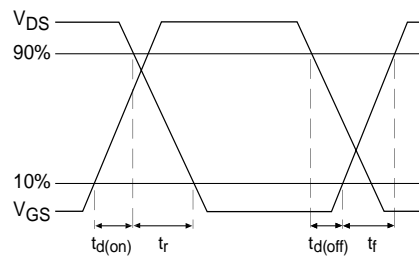

**Fig 10b.** Switching Time Waveforms

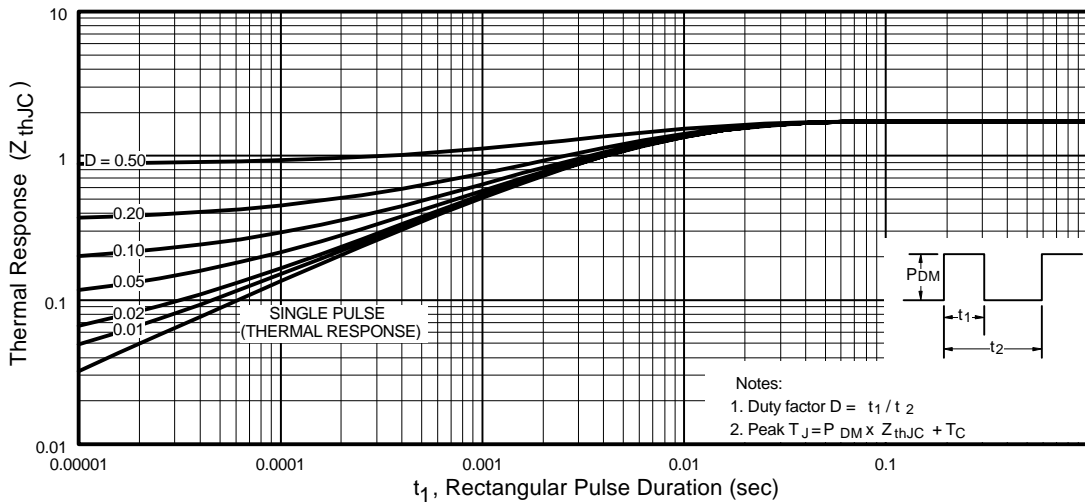

**Fig 11.** Maximum Effective Transient Thermal Impedance, Junction-to-Ambient

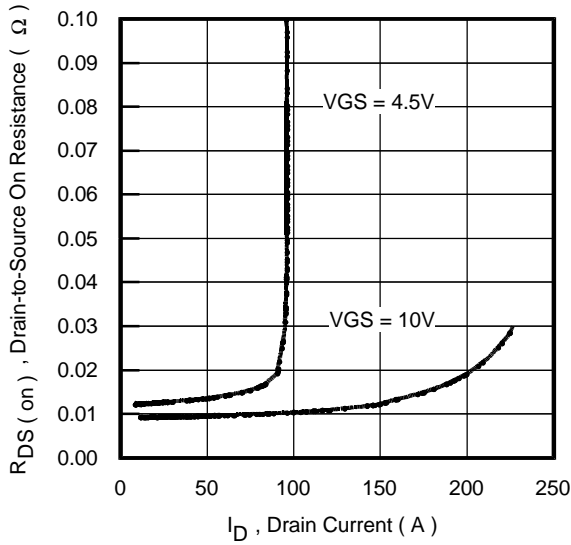

**Fig 12.** On-Resistance Vs. Drain Current

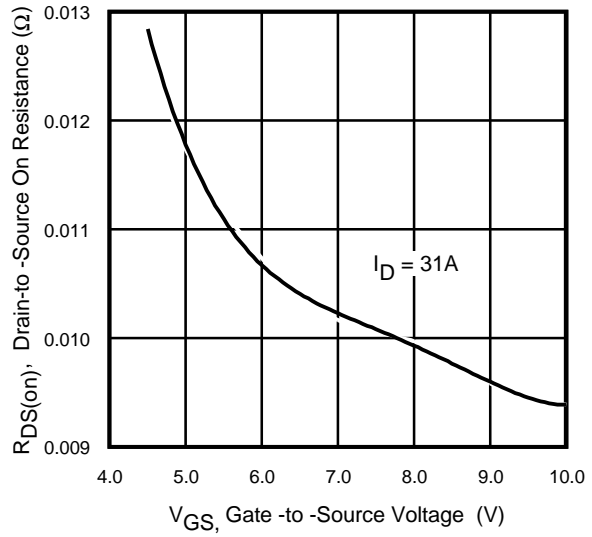

**Fig 13.** On-Resistance Vs. Gate Voltage

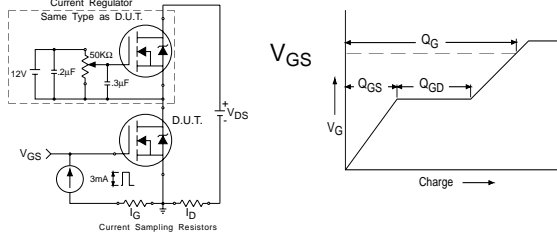

**Fig 14a&b.** Basic Gate Charge Test circuit and Waveforms

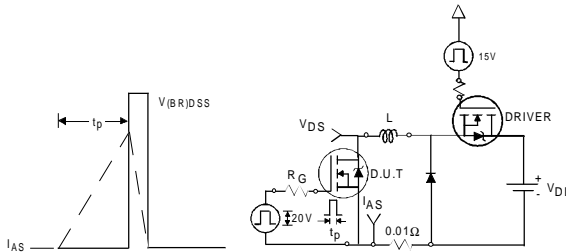

**Fig 15a&b.** Unclamped Inductive Test circuit and Waveforms

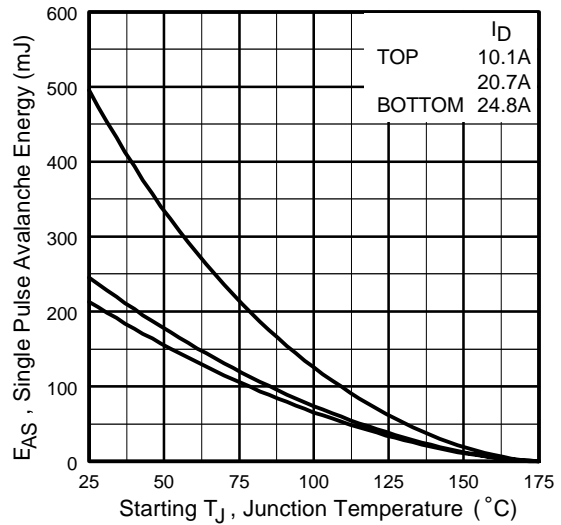

**Fig 15c.** Maximum Avalanche Energy Vs. Drain Current

## TO-220AB Package Outline

Dimensions are shown in millimeters (inches)

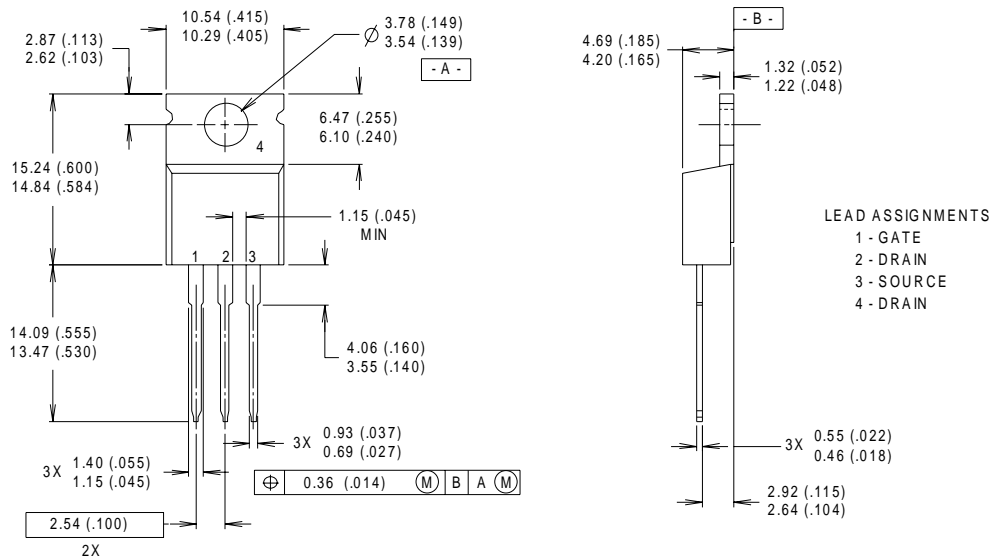

**NOTES:**

- 1 DIMENSIONING & TOLERANCING PER ANSI Y14.5M, 1982.
- 2 CONTROLLING DIMENSION : INCH
- 3 OUTLINE CONFORMS TO JEDEC OUTLINE TO-220AB.
- 4 HEATSINK & LEAD MEASUREMENTS DO NOT INCLUDE BURRS.

## TO-220AB Part Marking Information

EXAMPLE : THIS IS AN IRF1010  
 WITH ASSEMBLY  
 LOT CODE 9B1M

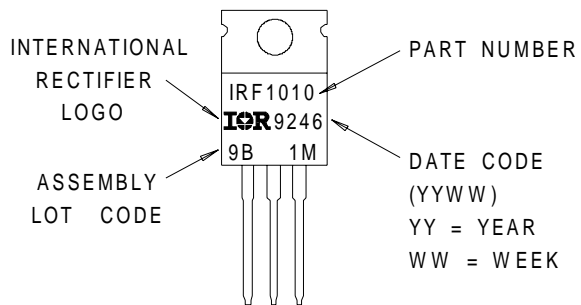

# IRF3707/3707S/3707L

International  
**IR** Rectifier

## D<sup>2</sup>Pak Package Outline

Dimensions are shown in millimeters (inches)

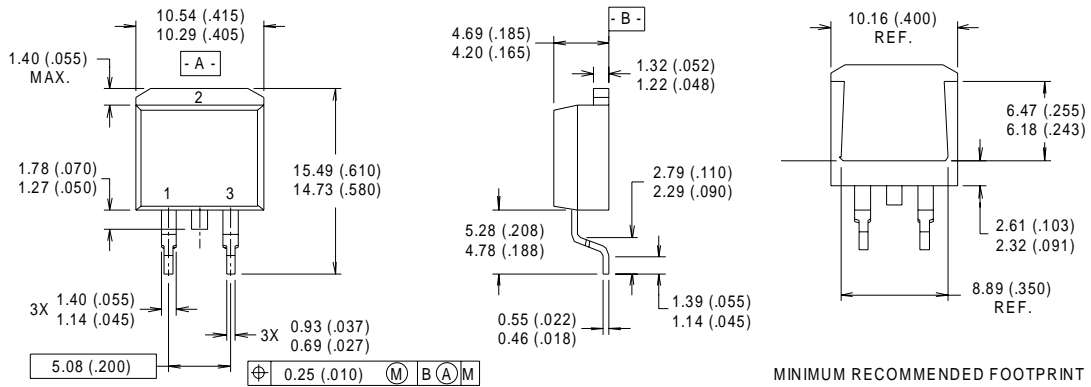

### NOTES:

- 1 DIMENSIONS AFTER SOLDER DIP.
- 2 DIMENSIONING & TOLERANCING PER ANSI Y14.5M, 1982.
- 3 CONTROLLING DIMENSION : INCH.
- 4 HEATSINK & LEAD DIMENSIONS DO NOT INCLUDE BURRS.

### LEAD ASSIGNMENTS

- 1 - GATE
- 2 - DRAIN
- 3 - SOURCE

### MINIMUM RECOMMENDED FOOTPRINT

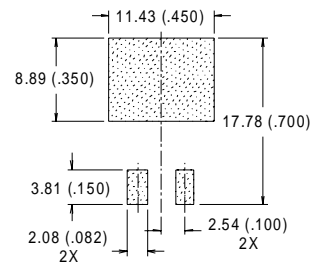

## D<sup>2</sup>Pak Part Marking Information

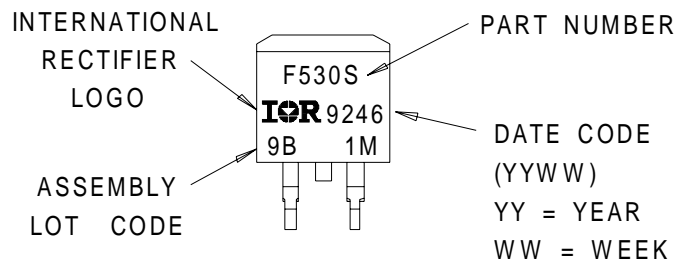



## TO-262 Package Outline

Dimensions are shown in millimeters (inches)

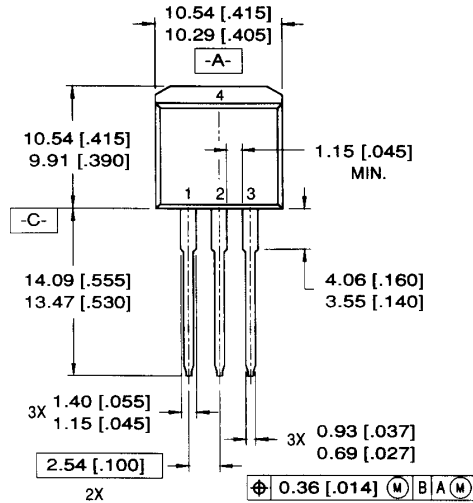

**LEAD ASSIGNMENTS**

- 1 = GATE      3 = SOURCE
- 2 = DRAIN    4 = DRAIN

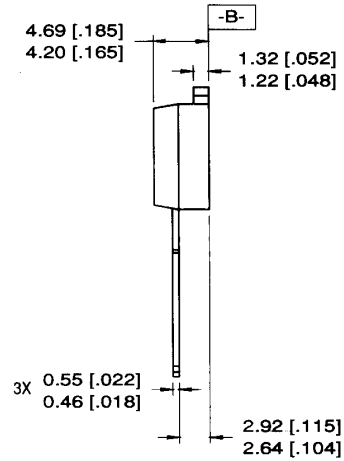

**NOTES:**

1. DIMENSIONING & TOLERANCING PER ANSI Y14.5M-1982
2. CONTROLLING DIMENSION: INCH.
3. DIMENSIONS ARE SHOWN IN MILLIMETERS [INCHES].
4. HEATSINK & LEAD DIMENSIONS DO NOT INCLUDE BURRS.

## TO-262 Part Marking Information

EXAMPLE: THIS IS AN IRL3103L  
 LOT CODE 1789  
 ASSEMBLED ON WW 19, 1997  
 IN THE ASSEMBLY LINE "C"

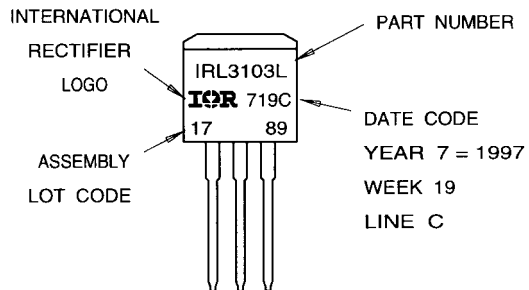

# IRF3707/3707S/3707L

International  
**IR** Rectifier

## D<sup>2</sup>Pak Tape & Reel Information

Dimensions are shown in millimeters (inches)

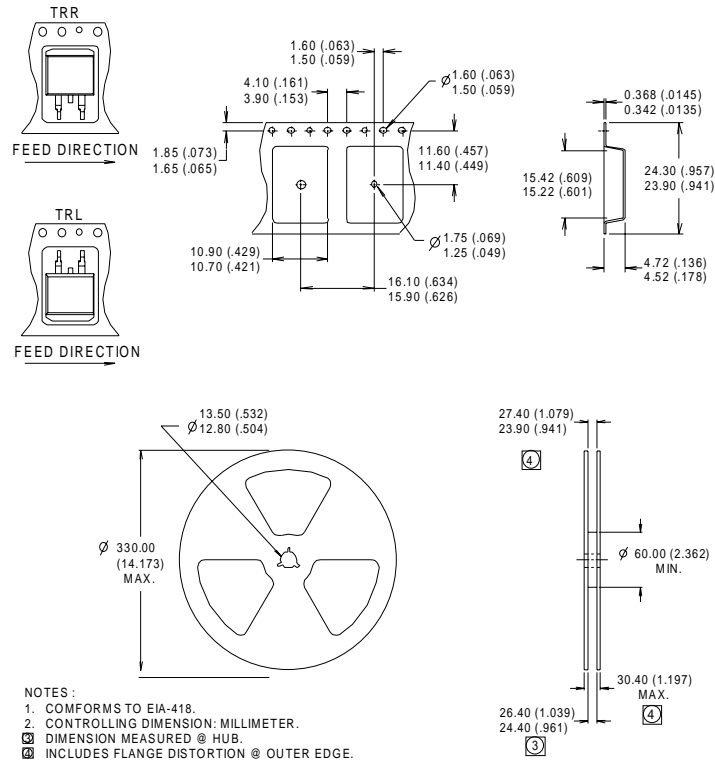

### Notes:

- ① Repetitive rating; pulse width limited by max. junction temperature.
- ② Starting  $T_J = 25^\circ\text{C}$ ,  $L = 0.7$  mH  
 $R_G = 25\Omega$ ,  $I_{AS} = 24.8$  A.
- ③ Pulse width  $\leq 300\mu\text{s}$ ; duty cycle  $\leq 2\%$ .
- ④ This is only applied to TO-220AB package

International  
**IR** Rectifier

**IR WORLD HEADQUARTERS:** 233 Kansas St., El Segundo, California 90245, USA Tel: (310) 252-7105

**IR EUROPEAN REGIONAL CENTRE:** 439/445 Godstone Rd, Whyteleafe, Surrey CR3 OBL, UK Tel: ++ 44 (0)20 8645 8000

**IR CANADA:** 15 Lincoln Court, Brampton, Ontario L6T3Z2, Tel: (905) 453 2200

**IR GERMANY:** Saalburgstrasse 157, 61350 Bad Homburg Tel: ++ 49 (0) 6172 96590

**IR ITALY:** Via Liguria 49, 10071 Borgaro, Torino Tel: ++ 39 011 451 0111

**IR JAPAN:** K&H Bldg., 2F, 30-4 Nishi-Ikebukuro 3-Chome, Toshima-Ku, Tokyo 171 Tel: 81 (0)3 3983 0086

**IR SOUTHEAST ASIA:** 1 Kim Seng Promenade, Great World City West Tower, 13-11, Singapore 237994 Tel: ++ 65 (0)838 4630

**IR TAIWAN:** 16 Fl. Suite D. 207, Sec. 2, Tun Haw South Road, Taipei, 10673 Tel: 886-(0)2 2377 9936

*Data and specifications subject to change without notice. 8/00*

Note: For the most current drawings please refer to the IR website at:  
<http://www.irf.com/package/>