

Switching (30V, 9A)

RSS090N03

●Features

- 1) Low on-resistance.
- 2) Built-in G-S Protection Diode.
- 3) Small and Surface Mount Package (SOP8).

●Application

Power switching, DC/DC converter.

●Structure

Silicon N-channel
MOS FET

●External dimensions (Units : mm)

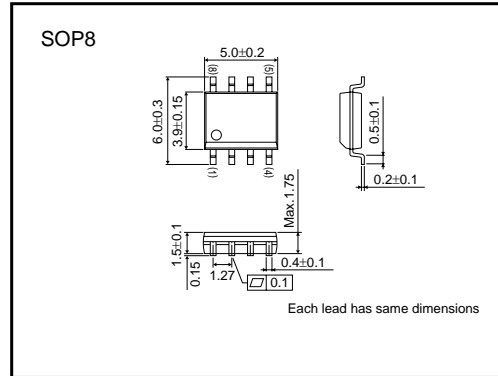

●Absolute maximum ratings (Ta = 25°C)

Parameter	Symbol	Limits	Unit
Drain-Source Voltage	V _{DSS}	30	V
Gate-Source Voltage	V _{GSS}	20	V
Drain Current	Continuous	I _D	±9.0 A
	Pulsed	I _{DP} *	±36 A
Source Current (Body Diode)	Continuous	I _S	1.6 A
	Pulsed	I _{SP} *	6.4 A
Total Power Dissipation (TC=25°C)	P _D	2	W
Channel Temperature	T _{ch}	150	°C
Storage Temperature	T _{stg}	-55 to +150	°C

*Pw≤10μs, Duty cycle≤1%

●Equivalent circuit

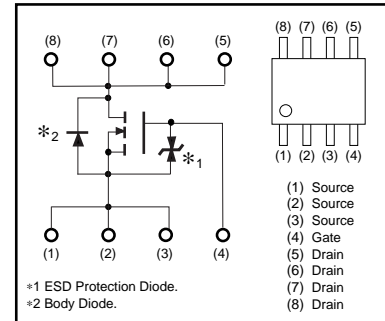

*1 ESD Protection Diode.
*2 Body Diode.
* A protection diode is included between the gate and the source terminals to protect the diode against static electricity when the product is in use. Use a protection circuit when the fixed voltage are exceeded.

●Thermal resistance (Ta = 25°C)

Parameter	Symbol	Limits	Unit
Channel to Ambient	R _{th} (ch-A)	62.5	°C / W

Transistors

●Electrical characteristics (Ta = 25°C)

Parameter	Symbol	Min.	Typ.	Max.	Unit	Test Conditions
Gate-Source Leakage	I _{GSS}	–	–	10	μA	V _{GS} =20V, V _{DS} =0V
Drain-Source Breakdown Voltage	V _{(BR)DSS}	30	–	–	V	I _D =1mA, V _{GS} =0V
Zero Gate Voltage Drain Current	I _{DSS}	–	–	1	μA	V _{DS} =30V, V _{GS} =0V
Gate Threshold Voltage	V _{GS(th)}	1.0	–	2.5	V	V _{DS} =10V, I _D =1mA
Static Drain-Source On-State Resistance	R _{DS(on)} *	–	11	15	mΩ	I _D =9A, V _{GS} =10V
		–	15	22		I _D =9A, V _{GS} =4.5V
		–	17	24		I _D =9A, V _{GS} =4V
Forward Transfer Admittance	Y _{fs} *	6.0	–	–	S	I _D =9A, V _{DS} =10V
Input Capacitance	C _{iss}	–	810	–	pF	V _{DS} =10V
Output Capacitance	C _{oss}	–	225	–	pF	V _{GS} =0V
Reverse Transfer Capacitance	C _{rss}	–	160	–	pF	f=1MHz
Turn-On Delay Time	t _{d(on)} *	–	10	–	ns	I _D =4.5A, V _{DD} =15V
Rise Time	t _r *	–	13	–	ns	V _{GS} =10V
Turn-Off Delay Time	t _{d(off)} *	–	46	–	ns	R _L =3.33Ω
Fall Time	t _f *	–	15	–	ns	R _{GS} =10Ω
Total Gate Charge	Q _g *	–	11	15	nC	V _{DD} =15V
Gate-Source Charge	Q _{gs} *	–	2.5	–	nC	V _{GS} =5V
Gate-Drain Charge	Q _{gd} *	–	4.5	–	nC	I _D =9A

*Pulsed

●Body diode characteristics (Source-Drain Characteristics) (Ta = 25°C)

Parameter	Symbol	Min.	Typ.	Max.	Unit	Test Conditions
Forward Voltage	V _{SD} *	–	–	1.2	V	I _S =6.4A, V _{GS} =0V

*Pulsed

Transistors

●Electrical characteristic curves

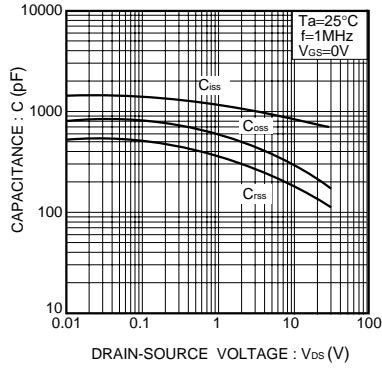

Fig.1 Typical Capacitance vs. Drain-Source Voltage

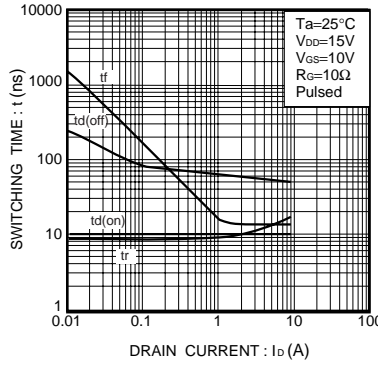

Fig.2 Switching Characteristics

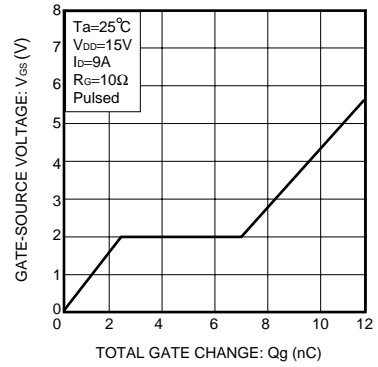

Fig.3 Dynamic Input Characteristics

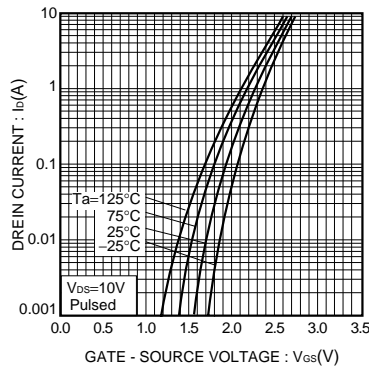

Fig.4 Typical Transfer Characteristics

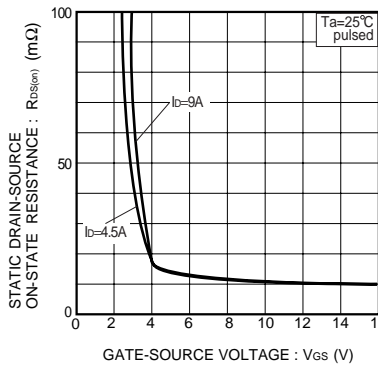

Fig.5 Static Drain-Source On-State Resistance vs. Gate-Source Voltage

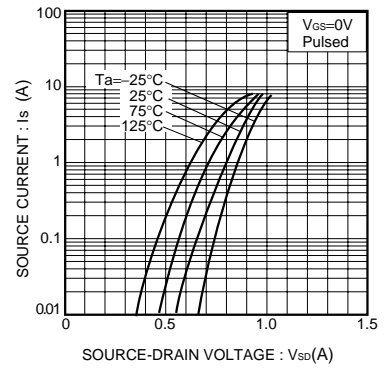

Fig.6 Source-Current vs. Source-Drain Voltage

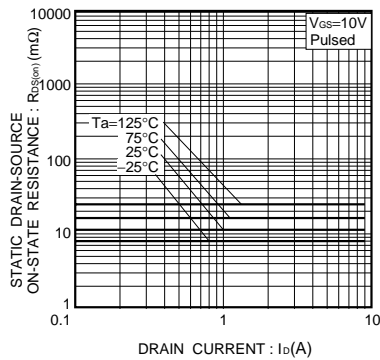

Fig.7 Static Drain-Source On-State Resistance vs. Drain Current (1)

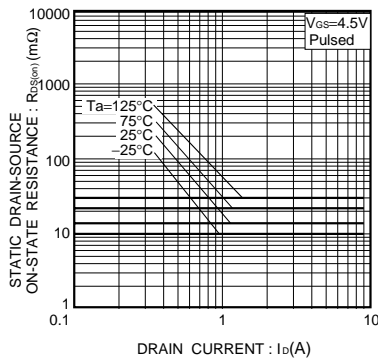

Fig.8 Static Drain-Source On-State Resistance vs. Drain Current (2)

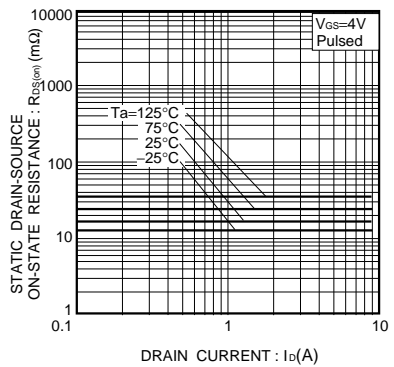

Fig.9 Static Drain-Source On-State Resistance vs. Drain Current (3)

This datasheet has been download from:

www.datasheetcatalog.com

Datasheets for electronics components.