

LOW VOLTAGE AUDIO POWER AMPLIFIER

■ GENERAL DESCRIPTION

The NJM386 is a power amplifier designed for use in low voltage consumer applications. The gain is internally set to 20 to keep external part count low, but the addition of an external resistor and capacitor between pins 1 and 8 will increase the gain to any value up to 200.

The inputs are ground reference while the output is automatically biased to one half the supply voltage. The quiescent power drain is only 24 milliwatts when operating from a 6 volt supply, making the NJM386 ideal for battery operation.

■ PACKAGE OUTLINE

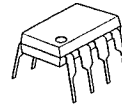

NJM386D



NJM386M

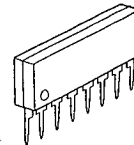

NJM386L

■ FEATURES

- Operating Voltage (4V~12V)
- Minimum External Components
- Low Operating Current (3mA)
- Voltage Gain (20~200)
- Single Supply Operation
- Self-centering of Output Offset Voltage
- Package Outline DIP8, SIP8, DMP8
- Bipolar Technology

■ APPLICATIONS

- AM-FM radio amplifiers
- Portable tape player amplifiers
- Intercoms
- TV sound systems
- Line drivers
- Ultrasonic drivers
- Small servo drivers
- Power converters

■ PIN CONFIGURATION

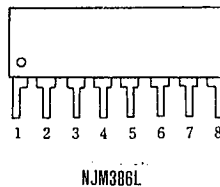
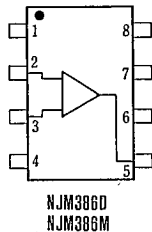

PIN CONNECTION:

1. GAIN
2. -INPUT
3. +INPUT
4. GND
5. OUTPUT
6. V+
7. BYPASS
8. GAIN

■ EQUIVALENT CIRCUIT

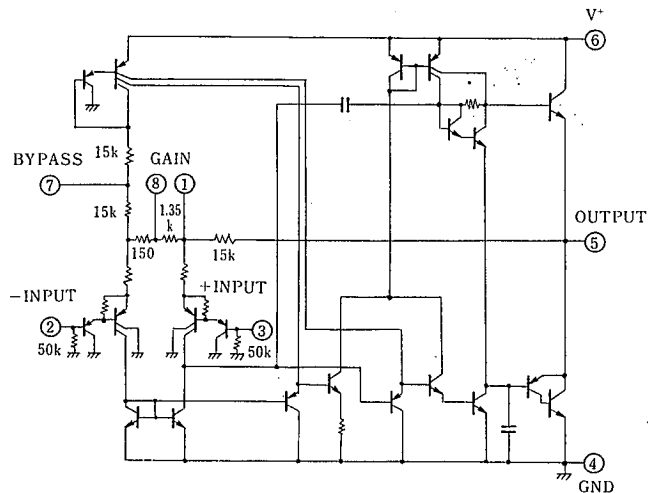

■ ABSOLUTE MAXIMUM RATINGS

($t_a=25^\circ\text{C}$)

PARAMETER	SYMBOL	RATINGS	UNIT
Supply Voltage	V^+	15	V
Power Dissipation	P_D	(DIP8) 700	mW
		(SIP8) 800	mW
		(DMP8) 300	mW
Input Voltage Range	V_{IN}	± 0.4	V
Operating Temperature Range	T_{opr}	$-40 \sim +85$	$^\circ\text{C}$
Storage Temperature Range	T_{stg}	$-40 \sim +125$	$^\circ\text{C}$

■ ELECTRICAL CHARACTERISTICS

($T_a=25^\circ\text{C}$)

PARAMETER	SYMBOL	TEST CONDITION	MIN.	TYP.	MAX.	UNIT
Operating Voltage	V^+		4	—	12	V
Operating Current	I_{CC}	$V^+=6\text{V}, V_{IN}=0$	—	3	8	mA
Output Power (note 2)	P_o	$V^+=6\text{V}, R_L=8\Omega, \text{THD}=10\%$	250	325	—	mW
		$V^+=9\text{V}, R_L=16\Omega, \text{THD}=10\%$	—	500	—	mW
Voltage Gain	A_V	$V^+=6\text{f}, f=1\text{kHz}$	24	26	28	dB
		$10\mu\text{F}$ from Pin 1 to 8	43	46	49	dB
Bandwidth	BW	$V^+=6\text{V}, \text{Pins 1 and 8 Open}$	—	300	—	kHz
Total Harmonic Distortion	THD	$V^+=6\text{V}, R_L=8\Omega, P_{OUT}=125\text{mW}$	—	0.2	—	%
		$f=1\text{kHz}, \text{Pins 1 and 8 open}$	—	—	—	—
Power Supply Rejection Ratio	SVR	$V^+=6\text{V}, f=1\text{kHz}, C_{BYPASS}=10\mu\text{F}$ Pins 1 and 8 Open	—	50	—	dB
Input Resistance	R_{IN}		—	50	—	k Ω
Input Bias Current	I_B	$V^+=6\text{V}, \text{Pins 2 and 3 Open}$	—	250	—	nA

■ TYPICAL APPLICATION

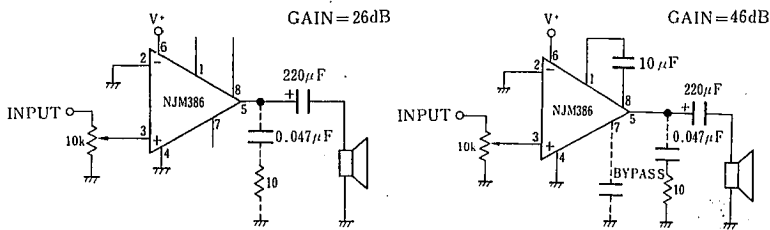

■ POWER DISSIPATION VS. AMBIENT TEMPERATURE

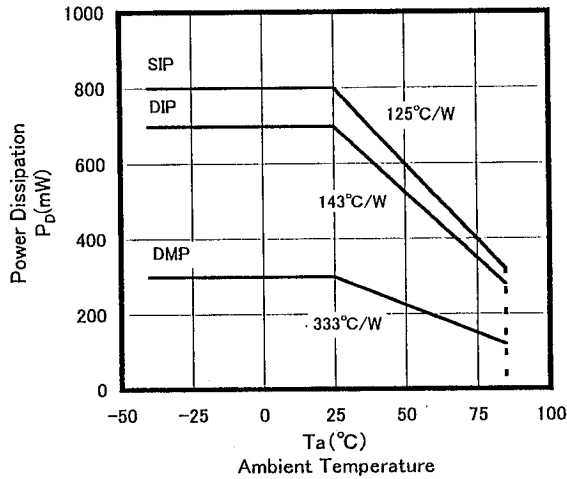

■ NOTICE WHEN APPLICATION

• Prevention of Oscillation

It is recommended to insert capacitors at around the supply source and the GND pins with the value of $0.1\mu\text{F}$ and more than $100\mu\text{F}$ which are featuring higher frequency efficiency.

When start of oscillation accordingly to the load condition, it is recommendable to insert the resistor of 10Ω and the capacitor of $0.047\mu\text{F}$ between the output and the GND pins.

• How to use the Input Resistor (TYP. $50\text{k}\Omega$)

The input resistors have much deviation in value generally, so that it is recommended not to use them as the constant of the circuit. The countermeasure to be recommended is to apply the resistor of higher in value, which is so higher to be able to ignore the input deviation ($3\text{k}\Omega$ approximately) in parallel application.

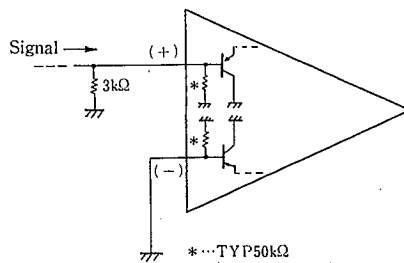

5

- **Maintenance of Output Offset Voltage**

By making connection of both input pins with low value resistors (below 10KΩ approximately) to GND, the output offset voltage is automatically set in the medium range value of the supply source. However, the DC Gain of NJM386 is approximately at 20 times in value, so that when keeping one side input pin open, and the other side to GND on DC condition. The voltage drop caused by input resistor X input bias current, that is, (input resistor X input bias current) X 20 times voltage is to be added to the output offset voltage, and that the medium range output voltage is to be sheared, which in the result, no distortion output oscillation range shall be decreased.

In regard to dealing with the input pin, it is recommendable to put the input pin into the GND at first, and the other side of signal input pin, to be connected into GND with the resistor of less than about 10KΩ on DC condition .

- **Concerning Cross-Over Distortion**

NJM386 in application, the cross-over distortion is to be generated in the high band operation.

The countermeasure for that, it is recommendable to have it replaced with NJM386B (But, be careful in prevention of oscillation). And for prevention of the cross-over distortion, it is recommendable to apply NJM2072, NJM2073.

- **The Application Purpose and Recommended Value of the External parts.**

EXTERNAL PARTS	APPLICATION PURPOSE	RECOMMENDED VALUE	REMARKS
R _S	Current like noise reduction V ₀₀ stabilization	Below 10 KΩ	The noise becomes high when the input pin open.
C _{IN}	V ₀₀ stabilization	1μF	It is not required in case when there is no DC offset in the input signal.
C _{P1}	V ⁺ stabilization	≅ C _{CCUP}	It can be decreased in value when the output impedance source is low.
C _{P2}	Oscillation prevention	0.1μF	Insert near around the supply source and GND pins.
C _B	Ripple rejection to V ₀ by way of V ⁺	47μF	It is not required when the V ⁺ is stabilized.
C _O	Oscillation prevention	0.047μF	To be decided in value according to load condition.
R _O	Oscillation prevention	10Ω	To be decided in value according to load condition.
C _{CCUP}	Output DC Decoupling	220μF when R _L = 8Ω	Low band cutoff frequency(f _L) shall be decided by C _{CCUP} R _L . When C _{CCUP} is less in value, f _L is to be increased.

NJM386 Recommended Circuit

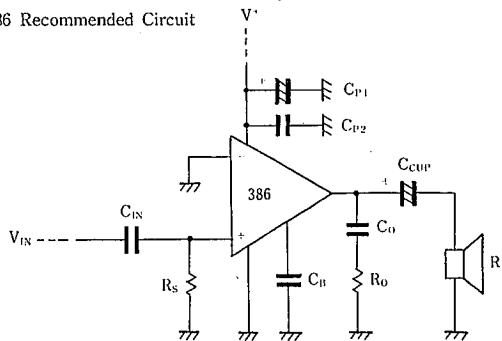

■ MUTING CIRCUIT EXAMPLE

(1) The way how to apply DC voltage to -INPUT pin.

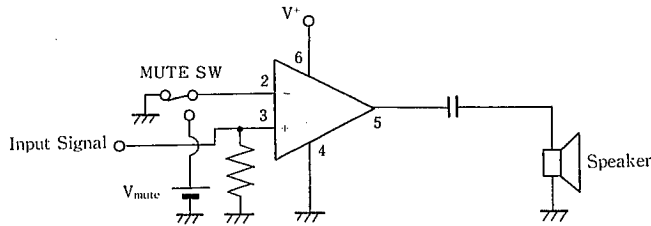

According to this method, when applying DC voltage, V_{mute} to -INPUT PIN, the output voltage V_o at voltage gain A_v will be,

$$V_o = V^+ / 2 - V_{mute} * A_v$$

It is the way that the muting shall be proceeded by keeping V_o saturating at the GND side. Now, the output is saturated, so that there is no leakage of muting. However, when the peak value of signal input is increased higher than about the value of $1/4 V_{mute}$, the leakage of muting shall be started.

(2) The way, how to connect gain. No. 8 PIN to GND

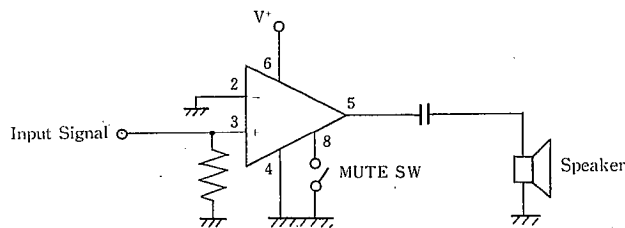

It is the way, originally that the pin which is to be used for adjusting the gain of NJM386, but to have it applied in connecting to GND side, and by doing so, to stop the early stage motion, but keeping on for muting operation. The early stage motion shall be stopped, therefore, the precise muting shall be proceeded with less leakage on operation.

(3) The way how to proceed casting the BY PASS pin on V+ side

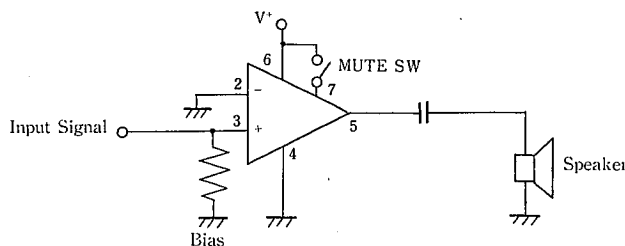

By this way, the bias circuit within IC, to be stopped and then, further for stopping motion of driver level, and at the output level. However, the input level alone is operating, so that a slight leakage of signal to the output pin through inside resistor to be occurred. The leakage level is to be inverse proportion to load, therefore, it is necessary to check accordingly through the load condition.

5

(Note) Improper Muting Circuit

Never to apply with the Muting Circuit, because of the fact that, there are cases when the muting does not operate depending on IC to be used.

The way how to connect the BY PASS PIN to GND.

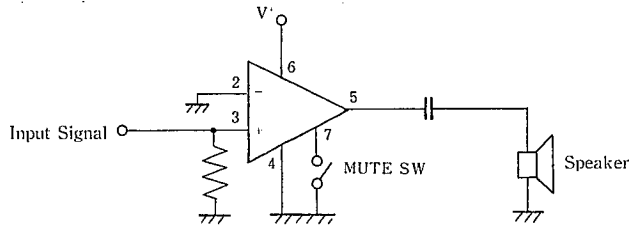

APPLICATION CIRCUIT EXAMPLE

Amplifier 1

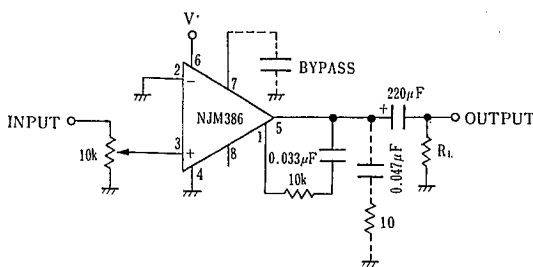

Low Distortion Power Wienbridge Oscillator

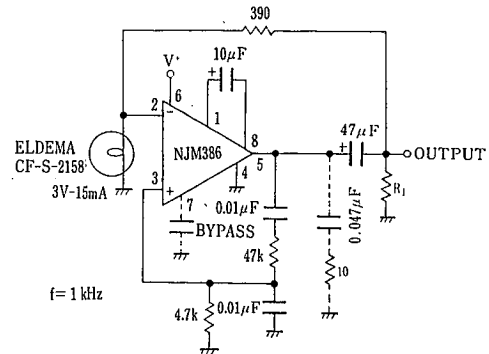

Amplifier 2

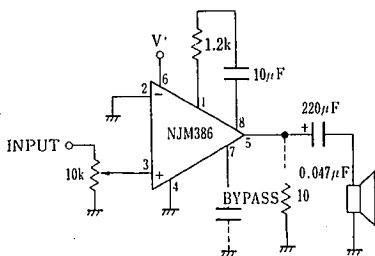

Square Wave Oscillator

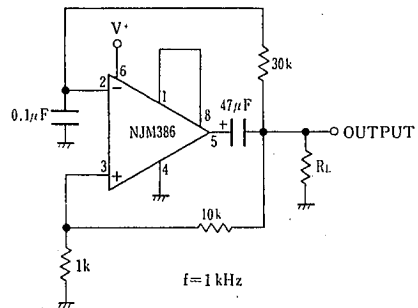

WIDE RANGE APPLICATION

NJM386 is a small output power amplifier with minimum external parts, and also the gain of which is fixed, yet it can be made changeable in value, too.

GAIN CONTROL

To make the NJM386 a more versatile amplifier, two pins (1 and 8) are provided the gain control. With pins 1 and 8 open the 1.35kΩ resistor sets the gain at 20 (26dB). If a capacitor is put from pin 1 to 8, bypassing the 1.35kΩ resistor, the gain will go up to 200 (46dB). If a resistor is placed in series with the capacitor, the gain can be set to any value from 20 to 200. Gain control can also be done by capacitively coupling a resistor (or FET) from pin 1 to ground.

Additional external components can be placed in parallel with the internal feedback resistors to tailor the gain and frequency response for individual applications. For example, we can compensate poor speaker bass response by frequency shaping the feedback path. This is done with a series RC from pin 1 to 5 (paralleling the internal 15kΩ resistor). For 6dB effective bass boost: R ≅ 15kΩ, the lowest value for good stable operation is R_{MIN} = 10kΩ if pin 8 is open. If pins 1 and 8 are bypassed then R as low as 2kΩ can be used. This restriction is because the amplifier is only compensated for closed-loop gains greater than 9.

■ TYPICAL CHARACTERISTICS

Operating Current vs. Operating Voltage
($T_a = 25^\circ\text{C}$)

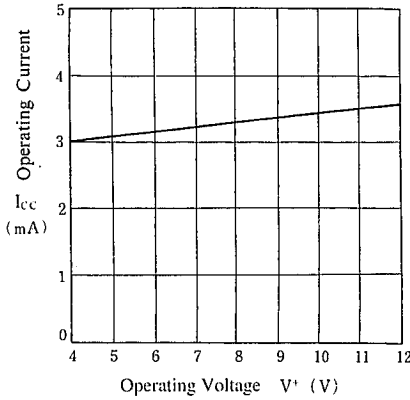

Maximum Output Voltage Swing vs. Operating Voltage
(Standard Application, $T_a = 25^\circ\text{C}$)

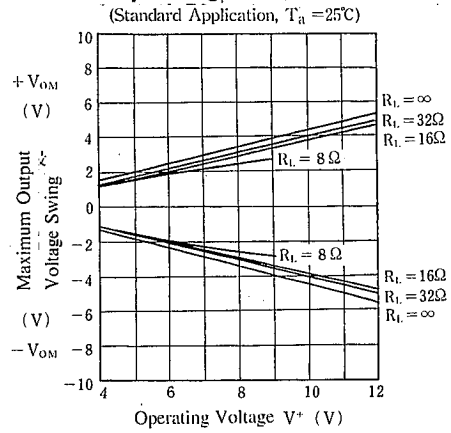

Voltage Gain vs. Frequency
($T_a = 25^\circ\text{C}$)

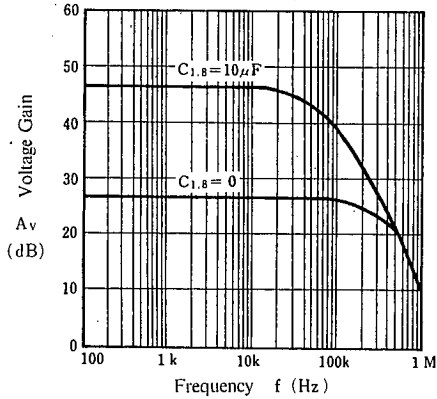

Power Supply Rejection Ratio vs. Frequency
($V^* = 6\text{V}$, $A_v = 26\text{dB}$, $T_a = 25^\circ\text{C}$)

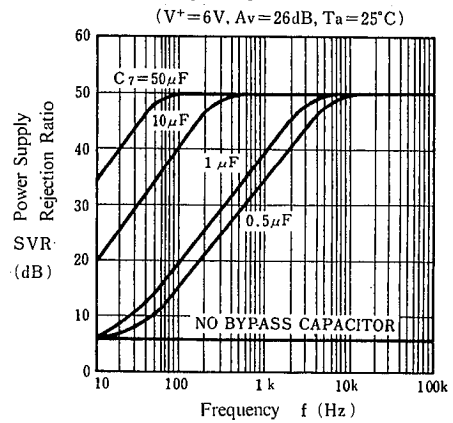

Total Harmonic Distortion vs. Frequency
($V^* = 6\text{V}$, $R_l = 8\Omega$, $P_o = 125\text{mW}$, $A_v = 26\text{dB}$, $T_a = 25^\circ\text{C}$)

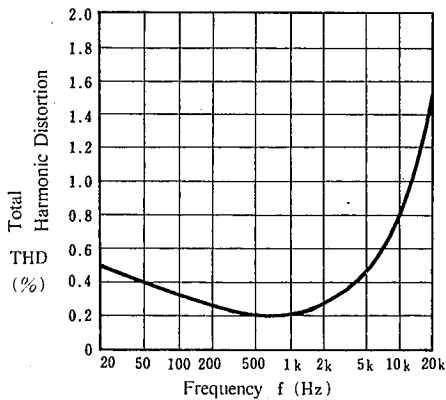

Total Harmonic Distortion vs. Output Power
($V^* = 6\text{V}$, $R_l = 8\Omega$, $f = 1\text{kHz}$)

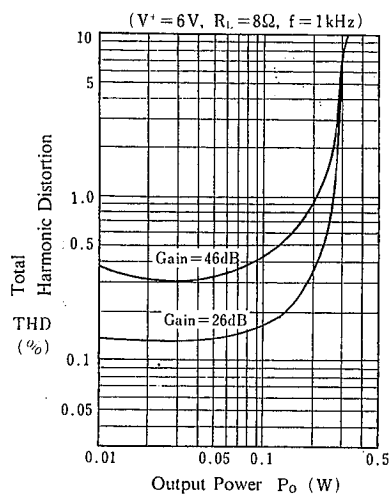

5

■ TYPICAL CHARACTERISTICS

Power Dissipation vs. Output Power

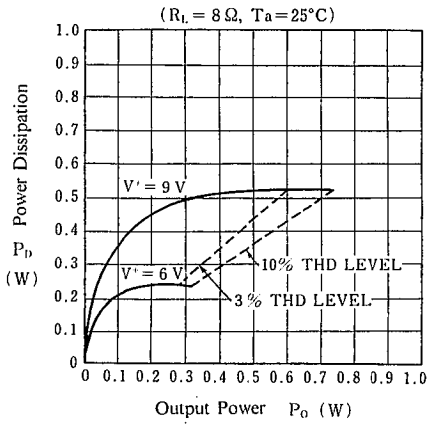

Power Dissipation vs. Output Power

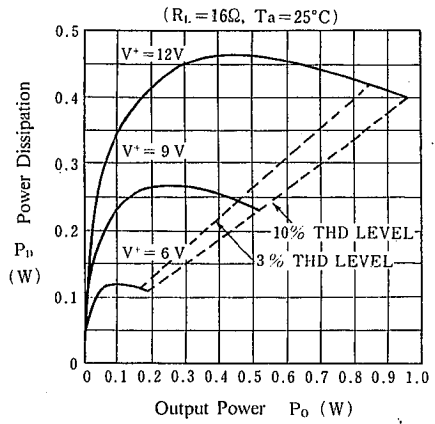

Power Dissipation vs. Output Power

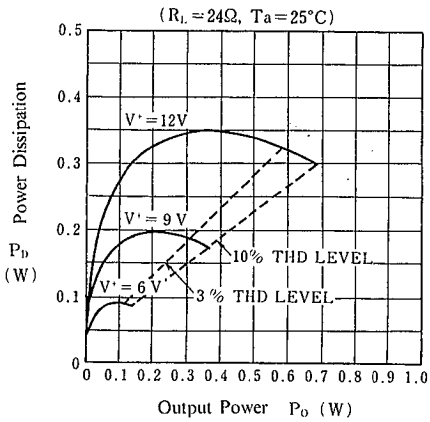

Power Dissipation vs. Output Power

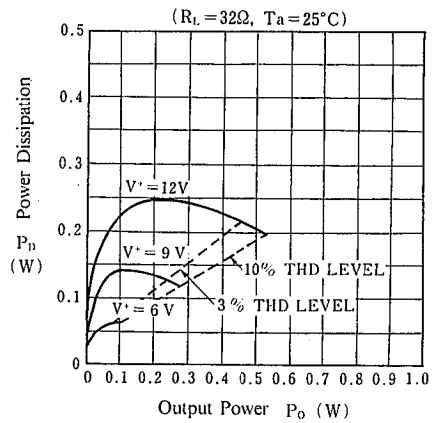

Frequency Response with Bass Boost

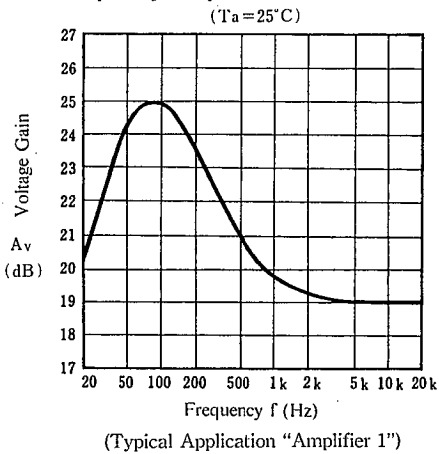

5

■ TYPICAL CHARACTERISTICS

Operating Current vs. Temperature

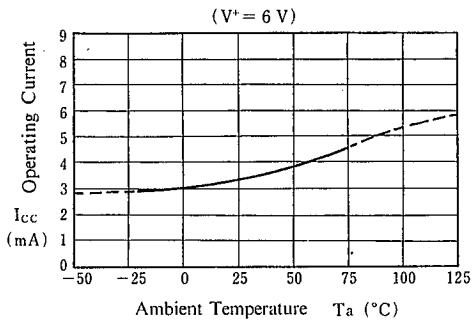

Voltage Gain vs. Temperature

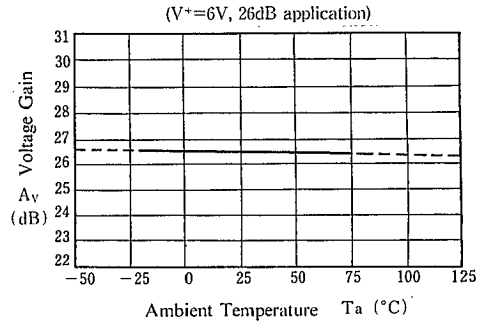

MEMO

[CAUTION]

The specifications on this databook are only given for information, without any guarantee as regards either mistakes or omissions. The application circuits in this databook are described only to show representative usages of the product and not intended for the guarantee or permission of any right including the industrial rights.

Mouser Electronics

Authorized Distributor

Click to View Pricing, Inventory, Delivery & Lifecycle Information:

[NJR:](#)

[NJM386BL](#) [NJM386BD](#) [NJM386BM](#) [NJM386M-TE1](#) [NJM386M-TE3](#) [NJM386M-TE2](#) [NJM386E-TE2](#) [NJM386E-TE1](#)
[NJM386D](#) [NJM386M](#) [NJM386BM-TE1](#) [NJM386BM-TE2](#) [NJM386BE-TE2](#) [NJM386BE-TE1](#) [NJM#386E-TE1](#)
[NJM#386E-TE2](#) [NJM#386BE-TE2](#) [NJM#386BE-TE1](#)