

NPN Silicon Darlington Transistors

BC 617
BC 618

- High current gain
- High collector current

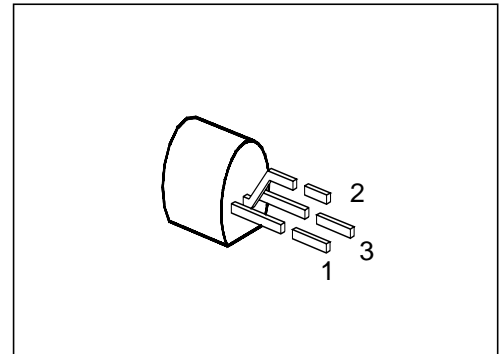

Type	Marking	Ordering Code	Pin Configuration			Package ¹⁾
			1	2	3	
BC 617 BC 618	–	Q62702-C1137 Q62702-C1138	C	B	E	TO-92

Maximum Ratings

Parameter	Symbol	Values		Unit
		BC 617	BC 618	
Collector-emitter voltage	V_{CE0}	40	55	V
Collector-base voltage	V_{CB0}	50	80	
Emitter-base voltage	V_{EB0}	12		
Collector current	I_C	500		mA
Peak collector current	I_{CM}	800		
Base current	I_B	100		
Peak base current	I_{BM}	200		
Total power dissipation, $T_c = 66\text{ °C}$	P_{tot}	625		mW
Junction temperature	T_j	150		°C
Storage temperature range	T_{stg}	– 65 ... + 150		

Thermal Resistance

Junction - ambient	$R_{th JA}$	≤ 200	K/W
Junction - case ²⁾	$R_{th JC}$	≤ 135	

¹⁾ For detailed information see chapter Package Outlines.

²⁾ Mounted on Al heat sink 15 mm × 25 mm × 0.5 mm.

Electrical Characteristics

at $T_A = 25\text{ °C}$, unless otherwise specified.

Parameter	Symbol	Values			Unit
		min.	typ.	max.	

DC characteristics

Collector-emitter breakdown voltage $I_C = 10\text{ mA}$	$V_{(BR)CE0}$				V
BC 617		40	–	–	
BC 618		55	–	–	
Collector-base breakdown voltage $I_C = 100\text{ }\mu\text{A}$	$V_{(BR)CB0}$				
BC 617		50	–	–	
BC 618		80	–	–	
Emitter-base breakdown voltage $I_E = 10\text{ }\mu\text{A}$	$V_{(BR)EB0}$	12	–	–	
Collector cutoff current $V_{CB} = 40\text{ V}$	I_{CB0}				nA
BC 617		–	–	100	
$V_{CB} = 60\text{ V}$	BC 618	–	–	100	nA
$V_{CB} = 40\text{ V}, T_A = 150\text{ °C}$	BC 617	–	–	10	μA
$V_{CB} = 60\text{ V}, T_A = 150\text{ °C}$	BC 618	–	–	10	μA
Emitter cutoff current $V_{EB} = 4\text{ V}$	I_{EB0}	–	–	100	nA
DC current gain $I_C = 100\text{ }\mu\text{A}; V_{CE} = 5\text{ V}$	h_{FE}				–
BC 617		4000	–	–	
BC 618		2000	–	–	
$I_C = 10\text{ mA}; V_{CE} = 5\text{ V}^{1)}$	BC 617	10000	–	–	
BC 618		4000	–	–	
$I_C = 200\text{ mA}; V_{CE} = 5\text{ V}^{1)}$	BC 617	20000	–	70000	
BC 618		10000	–	50000	
$I_C = 1000\text{ mA}; V_{CE} = 5\text{ V}^{1)}$	BC 617	10000	–	–	
BC 618		4000	–	–	
Collector-emitter saturation voltage ¹⁾ $I_C = 200\text{ mA}; I_B = 0.2\text{ mA}$	V_{CEsat}	–	–	1.1	V
Base-emitter saturation voltage ¹⁾ $I_C = 200\text{ mA}; I_B = 0.2\text{ mA}$	V_{BEsat}	–	–	1.6	

¹⁾ Pulse test: $t \leq 300\text{ }\mu\text{s}, D \leq 2\%$.

Electrical Characteristics

at $T_A = 25^\circ\text{C}$, unless otherwise specified.

Parameter	Symbol	Values			Unit
		min.	typ.	max.	

AC characteristics

Transition frequency $I_C = 50\text{ mA}, V_{CE} = 5\text{ V}, f = 20\text{ MHz}$	f_t	–	150	–	MHz
Output capacitance $V_{CB} = 10\text{ V}, f = 1\text{ MHz}$	C_{obo}	–	3.5	–	pF

Total power dissipation $P_{tot} = f(T_A; T_C)$

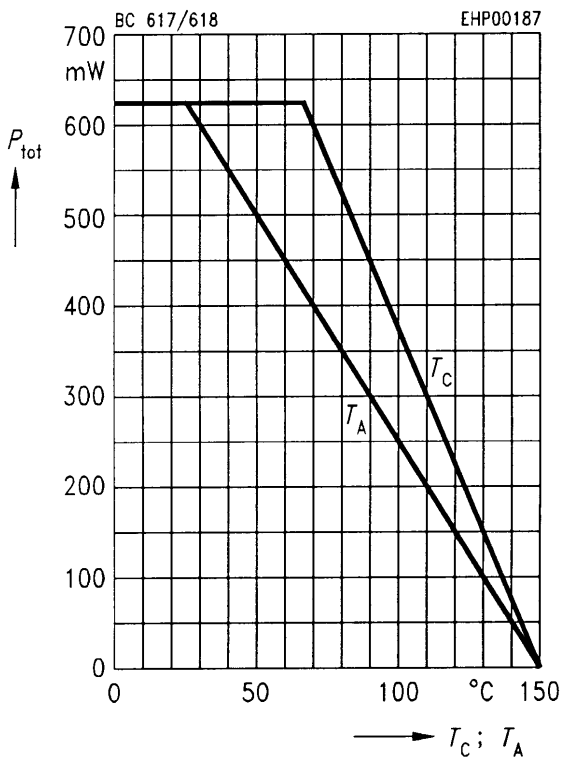

Collector cutoff current $I_{CBO} = f(T_A)$

$V_{CB} = 40\text{ V}, 60\text{ V}$

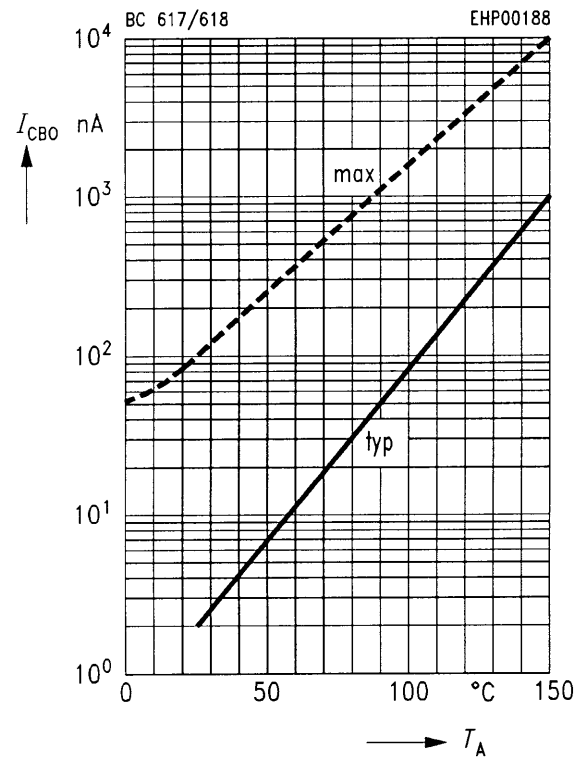

Permissible pulse load $R_{thJA} = f(t_p)$

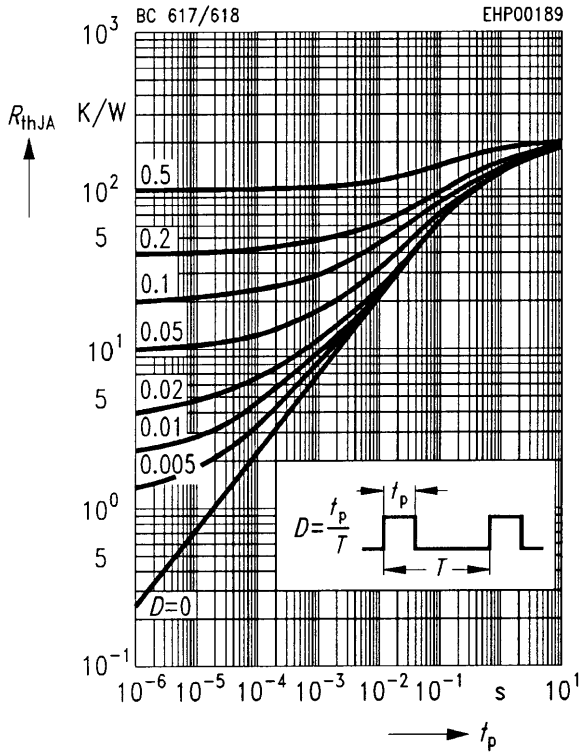

Transition frequency $f_T = f(I_C)$

$V_{CE} = 5\text{ V}, f = 20\text{ MHz}$

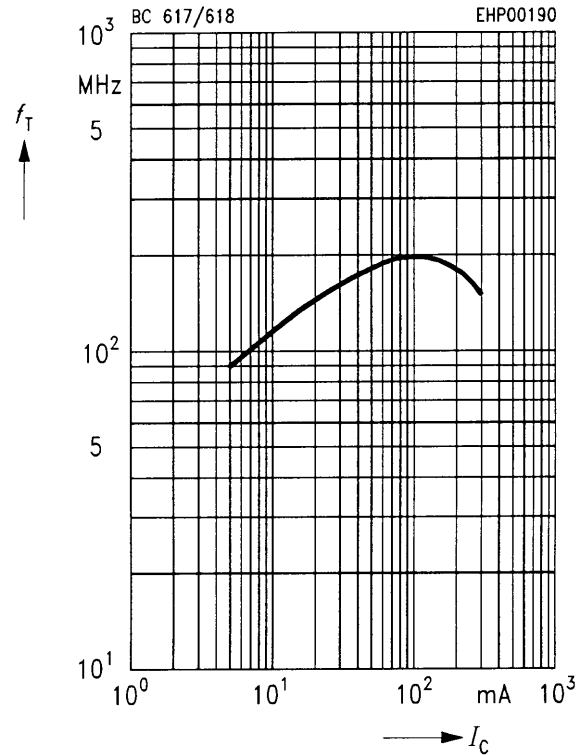

Collector-emitter saturation voltage

$V_{CEsat} = f(I_C)$

$h_{FE} = 1000$, parameter = T_A

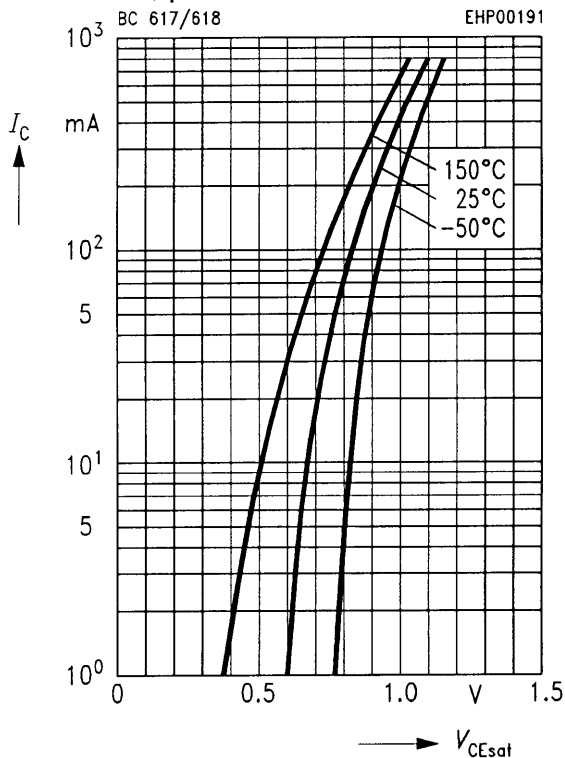

Base-emitter saturation voltage

$V_{BEsat} = f(I_C)$

$h_{FE} = 1000$, parameter = T_A

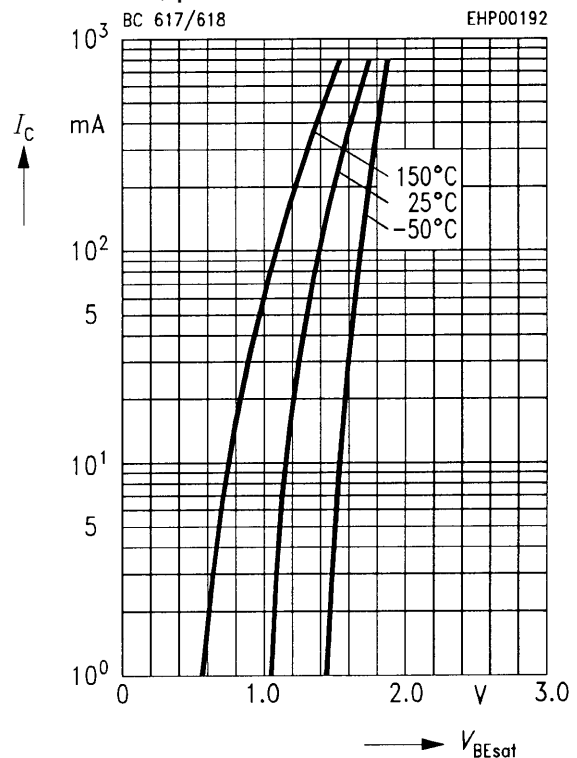

DC current gain $h_{FE} = f(I_C)$

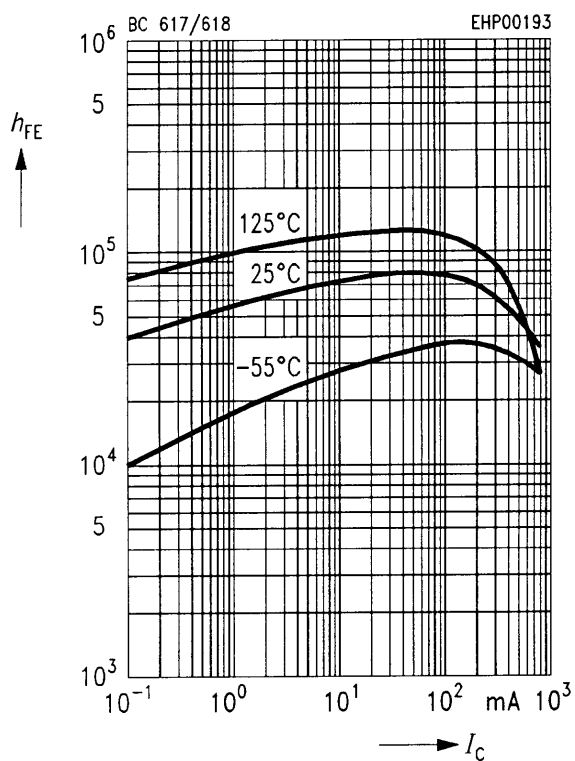

Capacitance $C = f(V_{EB}, V_{CB})$

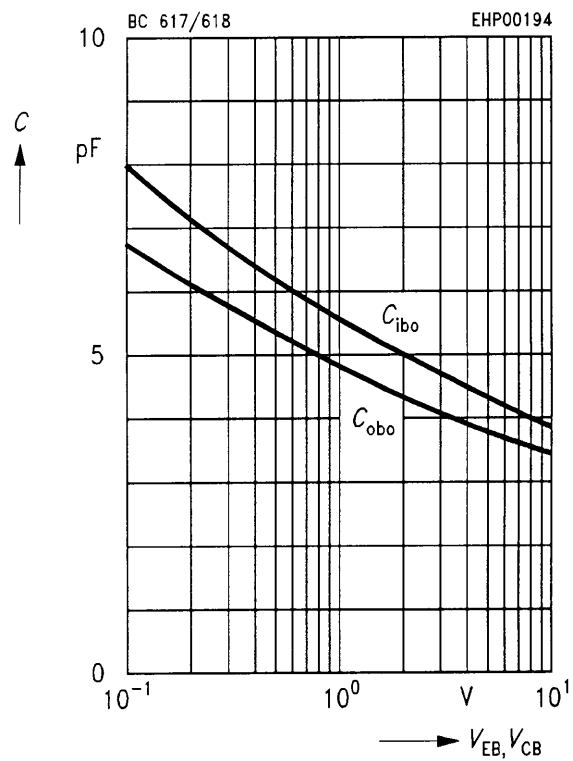

This datasheet has been download from:

www.datasheetcatalog.com

Datasheets for electronics components.