

Switching (30V, ±10A)

RSS100N03

●Features

- 1) Low on-resistance.
- 2) Built-in G-S Protection Diode.
- 3) Small and Surface Mount Package (SOP8).

●Applications

Power switching, DC/DC converter.

●Structure

- Silicon N-channel MOS FET

●External dimensions (Units : mm)

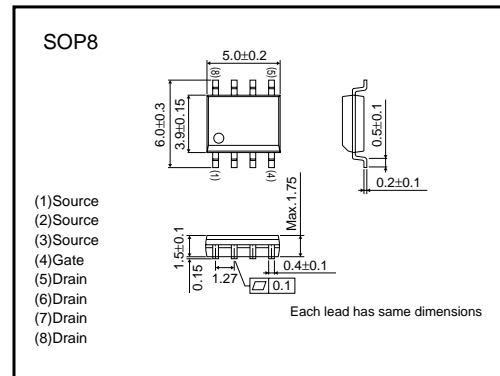

●Equivalent circuit

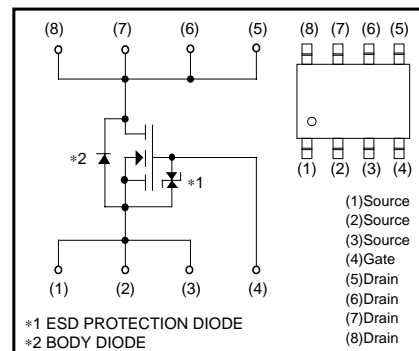

*A protection diode is included between the gate and the source terminals to protect the diode against static electricity when the product is in use. Use the protection circuit when the fixed voltages are exceeded.

●Absolute maximum ratings (Ta=25°C)

Parameter	Symbol	Limits	Unit
Drain-source voltage	V_{DSS}	30	V
Gate-source voltage	V_{GSS}	20	V
Drain current	Continuous	I_D	±10 A
	Pulsed	I_{DP}	±40 A *
Source current (Body diode)	Continuous	I_S	1.6 A
	Pulsed	I_{SP}	6.4 A *
Total power dissipation (Tc=25°C)	P_D	2	W
Channel temperature	Tch	150	°C
Storage temperature	Tstg	-55~+150	°C

*1 $P_w \leq 10 \mu s$, Duty cycle $\leq 1\%$

Transistor

●Thermal resistance (Ta=25°C)

Parameter	Symbol	Limits	Unit
Channel to ambient	Rth (ch-A)	62.5	°C / W

●Electrical characteristics (Ta=25°C)

Parameter	Symbol	Min.	Typ.	Max.	Unit	Conditions
Gate-source leakage	I _{GSS}	-	-	10	μA	V _{GS} =20V, V _{DS} =0V
Drain-source breakdown voltage	V _{(BR) DSS}	30	-	-	V	I _D =1mA, V _{GS} =0V
Zero gate voltage drain current	I _{DSS}	-	-	10	μA	V _{DS} =30V, V _{GS} =0V
Gate threshold voltage	V _{GS(th)}	1.0	-	2.5	V	V _{DS} =10V, I _D =1mA
Static drain-source on-starte resistance	R _{DS(on)}	-	9.5	13.0	mΩ	I _D =±10A, V _{GS} =10V *
		-	12.5	17.2		I _D =±10A, V _{GS} =4.5V *
		-	13.5	18.5		I _D =±10A, V _{GS} =4V *
Forward transfer admittance	Y _{fs}	6.0	-	-	S	I _D =±10A, V _{DS} =10V *
Input capacitance	C _{iss}	-	1070	-	pF	V _{DS} =10V
Output capacitance	C _{oss}	-	320	-	pF	V _{GS} =0V
Reverse transfer capacitance	C _{rss}	-	200	-	pF	f=1MHz
Turn-on delay time	t _{d(on)}	-	10	-	ns	I _D =5A, V _{DD} ≐15V *
Rise time	t _r	-	16	-	ns	V _{GS} =10V *
Turn-off delay time	t _{d(off)}	-	55	-	ns	R _L =3.0Ω *
Fall time	t _f	-	24	-	ns	R _{GS} =10Ω *
Total gate charge	Q _g	-	14	-	nC	V _{DD} ≐15V *
Gate-source charge	Q _{gs}	-	2.7	-	nC	V _{GS} =5V *
Gate-drain charge	Q _{gd}	-	5.3	-	nC	I _D =±10A *

*Pulsed

●Body diode characteristics (Source-Drain Characteristics) (Ta=25°C)

Parameter	Symbol	Min.	Typ.	Max.	Unit	Conditions
Forward voltage	V _{SD}	-	-	1.2	V	I _S =6.4A, V _{GS} =0V *

*Pulsed

●Electrical characteristic curves

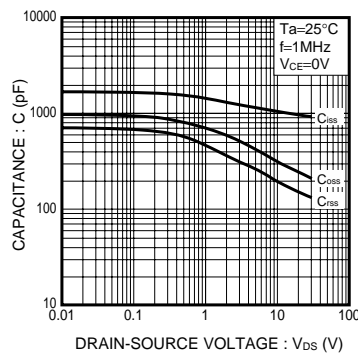

Fig.1 Typical Capacitance vs. Drain-Source Voltage

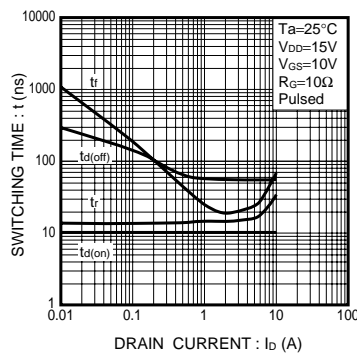

Fig.2 Switching Characteristics

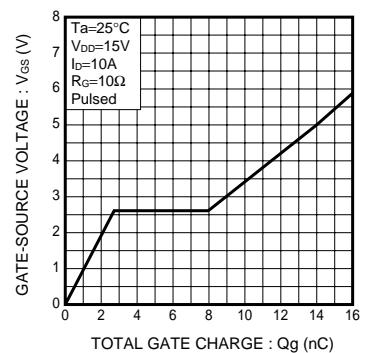

Fig.3 Dynamic Input Characteristics

Transistor

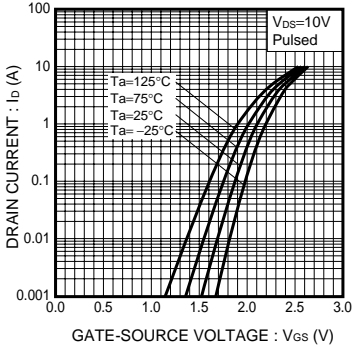

Fig.4 Typical Transfer Characteristics

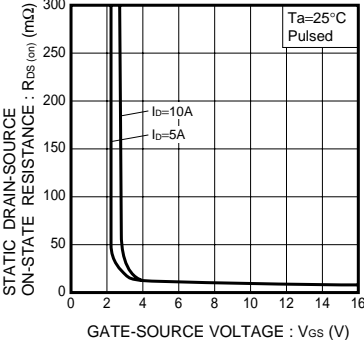

Fig.5 Static Drain-Source On-State Resistance vs. Gate-Source Voltage

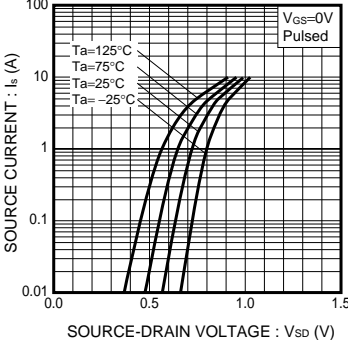

Fig.6 Source Current vs. Source-Drain Voltage

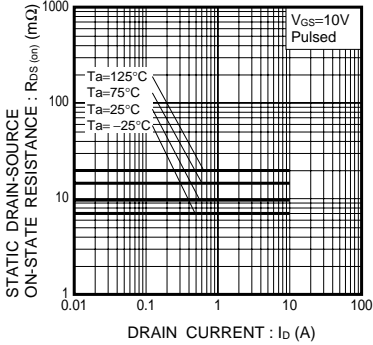

Fig.7 Static Drain-Source On-State Resistance vs. Drain Current (I)

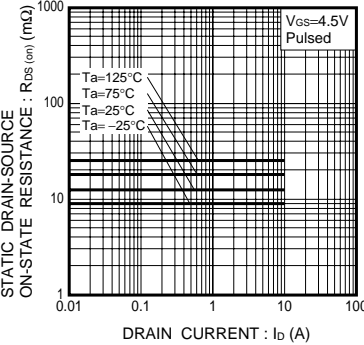

Fig.8 Static Drain-Source On-State Resistance vs. Drain Current (II)

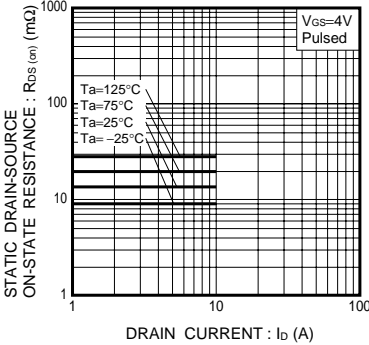

Fig.9 Static Drain-Source On-State Resistance vs. Drain Current (III)

This datasheet has been download from:

www.datasheetcatalog.com

Datasheets for electronics components.