

NTJS4160N

Power MOSFET

30 V, 3.2 A, Single N-Channel, SC-88

Features

- Offers an Low $R_{DS(on)}$ Solution in the SC-88 Package
- Low Profile (< 1.1 mm) Allows it to fit Easily into Extremely Thin Environments such as Portable Electronics
- Operates at Standard Logic Level Gate Drive
- Low Gate Charge
- This is a Pb-Free Device

Applications

- DC-DC Converters (Buck and Boost Circuit)
- Optimized for Battery Powered Portable Equipment such as, Cell Phones, PDAs, Media Players, etc.
- Load Management
- Battery Charging and OV IC Protection Circuits

MAXIMUM RATINGS ($T_J = 25^\circ\text{C}$ unless otherwise stated)

Parameter		Symbol	Value	Unit	
Drain-to-Source Voltage		V_{DSS}	30	V	
Gate-to-Source Voltage		V_{GS}	± 20	V	
Continuous Drain Current (Note 1)	Steady State	$T_A = 25^\circ\text{C}$	I_D	2.6	A
		$T_A = 85^\circ\text{C}$		1.9	
	$t \leq 1\text{ s}$	$T_A = 25^\circ\text{C}$		3.2	
Power Dissipation (Note 1)	Steady State	$T_A = 25^\circ\text{C}$	P_D	0.62	W
	$t \leq 1\text{ s}$			0.95	
Continuous Drain Current (Note 2)	Steady State	$T_A = 25^\circ\text{C}$	I_D	1.8	A
		$T_A = 85^\circ\text{C}$		1.3	
Power Dissipation (Note 2)		$T_A = 25^\circ\text{C}$	P_D	0.3	W
Pulsed Drain Current	$t_p = 10\ \mu\text{s}$	I_{DM}	10	A	
Operating Junction and Storage Temperature		T_J, T_{STG}	-55 to 150	$^\circ\text{C}$	
Source Current (Body Diode)		I_S	1.3	A	
Lead Temperature for Soldering Purposes (1/8" from case for 10 s)		T_L	260	$^\circ\text{C}$	

Stresses exceeding Maximum Ratings may damage the device. Maximum Ratings are stress ratings only. Functional operation above the Recommended Operating Conditions is not implied. Extended exposure to stresses above the Recommended Operating Conditions may affect device reliability.

1. Surface mounted on FR4 board using 1 in sq pad size (Cu area = 1.127 in sq [2 oz] including traces).
2. Surface mounted on FR4 board using the minimum recommended pad size.



ON Semiconductor®

<http://onsemi.com>

$V_{(BR)DSS}$	$R_{DS(on)}$ TYP	I_D Max
30 V	45 m Ω @ 10 V	3.2 A
	65 m Ω @ 4.5 V	

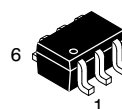

SC-88 (SOT 363)
CASE 419B
STYLE 28

MARKING DIAGRAM

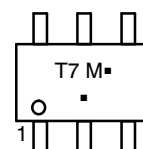

T7 = Device Code
M = Date Code
▪ = Pb-Free Package
(Note: Microdot may be in either location)

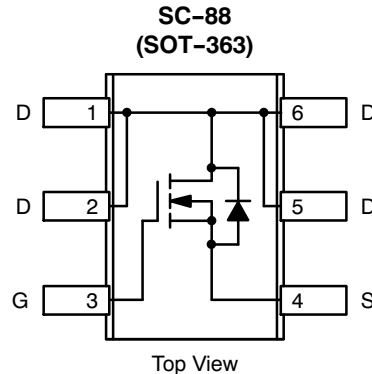

ORDERING INFORMATION

Device	Package	Shipping†
NTJS4160NT1G	SC-88 (Pb-Free)	3000 Units/Reel

†For information on tape and reel specifications, including part orientation and tape sizes, please refer to our Tape and Reel Packaging Specifications Brochure, BRD8011/D.

NTJS4160N

THERMAL RESISTANCE RATINGS

Parameter	Symbol	Max	Unit
Junction-to-Ambient – Steady State (Note 3)	$R_{\theta JA}$	200	°C/W
Junction-to-Ambient – $t \leq 1$ s (Note 3)	$R_{\theta JA}$	132	
Junction-to-Ambient – Steady State (Note 4)	$R_{\theta JA}$	420	

3. Surface mounted on FR4 board using 1 in sq pad size (Cu area = 1.127 in sq [2 oz] including traces).
 4. Surface mounted on FR4 board using the minimum recommended pad size.

ELECTRICAL CHARACTERISTICS ($T_J = 25^\circ\text{C}$ unless otherwise stated)

Parameter	Symbol	Test Condition	Min	Typ	Max	Unit
-----------	--------	----------------	-----	-----	-----	------

OFF CHARACTERISTICS

Drain-to-Source Breakdown Voltage	$V_{(BR)DSS}$	$V_{GS} = 0$ V, $I_D = 250$ μ A	30			V
Drain-to-Source Breakdown Voltage Temperature Coefficient	$V_{(BR)DSS}/T_J$	$I_D = 250$ μ A, ref to 25°C		20		mV/°C
Zero Gate Voltage Drain Current	I_{DSS}	$V_{GS} = 0$ V, $V_{DS} = 24$ V	$T_J = 25^\circ\text{C}$		1.0	μ A
			$T_J = 125^\circ\text{C}$		10	
Gate-to-Source Leakage Current	I_{GSS}	$V_{DS} = 0$ V, $V_{GS} = +20$ V			100	nA
		$V_{DS} = 0$ V, $V_{GS} = -20$ V			-200	

ON CHARACTERISTICS (Note 5)

Gate Threshold Voltage	$V_{GS(TH)}$	$V_{GS} = V_{DS}$, $I_D = 250$ μ A	0.8		2.4	V
Gate Threshold Temperature Coefficient	$V_{GS(TH)}/T_J$			-5.0		mV/°C
Drain-to-Source On Resistance	$R_{DS(on)}$	$V_{GS} = 10$ V, $I_D = 2.6$ A		45	60	m Ω
		$V_{GS} = 4.5$ V, $I_D = 2.2$ A		65	85	
Forward Transconductance	g_{FS}	$V_{GS} = 5.0$ V, $I_D = 3.0$ A		4.2		S

CHARGES AND CAPACITANCES

Input Capacitance	C_{ISS}	$V_{GS} = 0$ V, $f = 1.0$ MHz, $V_{DS} = 10$ V		230		pF
Output Capacitance	C_{OSS}			62		
Reverse Transfer Capacitance	C_{RSS}			39		
Total Gate Charge	$Q_G(TOT)$	$V_{GS} = 4.5$ V, $V_{DS} = 15$ V, $I_D = 2.6$ A		2.75		nC
Threshold Gate Charge	$Q_G(TH)$			0.37		
Gate-to-Source Charge	Q_{GS}			0.87		
Gate-to-Drain Charge	Q_{GD}			1.1		

SWITCHING CHARACTERISTICS (Note 6)

Turn-On Delay Time	$t_{d(ON)}$	$V_{GS} = 4.5$ V, $V_{DD} = 15$ V, $I_D = 1.0$ A, $R_G = 6.0$ Ω		8.7	15	ns
Rise Time	t_r			7.2	13	
Turn-Off Delay Time	$t_{d(OFF)}$			10.9	19	
Fall Time	t_f			1.9	4.0	

DRAIN-SOURCE DIODE CHARACTERISTICS

Forward Diode Voltage	V_{SD}	$V_{GS} = 0$ V, $I_S = 1.3$ A	$T_J = 25^\circ\text{C}$	0.79	1.2	V
			$T_J = 125^\circ\text{C}$	0.67		
Reverse Recovery Time	t_{RR}	$V_{GS} = 0$ V, $dI_S/dt = 100$ A/ μ s, $I_S = 1.3$ A		10.3		ns
Charge Time	T_a			7.2		
Discharge Time	T_b			3.1		
Reverse Recovery Charge	Q_{RR}			4.0		

5. Pulse Test: pulse width ≤ 300 μ s, duty cycle $\leq 2\%$.
 6. Switching characteristics are independent of operating junction temperatures.

NTJS4160N

TYPICAL PERFORMANCE CURVES ($T_J = 25^\circ\text{C}$ unless otherwise noted)

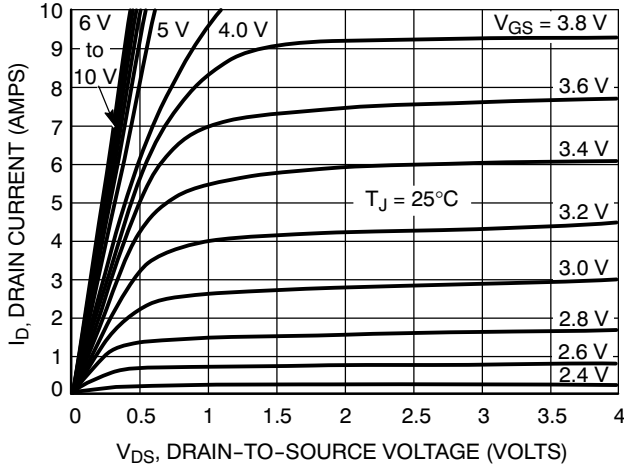

Figure 1. On-Region Characteristics

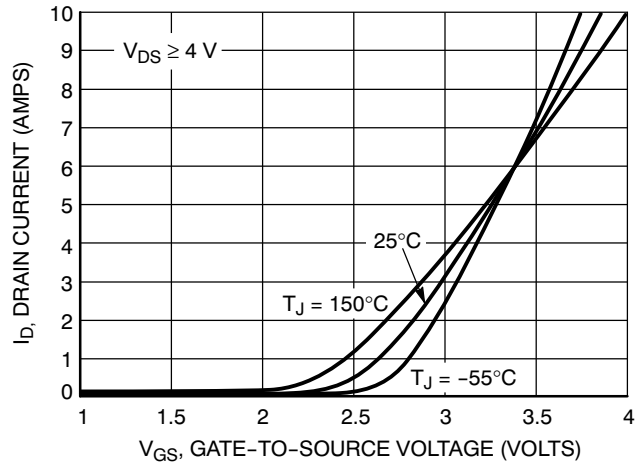

Figure 2. Transfer Characteristics

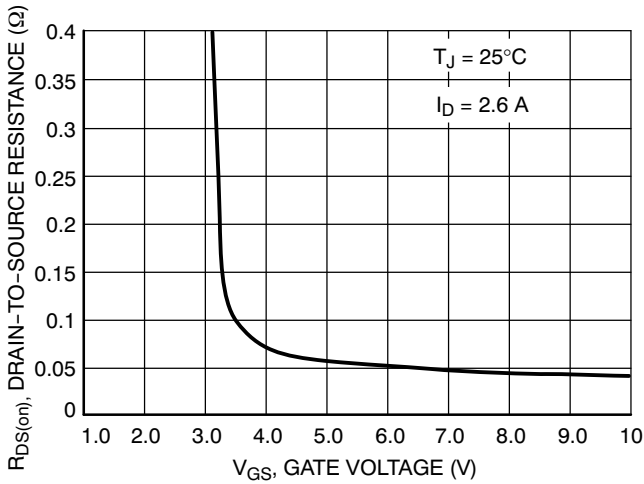

Figure 3. On-Resistance vs. Gate Voltage

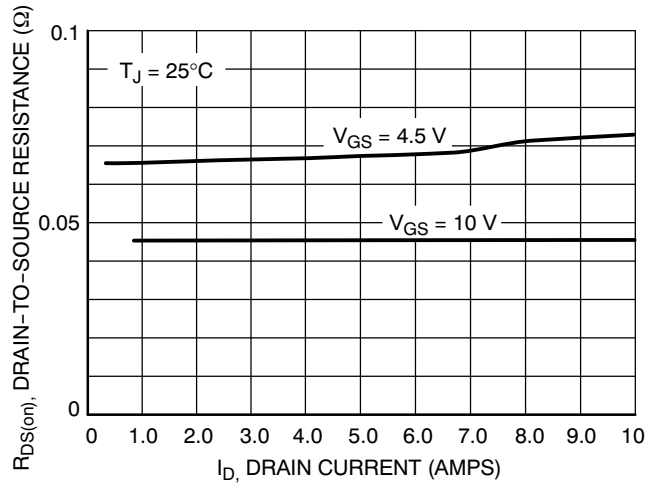

Figure 4. On-Resistance vs. Drain Current and Gate Voltage

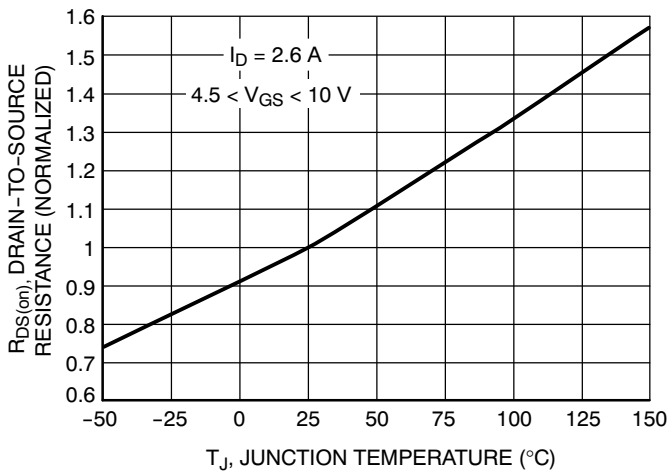

Figure 5. On-Resistance Variation with Temperature

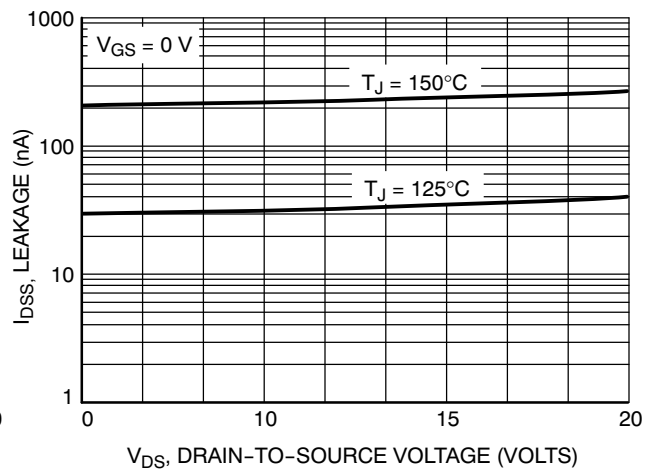

Figure 6. Drain-to-Source Leakage Current vs. Voltage

NTJS4160N

TYPICAL PERFORMANCE CURVES ($T_J = 25^\circ\text{C}$ unless otherwise noted)

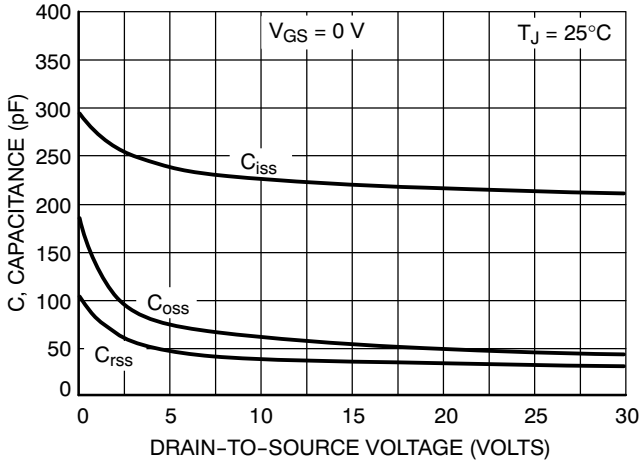

Figure 7. Capacitance Variation

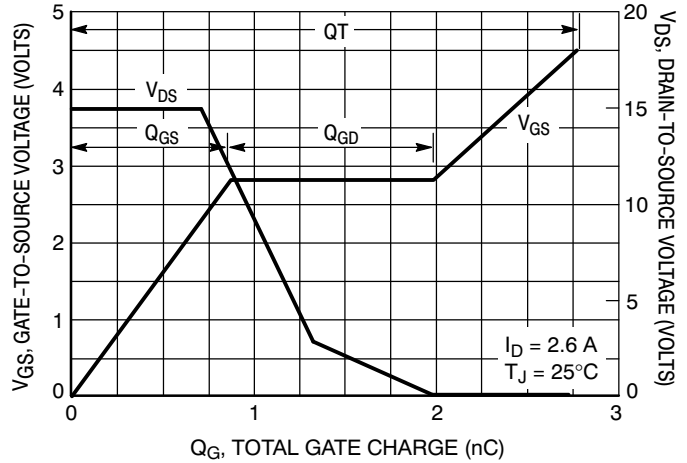

Figure 8. Gate-to-Source and Drain-to-Source Voltage vs. Total Charge

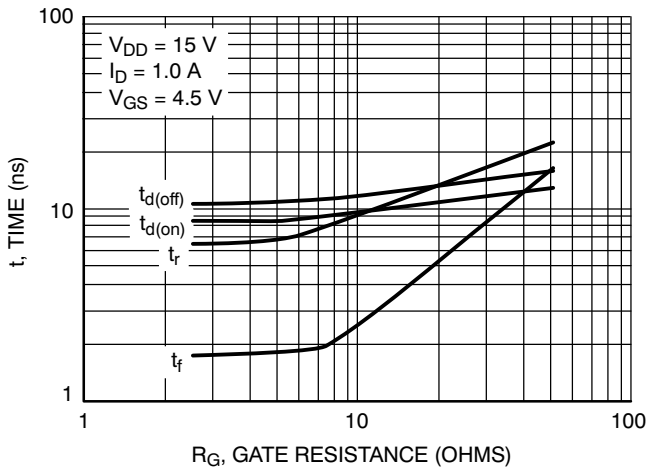

Figure 9. Resistive Switching Time Variation vs. Gate Resistance

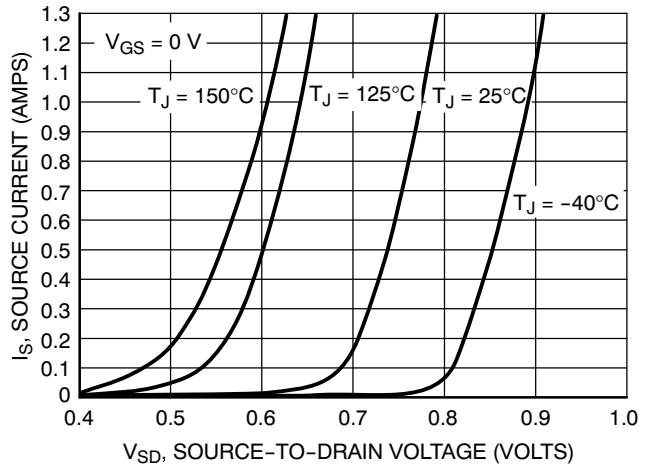
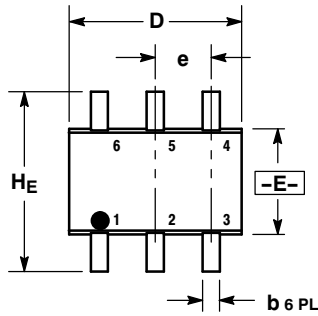

Figure 10. Diode Forward Voltage vs. Current

NTJS4160N

PACKAGE DIMENSIONS

SC-88 (SOT-363)
CASE 419B-02
ISSUE W



STYLE 28:
PIN 1. DRAIN
2. DRAIN
3. GATE
4. SOURCE
5. DRAIN
6. DRAIN

b 6 PL
⊕ 0.2 (0.008) M E M

- NOTES:
1. DIMENSIONING AND TOLERANCING PER ANSI Y14.5M, 1982.
2. CONTROLLING DIMENSION: INCH.
3. 419B-01 OBSOLETE, NEW STANDARD 419B-02.

DIM	MILLIMETERS			INCHES		
	MIN	NOM	MAX	MIN	NOM	MAX
A	0.80	0.95	1.10	0.031	0.037	0.043
A1	0.00	0.05	0.10	0.000	0.002	0.004
A3	0.20 REF			0.008 REF		
b	0.10	0.21	0.30	0.004	0.008	0.012
C	0.10	0.14	0.25	0.004	0.005	0.010
D	1.80	2.00	2.20	0.070	0.078	0.086
E	1.15	1.25	1.35	0.045	0.049	0.053
e	0.65 BSC			0.026 BSC		
L	0.10	0.20	0.30	0.004	0.008	0.012
HE	2.00	2.10	2.20	0.078	0.082	0.086

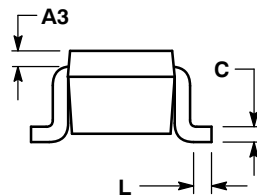
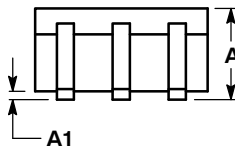

SOLDERING FOOTPRINT*

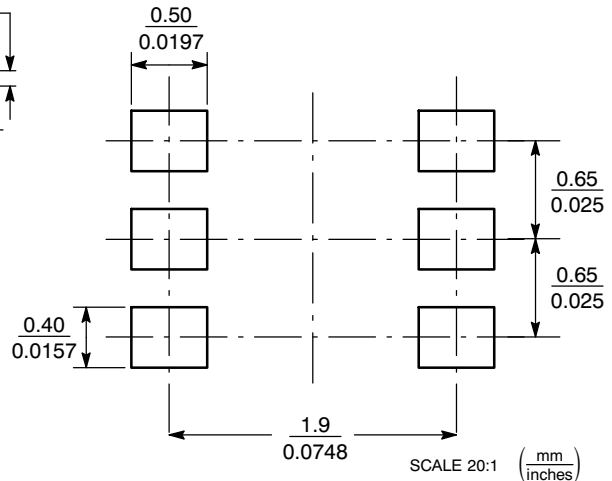

*For additional information on our Pb-Free strategy and soldering details, please download the ON Semiconductor Soldering and Mounting Techniques Reference Manual, SOLDERRM/D.

ON Semiconductor and are registered trademarks of Semiconductor Components Industries, LLC (SCILLC). SCILLC reserves the right to make changes without further notice to any products herein. SCILLC makes no warranty, representation or guarantee regarding the suitability of its products for any particular purpose, nor does SCILLC assume any liability arising out of the application or use of any product or circuit, and specifically disclaims any and all liability, including without limitation special, consequential or incidental damages. "Typical" parameters which may be provided in SCILLC data sheets and/or specifications can and do vary in different applications and actual performance may vary over time. All operating parameters, including "Typicals" must be validated for each customer application by customer's technical experts. SCILLC does not convey any license under its patent rights nor the rights of others. SCILLC products are not designed, intended, or authorized for use as components in systems intended for surgical implant into the body, or other applications intended to support or sustain life, or for any other application in which the failure of the SCILLC product could create a situation where personal injury or death may occur. Should Buyer purchase or use SCILLC products for any such unintended or unauthorized application, Buyer shall indemnify and hold SCILLC and its officers, employees, subsidiaries, affiliates, and distributors harmless against all claims, costs, damages, and expenses, and reasonable attorney fees arising out of, directly or indirectly, any claim of personal injury or death associated with such unintended or unauthorized use, even if such claim alleges that SCILLC was negligent regarding the design or manufacture of the part. SCILLC is an Equal Opportunity/Affirmative Action Employer. This literature is subject to all applicable copyright laws and is not for resale in any manner.

PUBLICATION ORDERING INFORMATION

LITERATURE FULFILLMENT:
Literature Distribution Center for ON Semiconductor
RD, Box 5163, Denver, Colorado 80217 USA
Phone: 303-675-2175 or 800-344-3860 Toll Free USA/Canada
Fax: 303-675-2176 or 800-344-3867 Toll Free USA/Canada
Email: orderlit@onsemi.com

N. American Technical Support: 800-282-9855 Toll Free
USA/Canada
Europe, Middle East and Africa Technical Support:
Phone: 421 33 790 2910
Japan Customer Focus Center
Phone: 81-3-5773-3850

ON Semiconductor Website: www.onsemi.com

Order Literature: <http://www.onsemi.com/orderlit>

For additional information, please contact your local Sales Representative

Mouser Electronics

Authorized Distributor

Click to View Pricing, Inventory, Delivery & Lifecycle Information:

[ON Semiconductor:](#)

[NTJS4160NT1G](#)