

# BD243B, BD243C (NPN), BD244B, BD244C (PNP)



ON Semiconductor®

[www.onsemi.com](http://www.onsemi.com)

## Complementary Silicon Plastic Power Transistors

These devices are designed for use in general purpose amplifier and switching applications.

### Features

- High Current Gain Bandwidth Product
- These Devices are Pb-Free and are RoHS Compliant\*

### MAXIMUM RATINGS

Rating	Symbol	Value	Unit
Collector-Emitter Voltage BD243B, BD244B BD243C, BD244C	$V_{CEO}$	80 100	Vdc
Collector-Base Voltage BD243B, BD244B BD243C, BD244C	$V_{CB}$	80 100	Vdc
Emitter-Base Voltage	$V_{EB}$	5.0	Vdc
Collector Current - Continuous	$I_C$	6	Adc
Collector Current - Peak	$I_{CM}$	10	Adc
Base Current	$I_B$	2.0	Adc
Total Device Dissipation @ $T_C = 25^\circ\text{C}$ Derate above $25^\circ\text{C}$	$P_D$	65 0.52	W W/ $^\circ\text{C}$
Operating and Storage Junction Temperature Range	$T_J, T_{stg}$	-65 to +150	$^\circ\text{C}$

Stresses exceeding those listed in the Maximum Ratings table may damage the device. If any of these limits are exceeded, device functionality should not be assumed, damage may occur and reliability may be affected.

### THERMAL CHARACTERISTICS

Characteristics	Symbol	Max	Unit
Thermal Resistance, Junction-to-Case	$R_{\theta JC}$	1.92	$^\circ\text{C}/\text{W}$

## 6 AMPERE POWER TRANSISTORS COMPLEMENTARY SILICON 80-100 VOLTS 65 WATTS

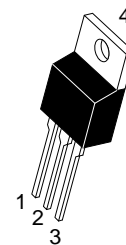
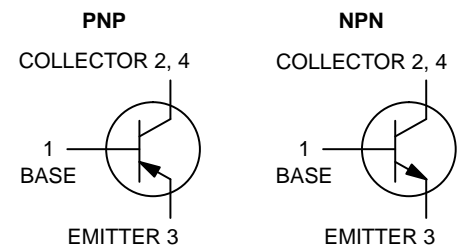

TO-220  
CASE 221A  
STYLE 1

### MARKING DIAGRAM



BD24xy = Device Code  
x = 3 or 4  
y = B or C  
A = Assembly Location  
Y = Year  
WW = Work Week  
G = Pb-Free Package

### ORDERING INFORMATION

Device	Package	Shipping
BD243BG	TO-220 (Pb-Free)	50 Units / Rail
BD243CG	TO-220 (Pb-Free)	50 Units / Rail
BD244BG	TO-220 (Pb-Free)	50 Units / Rail
BD244CG	TO-220 (Pb-Free)	50 Units / Rail

\*For additional information on our Pb-Free strategy and soldering details, please download the ON Semiconductor Soldering and Mounting Techniques Reference Manual, SOLDERRM/D.

## BD243B, BD243C (NPN), BD244B, BD244C (PNP)

### ELECTRICAL CHARACTERISTICS ( $T_C = 25^\circ\text{C}$ unless otherwise noted)

Characteristic	Symbol	Min	Max	Unit
Collector–Emitter Sustaining Voltage (Note 1) ( $I_C = 30\text{ mAdc}$ , $I_B = 0$ ) BD243B, BD244B BD243C, BD244C	$V_{CEO(sus)}$	80 100	– –	Vdc
Collector Cutoff Current ( $V_{CE} = 60\text{ Vdc}$ , $I_B = 0$ ) BD243B, BD243C, BD244B, BD244C	$I_{CEO}$	–	0.7	mAdc
Collector Cutoff Current ( $V_{CE} = 80\text{ Vdc}$ , $V_{EB} = 0$ ) BD243B, BD244B ( $V_{CE} = 100\text{ Vdc}$ , $V_{EB} = 0$ ) BD243C, BD244C	$I_{CES}$	– –	400 400	$\mu\text{Adc}$
Emitter Cutoff Current ( $V_{BE} = 5.0\text{ Vdc}$ , $I_C = 0$ )	$I_{EBO}$	–	1.0	mAdc

### ON CHARACTERISTICS (Note 1)

DC Current Gain ( $I_C = 0.3\text{ Adc}$ , $V_{CE} = 4.0\text{ Vdc}$ ) ( $I_C = 3.0\text{ Adc}$ , $V_{CE} = 4.0\text{ Vdc}$ )	$h_{FE}$	30 15	– –	–
Collector–Emitter Saturation Voltage ( $I_C = 6.0\text{ Adc}$ , $I_B = 1.0\text{ Adc}$ )	$V_{CE(sat)}$	–	1.5	Vdc
Base–Emitter On Voltage ( $I_C = 6.0\text{ Adc}$ , $V_{CE} = 4.0\text{ Vdc}$ )	$V_{BE(on)}$	–	2.0	Vdc

### DYNAMIC CHARACTERISTICS

Current–Gain – Bandwidth Product (Note 2) ( $I_C = 500\text{ mAdc}$ , $V_{CE} = 10\text{ Vdc}$ , $f_{test} = 1.0\text{ MHz}$ )	$f_T$	3.0	–	MHz
Small–Signal Current Gain ( $I_C = 0.5\text{ Adc}$ , $V_{CE} = 10\text{ Vdc}$ , $f = 1.0\text{ kHz}$ )	$h_{fe}$	20	–	–

Product parametric performance is indicated in the Electrical Characteristics for the listed test conditions, unless otherwise noted. Product performance may not be indicated by the Electrical Characteristics if operated under different conditions.

1. Pulse Test: Pulsewidth  $\leq 300\ \mu\text{s}$ , Duty Cycle  $\leq 2.0\%$ .
2.  $f_T = h_{fe} \cdot f_{test}$

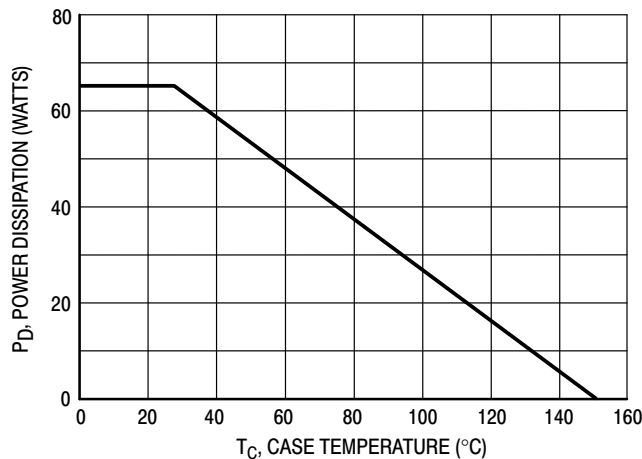

**Figure 1. Power Derating**

# BD243B, BD243C (NPN), BD244B, BD244C (PNP)

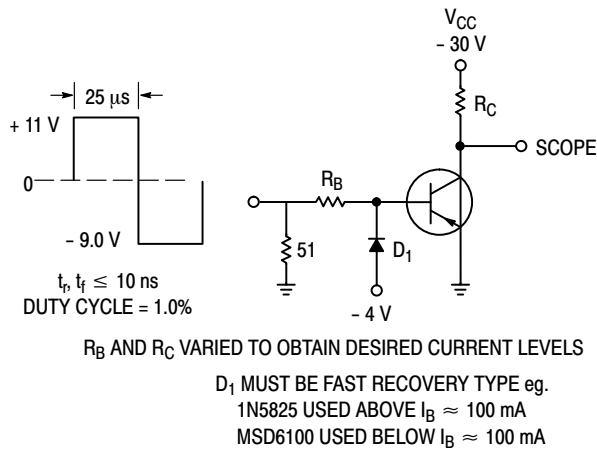

Figure 2. Switching Time Test Circuit

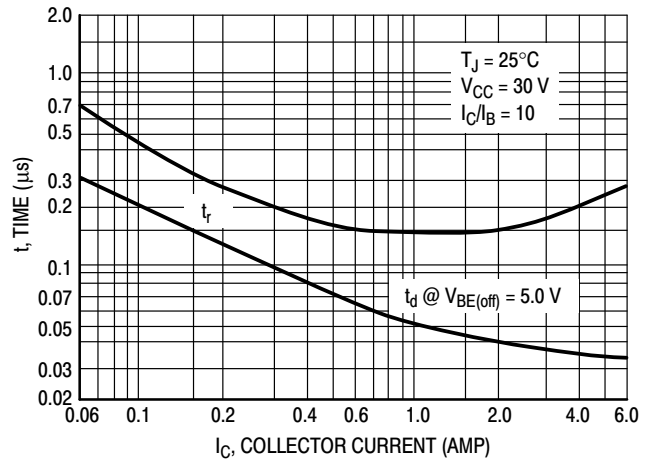

Figure 3. Turn-On Time

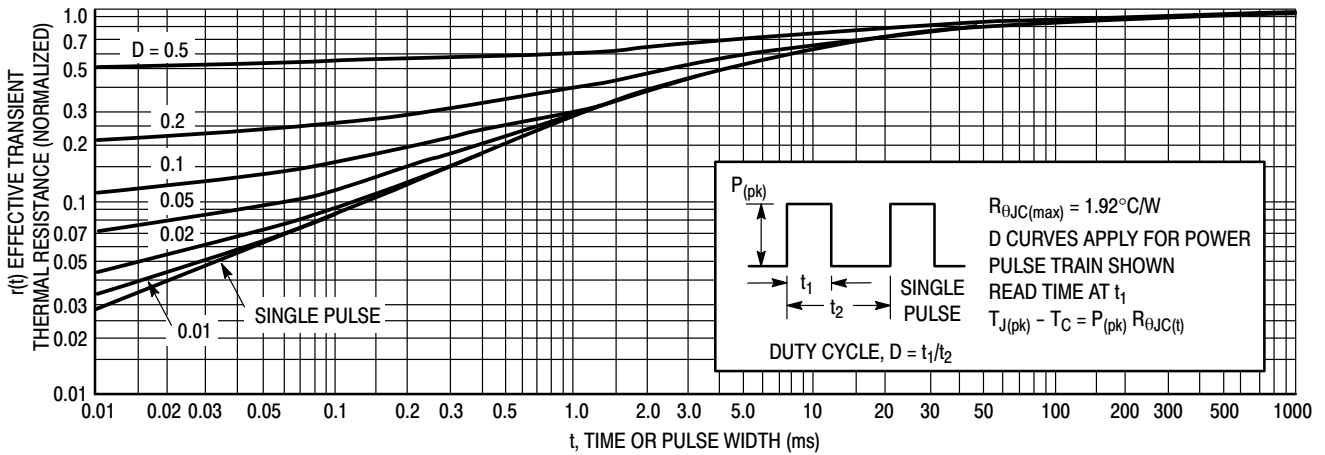

Figure 4. Thermal Response

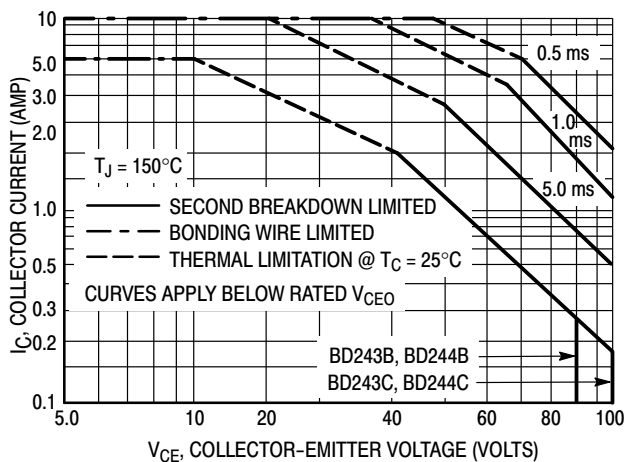
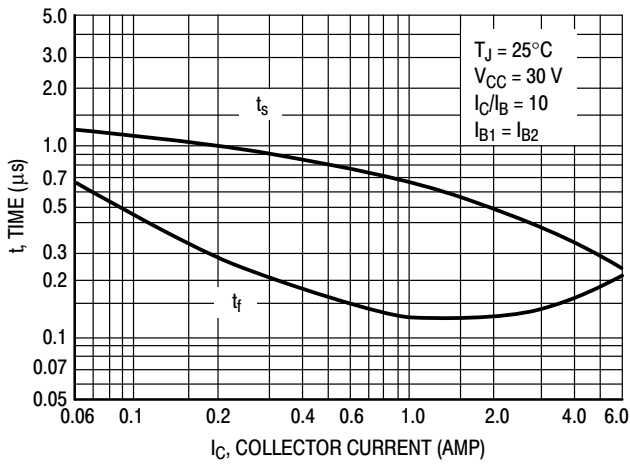

Figure 5. Active Region Safe Operating Area

There are two limitations on the power handling ability of a transistor: average junction temperature and second breakdown. Safe operating area curves indicate  $I_C - V_{CE}$  limits of the transistor that must be observed for reliable operation, i.e., the transistor must not be subjected to greater dissipation than the curves indicate.

The data of Figure 5 is based on  $T_{J(pk)} = 150^\circ\text{C}$ :  $T_C$  is variable depending on conditions. Second breakdown pulse limits are valid for duty cycles to 10% provided  $T_{J(pk)} \leq 150^\circ\text{C}$ ,  $T_{J(pk)}$  may be calculated from the data in Figure 4. At high case temperatures, thermal limitations will reduce the power that can be handled to values less than the limitations imposed by second breakdown.

# BD243B, BD243C (NPN), BD244B, BD244C (PNP)



**Figure 6. Turn-Off Time**

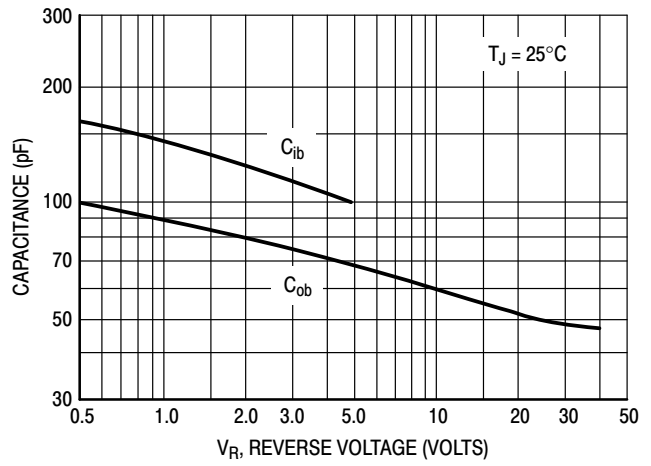

**Figure 7. Capacitance**

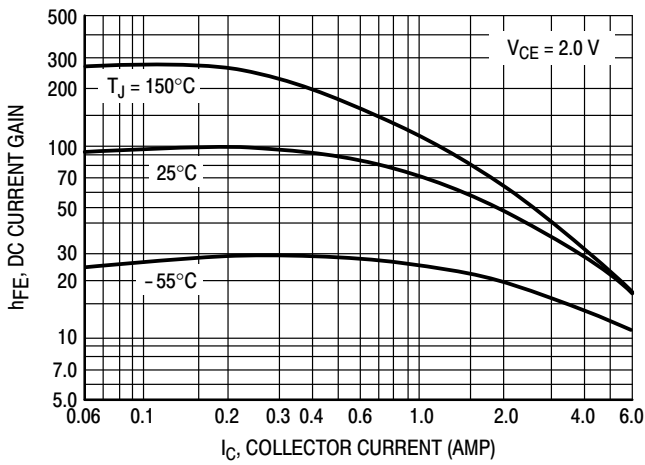

**Figure 8. DC Current Gain**

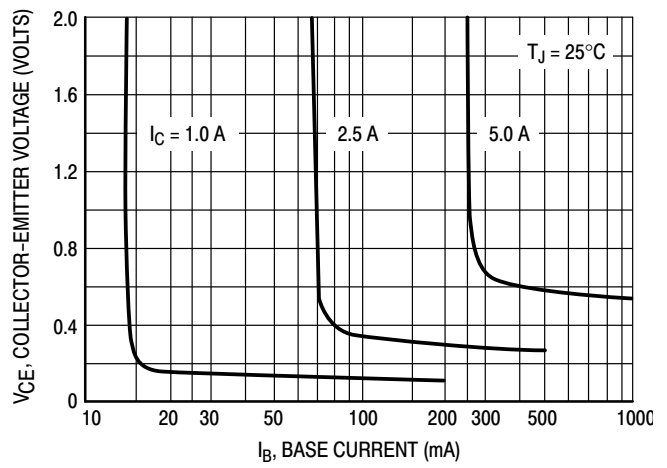

**Figure 9. Collector Saturation Region**



**Figure 10. "On" Voltages**

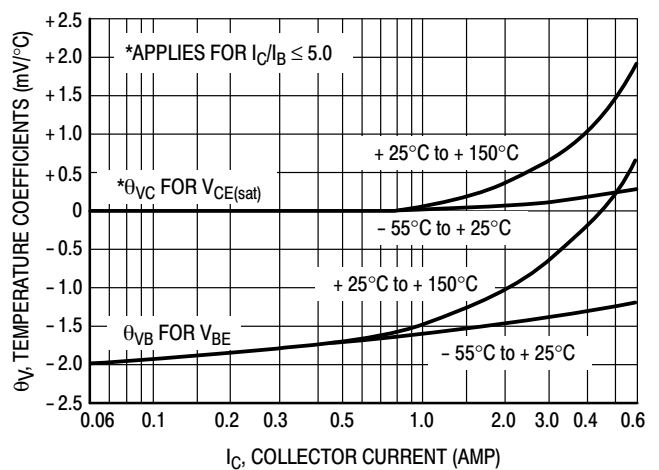
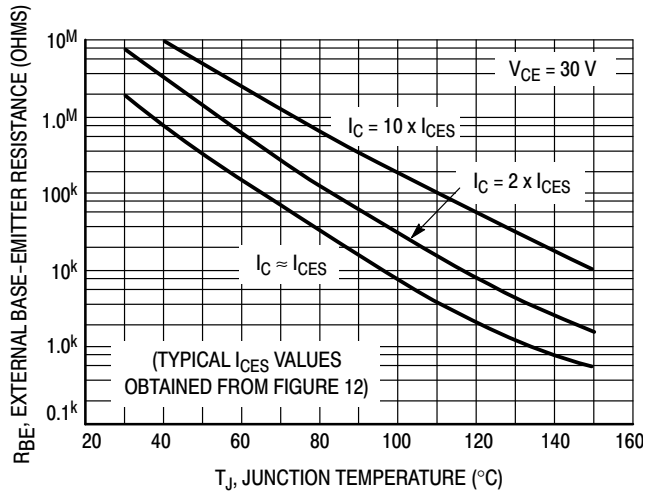

**Figure 11. Temperature Coefficients**

**BD243B, BD243C (NPN), BD244B, BD244C (PNP)**



**Figure 12. Collector Cut-Off Region**



**Figure 13. Effects of Base-Emitter Resistance**

# BD243B, BD243C (NPN), BD244B, BD244C (PNP)

## PACKAGE DIMENSIONS

TO-220  
CASE 221A-09  
ISSUE AH



**NOTES:**

1. DIMENSIONING AND TOLERANCING PER ANSI Y14.5M, 1982.
2. CONTROLLING DIMENSION: INCH.
3. DIMENSION Z DEFINES A ZONE WHERE ALL BODY AND LEAD IRREGULARITIES ARE ALLOWED.

DIM	INCHES		MILLIMETERS	
	MIN	MAX	MIN	MAX
A	0.570	0.620	14.48	15.75
B	0.380	0.415	9.66	10.53
C	0.160	0.190	4.07	4.83
D	0.025	0.038	0.64	0.96
F	0.142	0.161	3.61	4.09
G	0.095	0.105	2.42	2.66
H	0.110	0.161	2.80	4.10
J	0.014	0.024	0.36	0.61
K	0.500	0.562	12.70	14.27
L	0.045	0.060	1.15	1.52
N	0.190	0.210	4.83	5.33
Q	0.100	0.120	2.54	3.04
R	0.080	0.110	2.04	2.79
S	0.045	0.055	1.15	1.39
T	0.235	0.255	5.97	6.47
U	0.000	0.050	0.00	1.27
V	0.045	---	1.15	---
Z	---	0.080	---	2.04

**STYLE 1:**

1. BASE
2. COLLECTOR
3. EMITTER
4. COLLECTOR

ON Semiconductor and the  are registered trademarks of Semiconductor Components Industries, LLC (SCILLC) or its subsidiaries in the United States and/or other countries. SCILLC owns the rights to a number of patents, trademarks, copyrights, trade secrets, and other intellectual property. A listing of SCILLC's product/patent coverage may be accessed at [www.onsemi.com/site/pdf/Patent-Marking.pdf](http://www.onsemi.com/site/pdf/Patent-Marking.pdf). SCILLC reserves the right to make changes without further notice to any products herein. SCILLC makes no warranty, representation or guarantee regarding the suitability of its products for any particular purpose, nor does SCILLC assume any liability arising out of the application or use of any product or circuit, and specifically disclaims any and all liability, including without limitation special, consequential or incidental damages. "Typical" parameters which may be provided in SCILLC data sheets and/or specifications can and do vary in different applications and actual performance may vary over time. All operating parameters, including "Typicals" must be validated for each customer application by customer's technical experts. SCILLC does not convey any license under its patent rights nor the rights of others. SCILLC products are not designed, intended, or authorized for use as components in systems intended for surgical implant into the body, or other applications intended to support or sustain life, or for any other application in which the failure of the SCILLC product could create a situation where personal injury or death may occur. Should Buyer purchase or use SCILLC products for any such unintended or unauthorized application, Buyer shall indemnify and hold SCILLC and its officers, employees, subsidiaries, affiliates, and distributors harmless against all claims, costs, damages, and expenses, and reasonable attorney fees arising out of, directly or indirectly, any claim of personal injury or death associated with such unintended or unauthorized use, even if such claim alleges that SCILLC was negligent regarding the design or manufacture of the part. SCILLC is an Equal Opportunity/Affirmative Action Employer. This literature is subject to all applicable copyright laws and is not for resale in any manner.

### PUBLICATION ORDERING INFORMATION

**LITERATURE FULFILLMENT:**

Literature Distribution Center for ON Semiconductor  
P.O. Box 5163, Denver, Colorado 80217 USA  
Phone: 303-675-2175 or 800-344-3860 Toll Free USA/Canada  
Fax: 303-675-2176 or 800-344-3867 Toll Free USA/Canada  
Email: [orderlit@onsemi.com](mailto:orderlit@onsemi.com)

**N. American Technical Support:** 800-282-9855 Toll Free  
USA/Canada  
**Europe, Middle East and Africa Technical Support:**  
Phone: 421 33 790 2910  
**Japan Customer Focus Center**  
Phone: 81-3-5817-1050

**ON Semiconductor Website:** [www.onsemi.com](http://www.onsemi.com)

**Order Literature:** <http://www.onsemi.com/orderlit>

For additional information, please contact your local Sales Representative