

> **Features**

- High Speed Switching
- Low On-Resistance
- No Secondary Breakdown
- Low Driving Power
- High Voltage
- $V_{GS} = \pm 30V$ Guarantee
- Avalanche Proof

> **Applications**

- Switching Regulators
- UPS
- DC-DC converters
- General Purpose Power Amplifier

> **Outline Drawing**

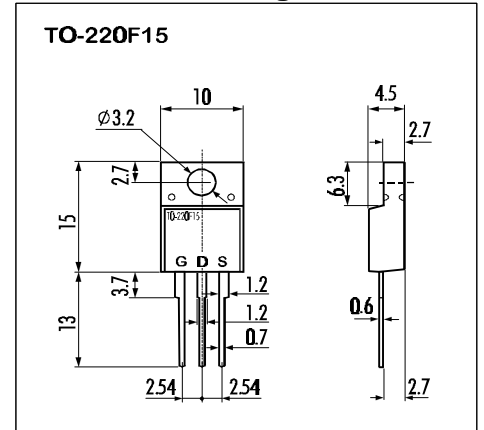

> **Maximum Ratings and Characteristics**

- Absolute Maximum Ratings ($T_C=25^\circ C$), unless otherwise specified

Item	Symbol	Rating	Unit
Drain-Source-Voltage	V_{DS}	250	V
Drain-Gate-Voltage($R_{GS}=20K\Omega$)	V_{DGR}	250	V
Continous Drain Current	I_D	18	A
Pulsed Drain Current	$I_{D(puls)}$	72	A
Gate-Source-Voltage	V_{GS}	± 30	V
Max. Power Dissipation	P_D	50	W
Operating and Storage Temperature Range	T_{ch}	150	$^\circ C$
	T_{stg}	-55 ~ +150	$^\circ C$

> **Equivalent Circuit**

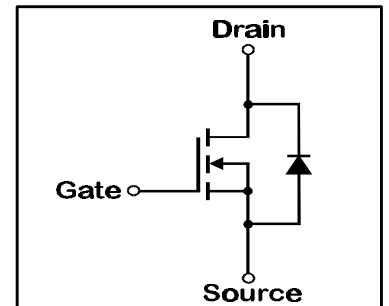

- Electrical Characteristics ($T_C=25^\circ C$), unless otherwise specified

Item	Symbol	Test conditions	Min.	Typ.	Max.	Unit
Drain-Source Breakdown-Voltage	$V_{(BR)DSS}$	$I_D=1mA$ $V_{GS}=0V$	250			V
Gate Threshold Voltage	$V_{GS(th)}$	$I_D=1mA$ $V_{DS}=V_{GS}$	2,5	3,0	3,5	V
Zero Gate Voltage Drain Current	I_{DSS}	$V_{DS}=250V$ $T_{ch}=25^\circ C$		10	500	μA
		$V_{GS}=0V$ $T_{ch}=125^\circ C$		0,2	1,0	mA
Gate Source Leakage Current	I_{GSS}	$V_{GS}=\pm 30V$ $V_{DS}=0V$		10	100	nA
Drain Source On-State Resistance	$R_{DS(on)}$	$I_D=9A$ $V_{GS}=10V$		0,13	0,18	Ω
Forward Transconductance	g_{fs}	$I_D=9A$ $V_{DS}=25V$	7	14		S
Input Capacitance	C_{iss}	$V_{DS}=25V$		1750	2650	pF
Output Capacitance	C_{oss}	$V_{GS}=0V$		290	440	pF
Reverse Transfer Capacitance	C_{rss}	$f=1MHz$		65	100	pF
Turn-On-Time t_{on} ($t_{on}=t_{d(on)}+t_r$)	$t_{d(on)}$	$V_{CC}=150V$		30	45	ns
		$I_D=18A$		50	75	ns
Turn-Off-Time t_{off} ($t_{off}=t_{d(off)}+t_f$)	$t_{d(off)}$	$V_{GS}=10V$		80	120	ns
		$R_{GS}=10\Omega$		70	110	ns
Avalanche Capability	I_{AV}	$L=100\mu H$ $T_{ch}=25^\circ C$	18			A
Continous Reverse Drain Current	I_{DR}				18	A
Pulsed Reverse Drain Current	I_{DRM}				72	A
Diode Forward On-Voltage	V_{SD}	$I_F=2I_{DR}$ $V_{GS}=0V$ $T_{ch}=25^\circ C$		1	1,5	V
Reverse Recovery Time	t_{rr}	$I_F=I_{DR}$ $V_{GS}=0V$		150		ns
Reverse Recovery Charge	Q_{rr}	$-dI_F/dt=100A/\mu s$ $T_{ch}=25^\circ C$		1		μC

- Thermal Characteristics

Item	Symbol	Test conditions	Min.	Typ.	Max.	Unit
Thermal Resistance	$R_{th(ch-a)}$	channel to air			62,5	$^\circ C/W$
	$R_{th(ch-c)}$	channel to case			2,5	$^\circ C/W$

N-channel MOS-FET			
250V	0,18Ω	18A	50W

2SK2255-01MR

FAP-IIA Series



> Characteristics

Typical Output Characteristics

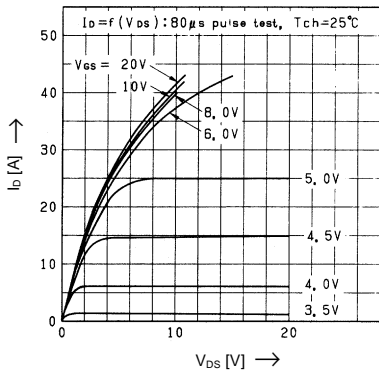

Drain-Source-On-State Resistance vs. T_{ch}

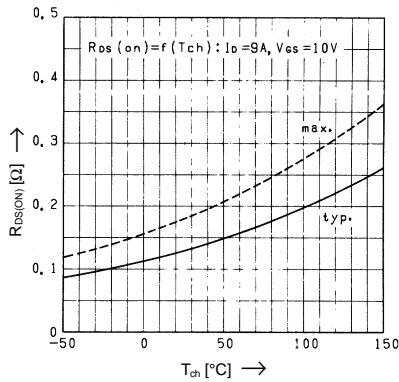

Typical Transfer Characteristics

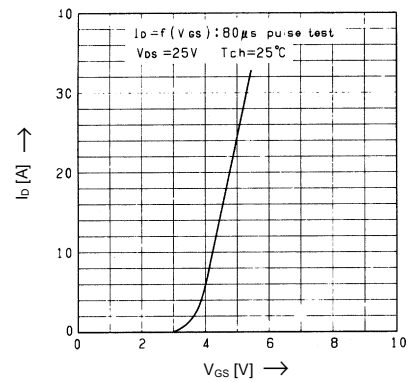

Typical Drain-Source-On-State-Resistance vs. I_D

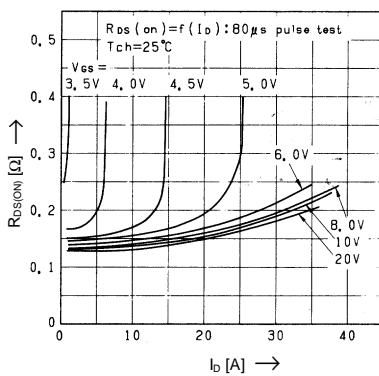

Typical Forward Transconductance vs. I_D

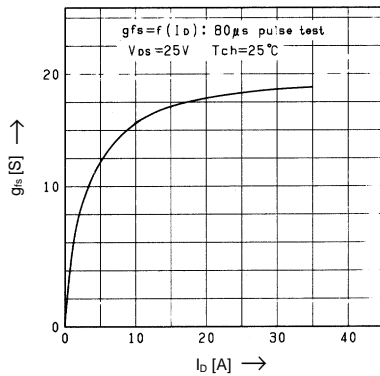

Gate Threshold Voltage vs. T_{ch}

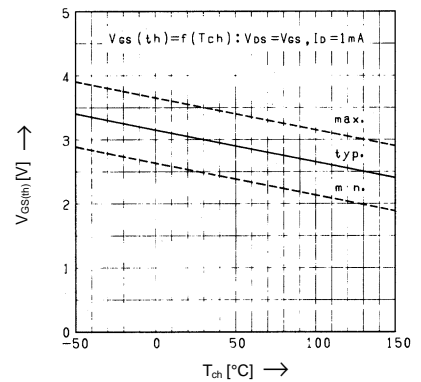

Typical Capacitance vs. V_{DS}

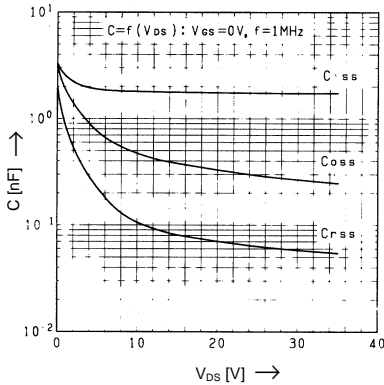

Typical Input Charge

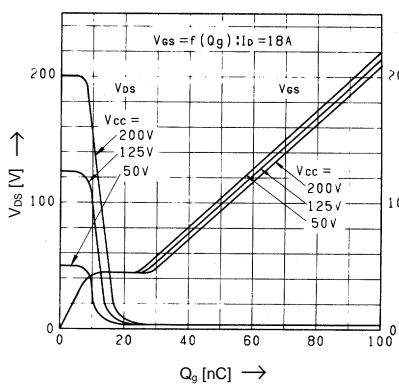

Forward Characteristics of Reverse Diode

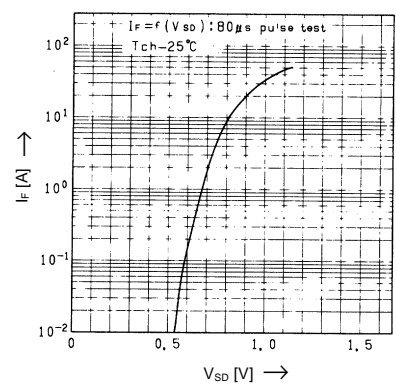

Allowable Power Dissipation vs. T_C

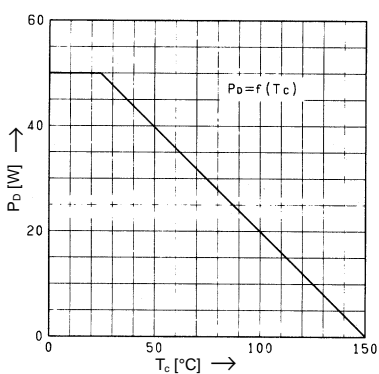

Safe operation area

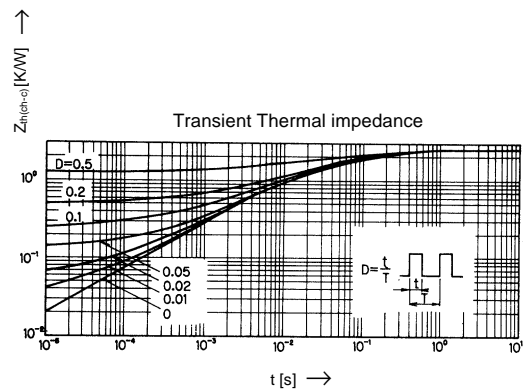
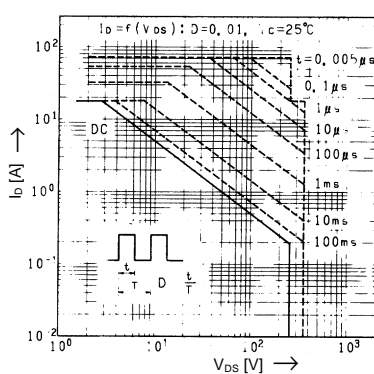

This datasheet has been download from:

www.datasheetcatalog.com

Datasheets for electronics components.