

# Darlington

# 2SB1647

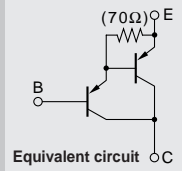

**Silicon PNP Epitaxial Planar Transistor (Complement to type 2SD2560)**

**Application : Audio, Series Regulator and General Purpose**

**Absolute maximum ratings (Ta=25°C)**

Symbol	Ratings	Unit
V <sub>CB0</sub>	-150	V
V <sub>CE0</sub>	-150	V
V <sub>EB0</sub>	-5	V
I <sub>C</sub>	-15	A
I <sub>B</sub>	-1	A
P <sub>C</sub>	130(T <sub>C</sub> =25°C)	W
T <sub>j</sub>	150	°C
T <sub>stg</sub>	-55 to +150	°C

**Electrical Characteristics (Ta=25°C)**

Symbol	Conditions	Ratings	Unit
I <sub>CB0</sub>	V <sub>CB</sub> =-150V	-100max	μA
I <sub>EB0</sub>	V <sub>EB</sub> =-5V	-100max	μA
V <sub>(BR)CEO</sub>	I <sub>C</sub> =-30mA	-150min	V
h <sub>FE</sub>	V <sub>CE</sub> =-4V, I <sub>C</sub> =-10A	5000min*	
V <sub>CE(sat)</sub>	I <sub>C</sub> =-10A, I <sub>B</sub> =-10mA	-2.5max	V
V <sub>BE(sat)</sub>	I <sub>C</sub> =-10A, I <sub>B</sub> =-10mA	-3.0max	V
f <sub>T</sub>	V <sub>CE</sub> =-12V, I <sub>E</sub> =2A	45typ	MHz
C <sub>OB</sub>	V <sub>CB</sub> =-10V, f=1MHz	320typ	pF

\*h<sub>FE</sub> Rank O(5000to12000), P(6500to20000), Y(15000to30000)

**Typical Switching Characteristics (Common Emitter)**

V <sub>CC</sub> (V)	R <sub>L</sub> (Ω)	I <sub>C</sub> (A)	V <sub>BB1</sub> (V)	V <sub>BB2</sub> (V)	I <sub>B1</sub> (mA)	I <sub>B2</sub> (mA)	t <sub>on</sub> (μs)	t <sub>stg</sub> (μs)	t <sub>f</sub> (μs)
-40	4	10	-10	5	-10	10	0.7typ	1.6typ	1.1typ

**External Dimensions MT-100(TO3P)**

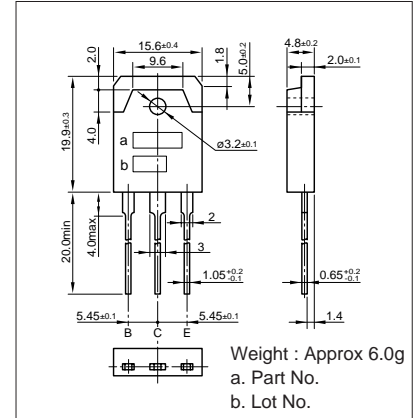

**I<sub>C</sub>-V<sub>CE</sub> Characteristics (Typical)**

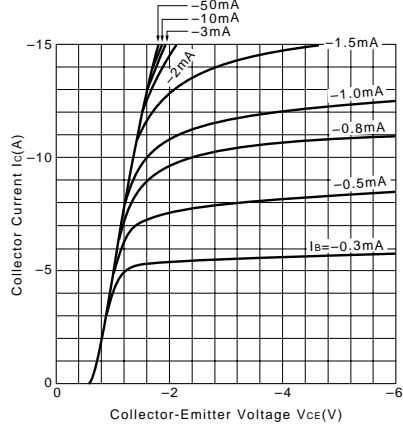

**V<sub>CE(sat)</sub>-I<sub>B</sub> Characteristics (Typical)**

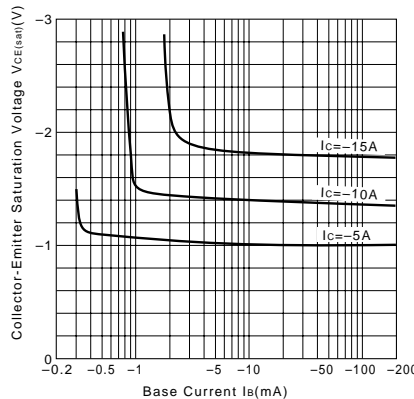

**I<sub>C</sub>-V<sub>BE</sub> Temperature Characteristics (Typical)**

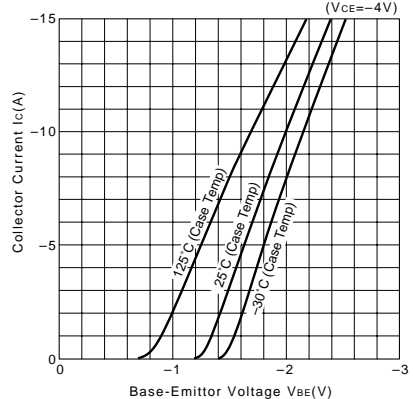

**h<sub>FE</sub>-I<sub>C</sub> Characteristics (Typical)**

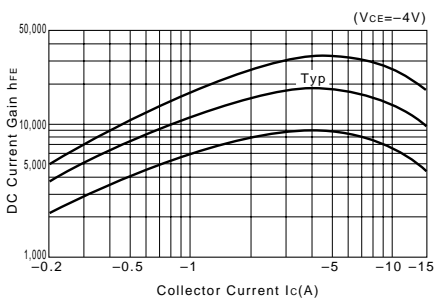

**h<sub>FE</sub>-I<sub>C</sub> Temperature Characteristics (Typical)**

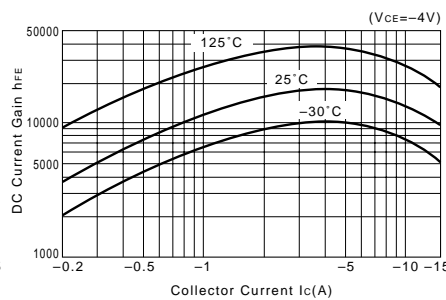

**θ<sub>j-a</sub>-t Characteristics**

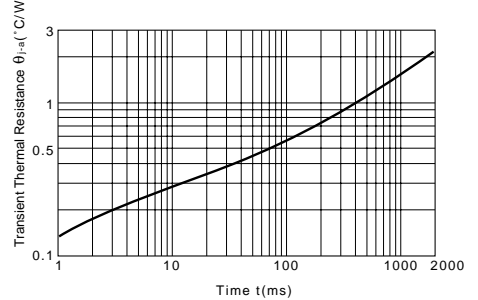

**f<sub>T</sub>-I<sub>E</sub> Characteristics (Typical)**

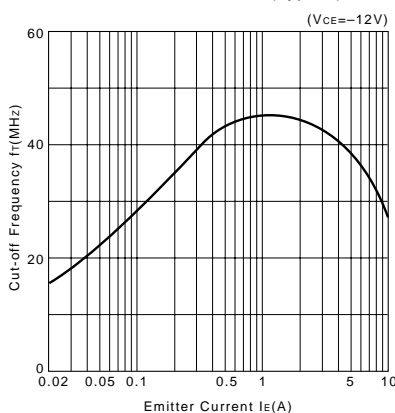

**Safe Operating Area (Single Pulse)**

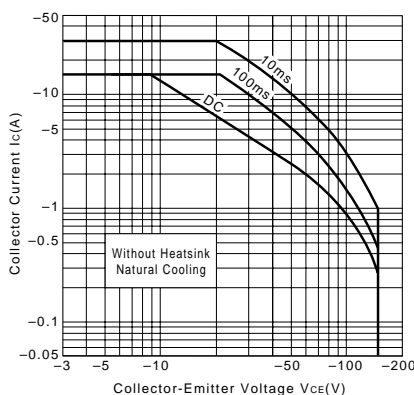

**P<sub>C</sub>-T<sub>a</sub> Derating**

