

DESCRIPTION

The PT7313E is an audio processor designed for versatile application, including 3 stereo input selectors with adjustable gain, master volume control with low frequency loudness compensation, individual output attenuator and tone control. It is a good solution for the car audio signal processing.

Due to the high reliability requirement from the car audio business, the PT7313E improves both audio performance and input surge current capability that make PT7313E the best solution for the cost-effective car audio systems.

FEATURES

- 3 stereo inputs with gain selection, range from 0dB to +11.25dB in 3.75dB/step
- Master volume from 0 dB to -78.75dB in 1.25dB/step
- Speaker attenuator for balance and fader, range from 0dB to -38.75dB in 1.25dB/step
- Each channel output can be muted individually.
- Low frequency loudness compensation
- Bass and Treble control, range from -14dB to +14dB in 2dB/step
- Wide operation range (VDD = 4V to 10V)

APPLICATIONS

- Car Audio
- Home Audio System
- Powered Speaker System

APPLICATION CIRCUIT

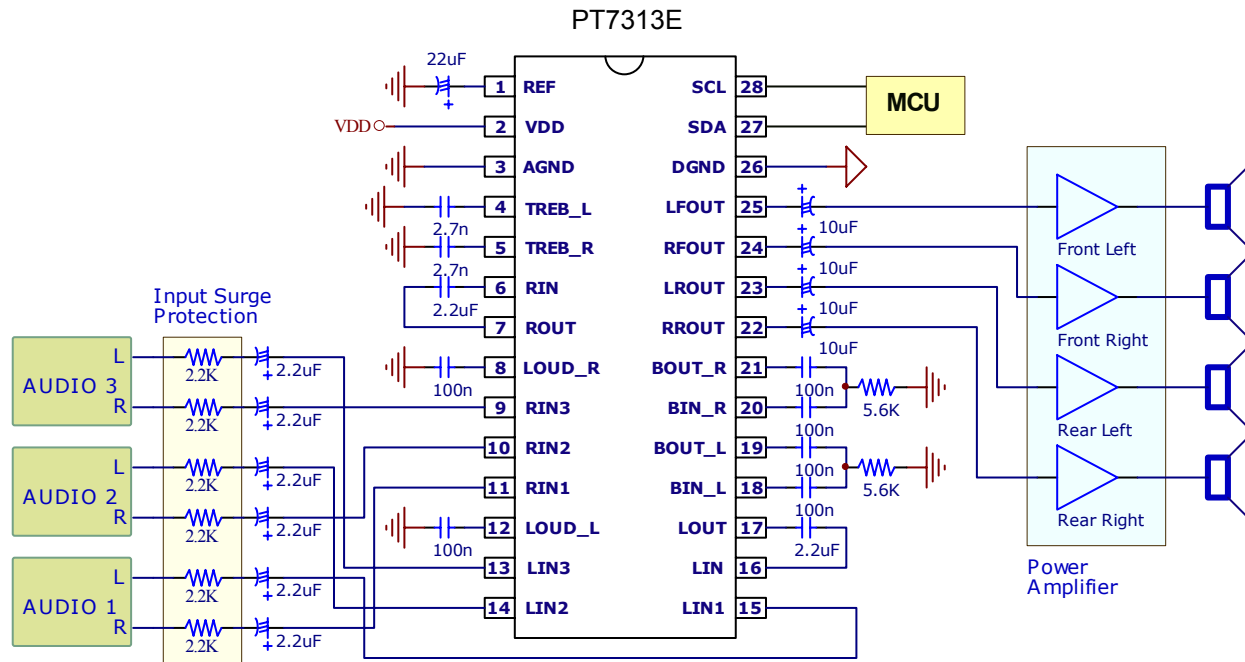

BLOCK DIAGRAM

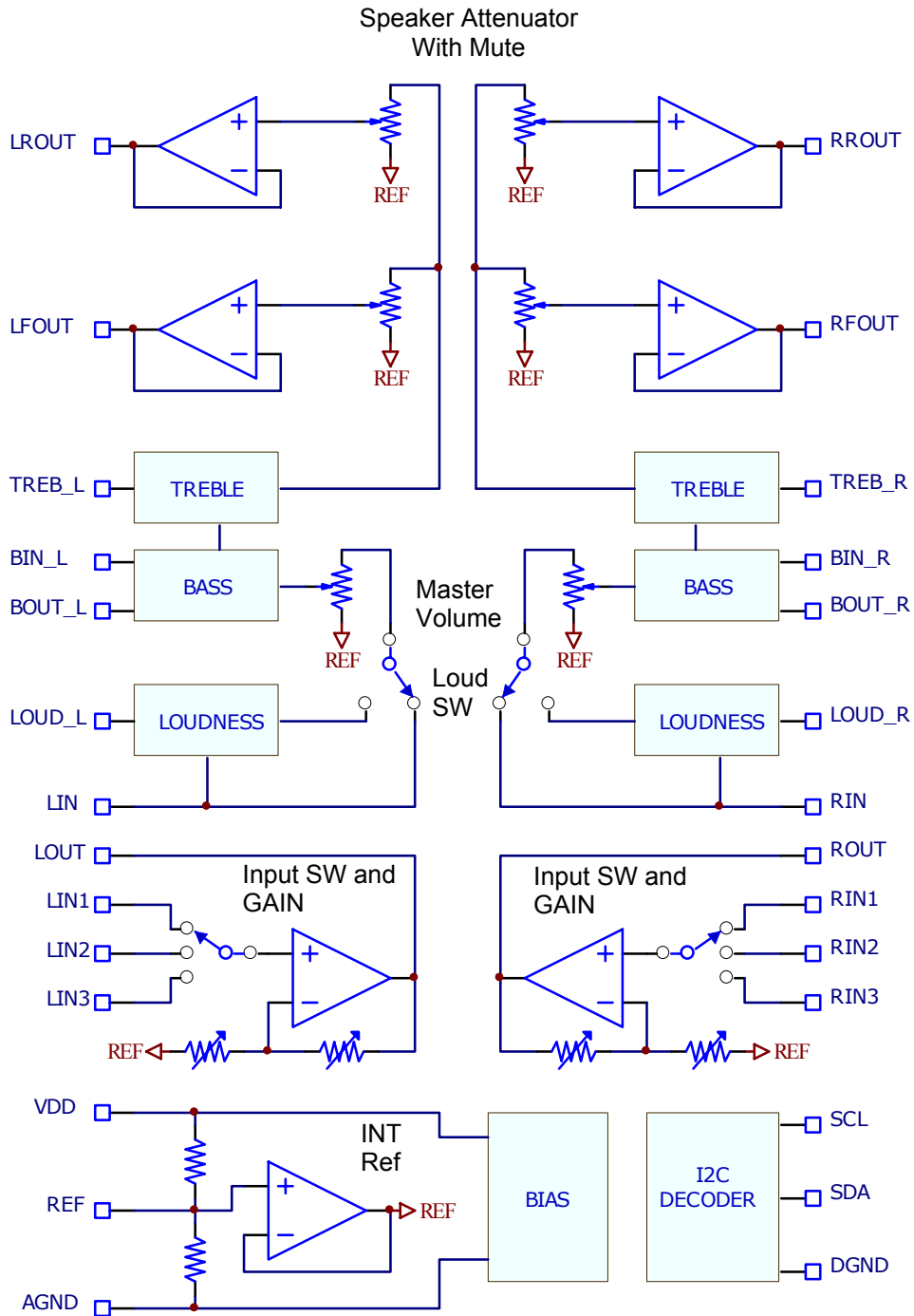

ORDER INFORMATION

Valid Part Number	Package Type	Top Code
PT7313E-S	28 Pins, SOP, 300mil	PT7313E

PIN CONFIGURATION

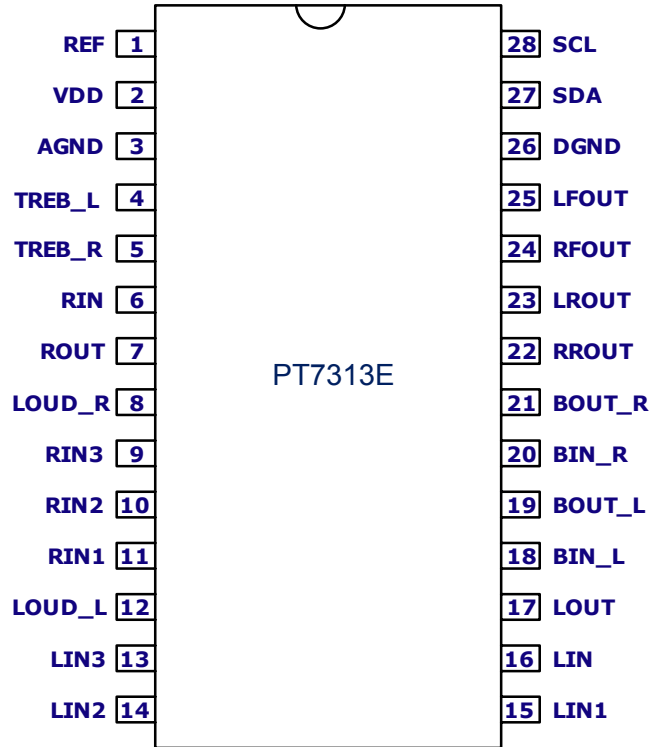



PIN DESCRIPTION

Pin Name	I/O	Description	Pin No.
REF	-	Analog reference voltage (1/2VDD)	1
VDD	-	Supply input voltage	2
AGND	-	Analog ground	3
TREB_L	I	Left channel input for treble controller	4
TREB_R	I	Right channel input for treble controller	5
RIN	I	Right channel volume controller input	6
ROUT	O	Right channel Input selector output	7
LOUD_R	I	Right channel loudness input	8
RIN3	I	Right channel input 3	9
RIN2	I	Right channel input 2	10
RIN1	I	Right channel input 1	11
LOUD_L	I	Left channel loudness input	12
LIN3	I	Left channel input 3	13
LIN2	I	Left channel input 2	14
LIN1	I	Left channel input 1	15
LIN	I	Left channel volume controller input	16
LOUT	O	Left channel Input selector output	17
BIN_L	I	Left channel input for bass controller	18
BOUT_L	O	Left channel output for bass controller	19
BIN_R	I	Right channel input for bass controller	20
BOUT_R	O	Right channel output for bass controller	21
RROUT	O	Right rear speaker output	22
LROUT	O	Left rear speaker output	23
RFOUT	O	Right front speaker output	24
LFOUT	O	Left front speaker output	25
DGND	-	Digital ground	26
SDA	I	I ² C data input	27
SCL	I	I ² C clock input	28

CONTROL BUS SPECIFICATION

BUS INTERFACE

All functions of the PT7313E are controlled by the I²C interface, the interface is consisting by SDA and SCL pins. Detail protocol of the I²C bus will discuss on the next section. It should be noted that the bus level pull-up resistors connected to the PT7313E positive supply voltage may required in some application especially the MCU output high level is no enough.

DATA VALIDITY

A data on the SDA Line is considered valid and stable only when the SCL Signal is in HIGH State. The HIGH and LOW State of the SDA Line can only change when the SCL signal is LOW. Please refer to the figure below.

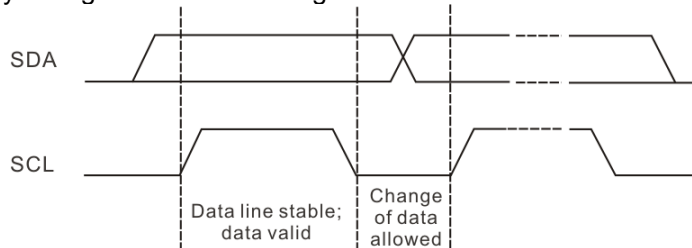

START AND STOP CONDITIONS

A Start Condition is activated when

- 1) The SCL is set to HIGH and
- 2) SDA shifts from HIGH to LOW State.

The Stop Condition is activated when

- 1) SCL is set to HIGH and
- 2) SDA shifts from LOW to HIGH State. Please refer to the timing diagram below..

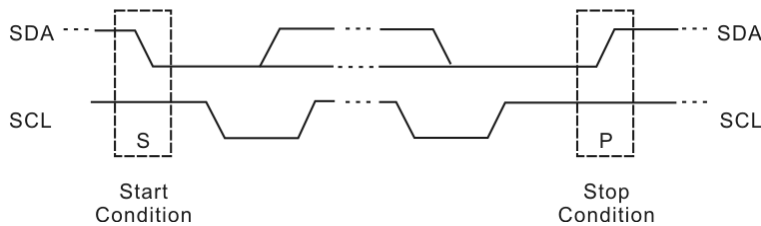

BYTE FORMAT

Every byte transmitted to the SDA Line consists of 8 bits. Each byte must be followed by an Acknowledge Bit. The MSB is first transmitted.

DATA BYTES

MSB							LSB	Function
0	0	B2	B1	B0	A2	A1	A0	Master Volume
1	1	0	B1	B0	A2	A1	A0	Speaker ATT LR
1	1	1	B1	B0	A2	A1	A0	Speaker ATT RR
1	0	0	B1	B0	A2	A1	A0	Speaker ATT LF
1	0	1	B1	B0	A2	A1	A0	Speaker ATT RF
0	1	0	G1	G0	LD	S1	S0	Input Switch and Gain
0	1	1	0	C3	C2	C1	C0	Bass Control
0	1	1	1	C3	C2	C1	C0	Treble Control

DATA RATE

The PT7313E support Standard-Mode (100kbit/s) I²C data rate In all operation condition, in specified condition it also support Fast-Mode (400kbit/s) I²C data rate, please refer to the follow table:

MCU Level	PT7313E VDD Voltage						
	4V	5V	6V	7V	8V	9V	10V
2.5V	F	F	x	x	x	x	x
3.3V	F	F	F	F	S	S	x
5V	x	F	F	F	F	F	F

Notes:

1. x = Not allow in this combination; S = Standard Mode Supported, F = Fast Mode Supported.
2. Data rate specification is design guarantee only, not fully tested in every combination.

I²C BUS INITIAL TIME

The PT7313E is controlled by the I²C bus command; each time the supply voltage applied to chip it needs an initial time to reset all of the internal decoder register, in this period access the I²C bus is prohibited. The initial time is determinate by capacitance it attached on REF pin (CREF) and Td. For proper operation USER must check the I²C starts timing is fit this requirement and recommended Td timing shown on next page is 50mS.

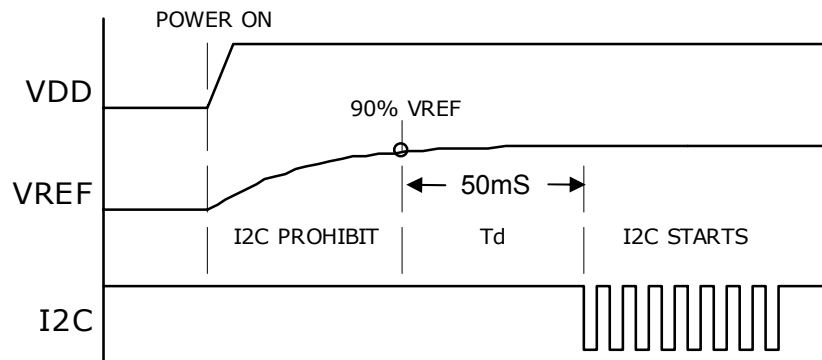

FUNCTION DESCRIPTION

MASTER VOLUME

The table below gives a detailed description of the Master Volume Data Bytes. For example, a volume of -37.5dB is given by 0 0 0 1 1 1 1 0.

MSB							LSB		Function
0	0	B2	B1	B0	A2	A1	A0	1.25dB/step	
					0	0	0	0	
					0	0	1	-1.25	
					0	1	0	-2.5	
					0	1	1	-3.75	
					1	0	0	-5	
					1	0	1	-6.25	
					1	1	0	-7.5	
					1	1	1	-8.75	
0	0	B2	B1	B0	A2	A1	A0	10dB/step	
		0	0	0				0	
		0	0	1				-10	
		0	1	0				-20	
		0	1	1				-30	
		1	0	0				-40	
		1	0	1				-50	
		1	1	0				-60	
		1	1	1				-70	

SPEAKER ATTENUATORS

The speaker attenuator in most of car audio system is performs balance and fader function, the table below gives a detailed description of the speaker attenuators data bytes. Total control range of the speaker attenuator is from 0dB to -37.5dB.

Example 1, an attenuation gain of -6.25dB on the Speaker Right Rear channel is combined 0dB and -6.25dB, therefore it should be given by: 1 1 1 0 0 1 0 1.

Example 2, an attenuation gain of -32.5dB on the Speaker Left Front channel is combined -30dB and -2.5dB, therefore it should be given by: 1 0 0 1 1 0 1 0.

MSB							LSB		Function
1	0	0	B1	B0	A2	A1	A0	Speaker LF	
1	0	1	B1	B0	A2	A1	A0	Speaker RF	
1	1	0	B1	B0	A2	A1	A0	Speaker LR	
1	1	1	B1	B0	A2	A1	A0	Speaker RR	
					0	0	0	0	
					0	0	1	-1.25	
					0	1	0	-2.5	
					0	1	1	-3.75	
					1	0	0	-5	
					1	0	1	-6.25	
					1	1	0	-7.5	
					1	1	1	-8.75	
		0	0					0	
		0	1					-10	
		1	0					-20	
		1	1					-30	
		1	1	1	1	1		Mute	

INPUT SELECTOR

The PT7313E provides 3 stereo input selector and following table shows the definition of the correspond register. The LD register is determinate the loudness function is ON or OFF, and G0 and G1 determinate the input gain of the selector output, this function is use to matching level of different sources to avoid overall volume difference.

MSB						LSB		Function
0	1	0	G1	G0	LD	S1	S0	Audio switch
						0	0	Stereo 1
						0	1	Stereo 2
						1	0	Stereo 3
					0			Loudness ON
					1			Loudness OFF
		0	0					+11.25dB
		0	1					+7.5dB
		1	0					+3.75dB
		1	1					0dB

BASS AND TREBLE DATA BYTES

The following table shows a detailed description of the Bass and Treble Data Byte. For example a Treble at -12dB is given by: 0 1 1 1 0 0 0 1 (0x71).

MSB						LSB		Function
0	1	1	0	C3	C2	C1	C0	Bass
0	1	1	1	C3	C2	C1	C0	Treble
				0	0	0	0	-14dB
				0	0	0	1	-12dB
				0	0	1	0	-10dB
				0	0	1	1	-8dB
				0	1	0	0	-6 dB
				0	1	0	1	-4 dB
				0	1	1	0	-2 dB
				0	1	1	1	0 dB
				1	1	1	1	0 dB
				1	1	1	0	+2 dB
				1	1	0	1	+4 dB
				1	1	0	0	+6 dB
				1	0	1	1	+8 dB
				1	0	1	0	+10 dB
				1	0	0	1	+12 dB
				1	0	0	0	+14 dB

TUNNING TONE CURVE CHARACTERISTICS

The tone control response character is possible tuned to match user's wishes, please refer to following chart to realize the characteristics between the different component values.

For the reasons to achieve low distortion and precision response gain, using high quality low tolerance X7R SMD capacitor on tone circuit is recommended.

The loudness boost gain is adaptive with the master volume attenuation setting, more attenuation means more low frequency boost, in the maximum volume the loudness boost will return to flat response.

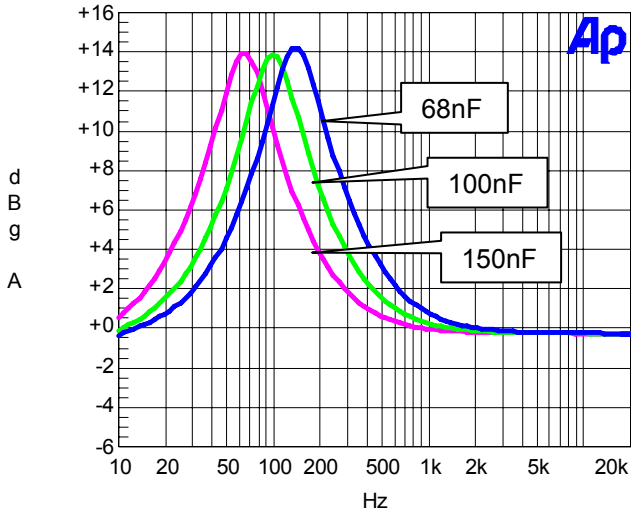

PT7313E Bass Response VS CAP

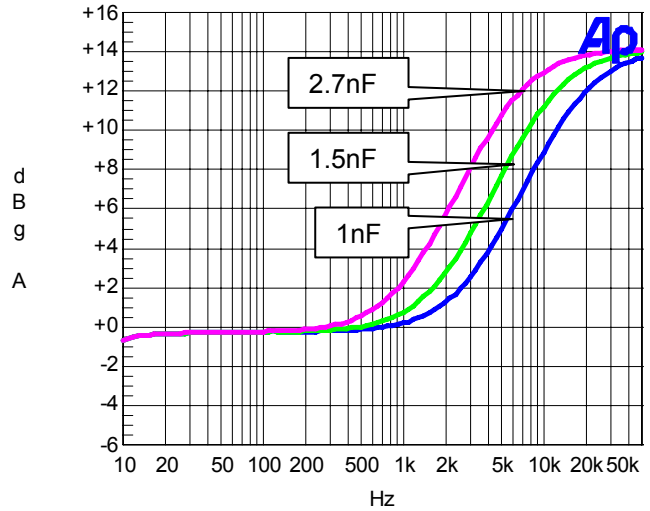

PT7313E Treble Response VS CAP

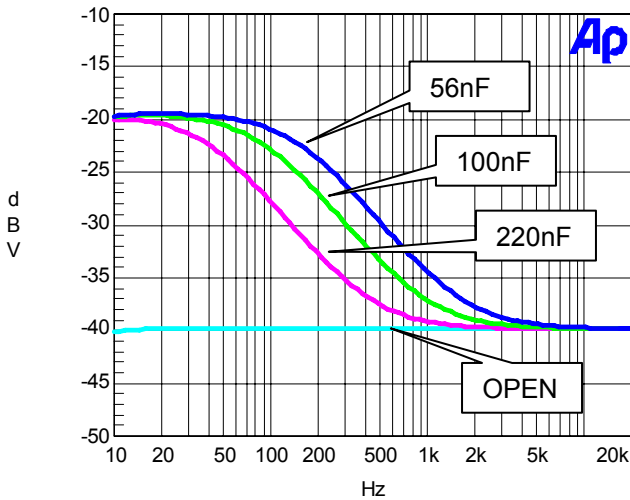

PT7313E Loudness Response VS CAP
(VOLUME=-40dB)

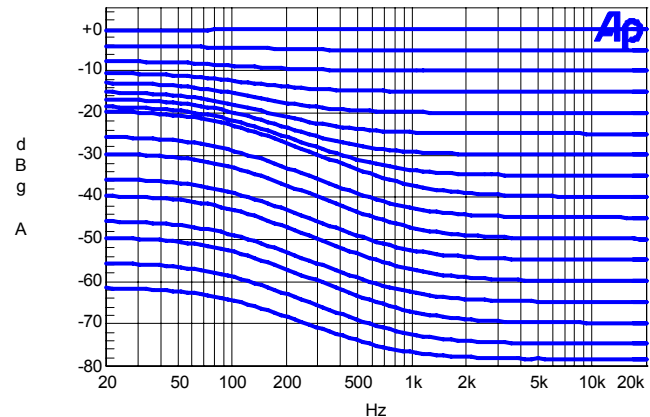

PT7313E Loudness Response VS Master Volume

ABSOLUTE MAXIMUM RATINGS

Parameter		Symbol	Min.	Max.	Unit
Operating supply voltage		VDD	-	10	V
Latch up current		Iin	-100	+100	mA
ESD grade	Human body model	HBM	-2	+2	KV
	Machine model	MM	-0.2	+0.2	KV
Input voltage		Vin	-0.3	VDD+0.3	V
Operating temperature		Topr	-40	+85	°C
Storage temperature		Tstg	-65	+150	°C

QUICK REFERENCE DATA

Parameter	Symbol	Min.	Typ.	Max.	Unit
Supply voltage	VDD	4	9	10	V
Max. input signal handling	VCL	2.3	2.6	-	Vrms
Total harmonic distortion (1Vrms,1KHz)	THD	-	0.03	0.07	%
Signal To noise ratio	S/N	-	100	-	dBV
Channel separation (f=1KHz)	Sc	-	100	-	dB
Volume control 1.25dB step	-	-78.75	-	0	dB
Bass & treble control 2dB step	-	-14	-	+14	dB
Balance control 1.25dB step	-	-37.5	-	0	dB
Input gain 3.75dB step	-	0	-	11.25	dB
Mute attenuation	-	-	100	-	dB

ELECTRICAL CHARACTERISTICS

Unless otherwise specified: Ta=25°C, VDD=9V, RL=100KΩ, Rg=20Ω, all controls flat, F=1KHz, and all of peripheral components according to standard application circuit.

Parameter	Symbol	Test Condition	Min.	Typ.	Max.	Unit
Power Supply						
Supply voltage	VDD	-	5	9	10	V
Supply current	Is	VDD=9V	-	30	40	mA
		VDD=5V	-	25	32	
Input Selectors						
Input resistance	RIN	Input 1, 2, 3	35	50	70	KΩ
Max. input level	Vimax	All Gain=0dB; THD=1%	2.3	2.6	-	Vrms
Input separation	ISIN	F=20 ~ 20KHz	90	100	-	dB
Min. input gain	GINmin	-	-1	0	1	dB
Max. input gain	GINmax	-	10.5	11.25	12	dB
Step resolution	GInst	-	-	3.75	-	dB
Gain set error	EA	-	-1	0	1	dB
Minimum load	RL	Vo=2Vrms, LOUT, ROUT	5	-	-	KΩ
DC offset	VDCO	0dB to +11.25dB	-	3	10	mV
Volume Control						
Input resistance	RIN	VOL=0dB	13	20	27	KΩ
Min. attenuation	AVMIN	-	-1	0	1	dB
Max. attenuation	AVMAX	-	-75	-78.75	-82	dB
Step resolution	ASTEP	-	1.15	1.25	1.3	dB
Attenuation set error	EA	VOL=0 ~ -70dB	-1	0	1	dB
Speaker Attenuators						
Max. Gain	AVMIN	-	-1	0	+1	dB
Max. attenuation	AVMAX	-	-36	-37.5	-39	dB
Step resolution	SSTEP	-	1.15	1.25	1.35	dB
Attenuation set error	EA	-	-1	0	1	dB
Output mute attenuation	AMUTE	-	-	100	-	dB
DC offset	VDCO	0dB to MUTE	-	5	10	mV
Bass Control						
Control range	Gb	Max. Boost/Cut	±12	±14	±16	dB
Step resolution	BSTEP	-	1.7	2	2.3	dB
Feedback resistance	RB	-	34	44	58	KΩ
Treble Control						
Control range	Gt	Max. Boost/Cut	±12	±14	±16	dB
Step resolution	TSTEP	-	1.7	2	2.3	dB
Loudness Control						
Boost gain	GLD	Volume=-40dB, F=20Hz	18	20	22	dB
Audio Outputs						
Max. output level	VOMAX	THD=1%	2.3	2.6	-	Vrms
DC voltage level	VOUT	-	0.49	0.5	0.51	VDD
Minimum load	RL	-	5	-	-	KΩ
General						
Signal to noise ratio	SNR	All Gain=0dB, A-weighted	-	100	-	dBV
		All Gains=0dB, Muted	-	100	-	
Distortion	THD	All Gain=0, Vin=1Vrms	-	0.03	0.07	%
		All Gain=0, Vin=100Vrms	-	0.01	0.03	
Channel separation	Cs	L to R or R to L channel	90	100	-	dB
I ² C crosstalk	Ct	I ² C to audio output	-	90	-	dB
Ripple rejection	PSRR	CREF=22μF, F=100Hz	-	75	-	dB
I²C Bus						
Input low voltage	VIL	VDD=9V	-	-	1	V
Input high voltage	VIH	VDD=9V	3	-	-	V
Input current	IIN	-	-5	-	+5	μA
SDA pull down voltage	Vack	Rpull up=3K, ACK=active	-	0.4	-	V

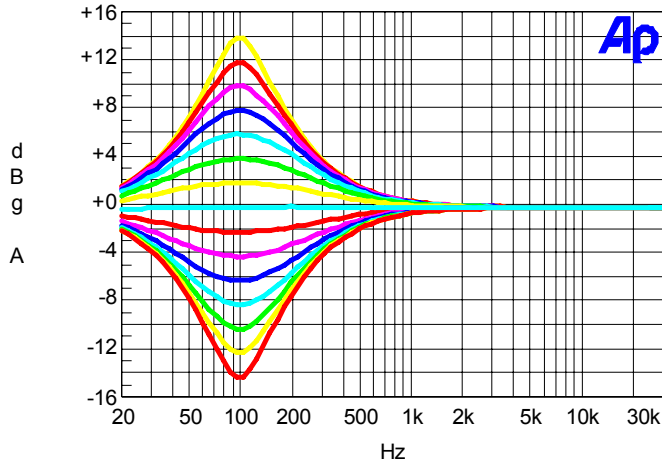

Bass Response

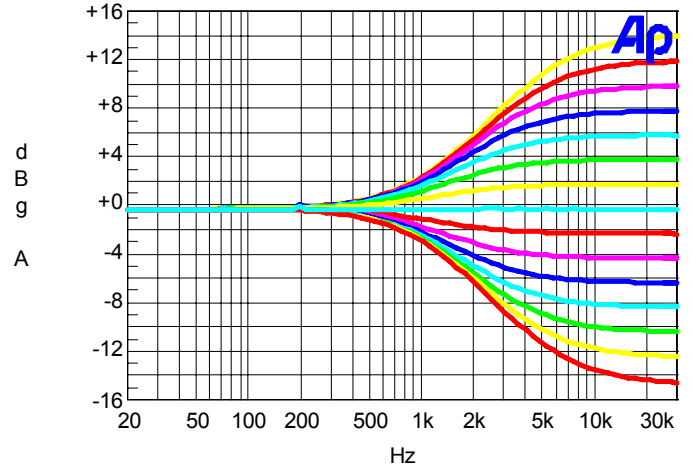

Treble Response

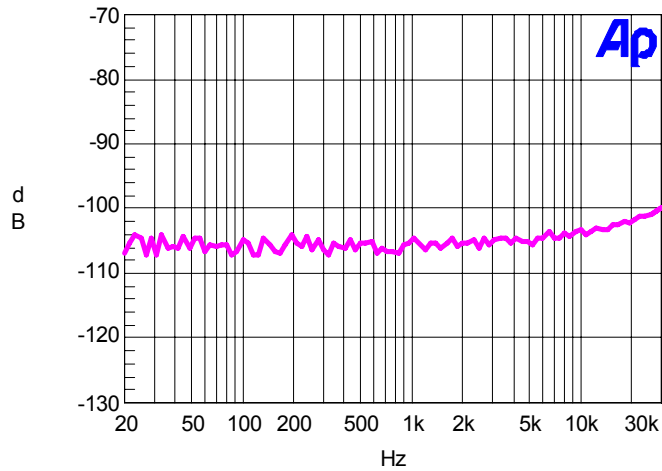

2 Channel Crosstalk

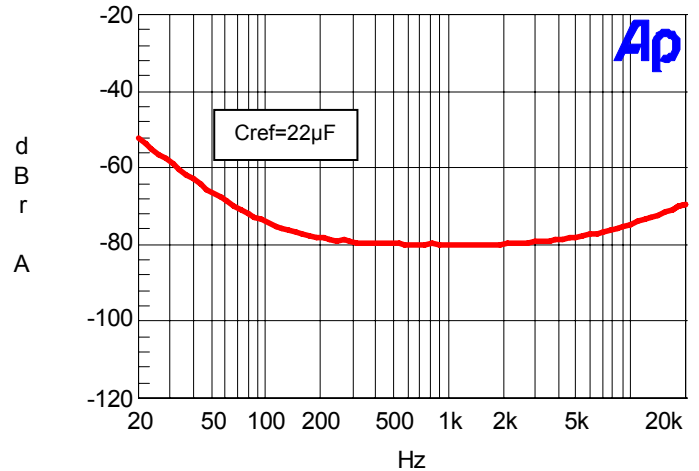

PSRR

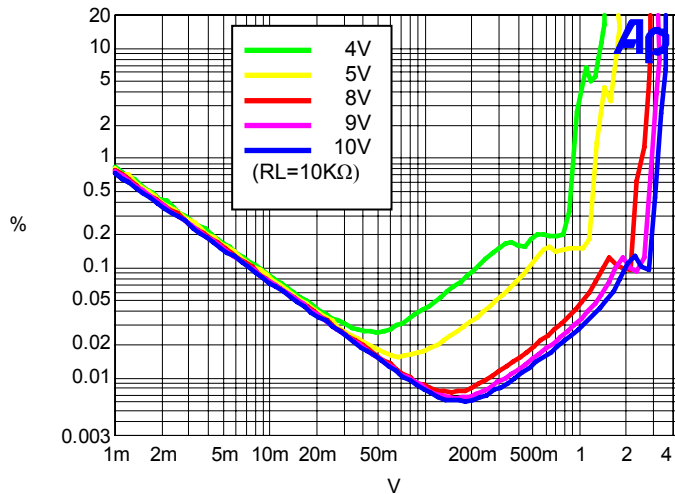

Output THD VS VDD Voltage

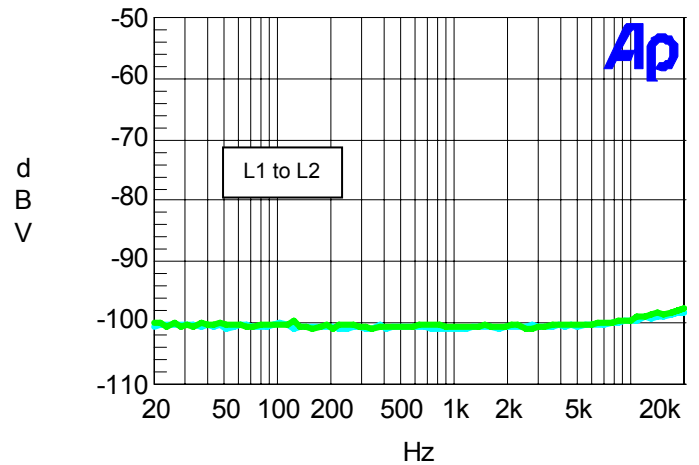

Input Selector Separation

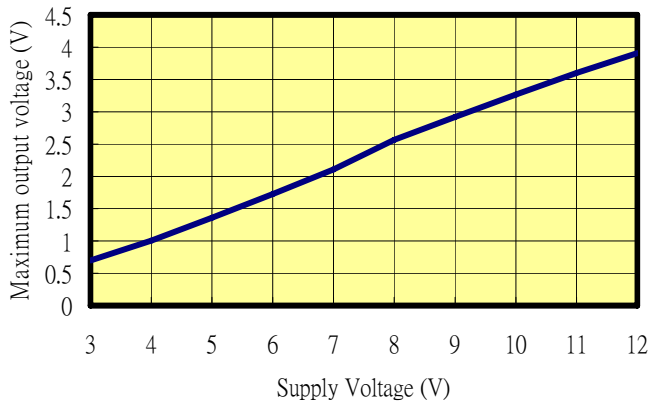

Maximum Output Level (RL=100KΩ)

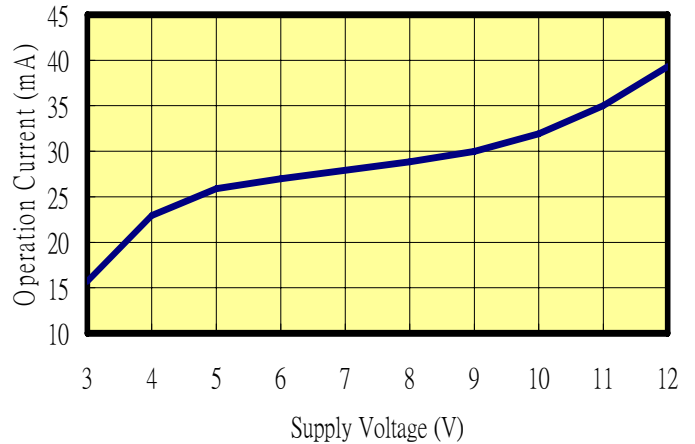

Supply Current VS VDD

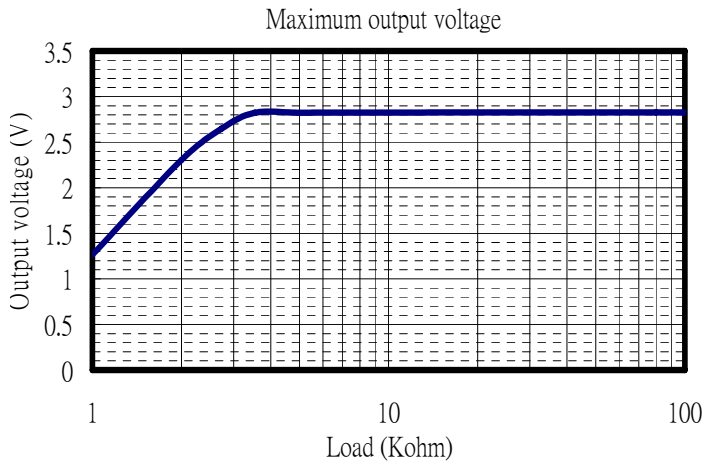

Maximum Output Level VS R_{LOAD}

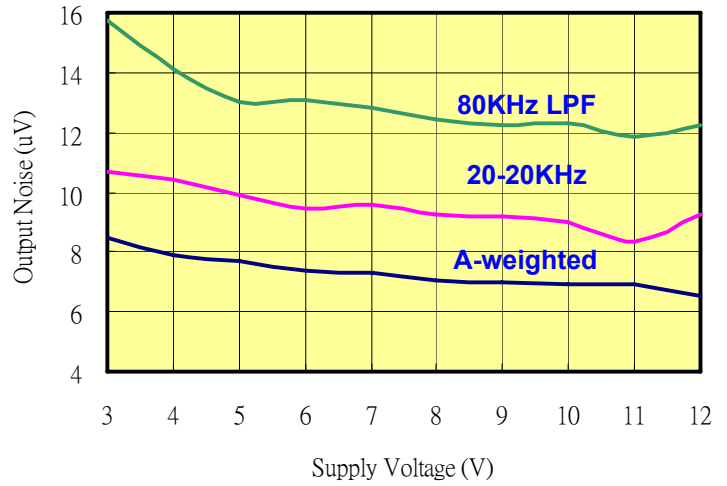

Residual Noise

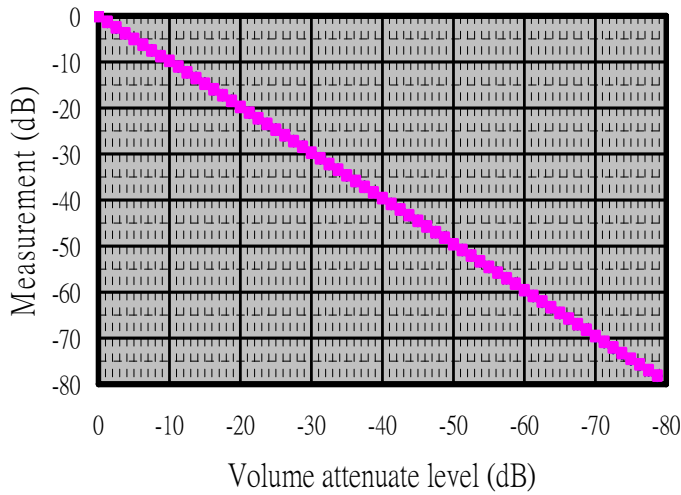

Volume Attenuation

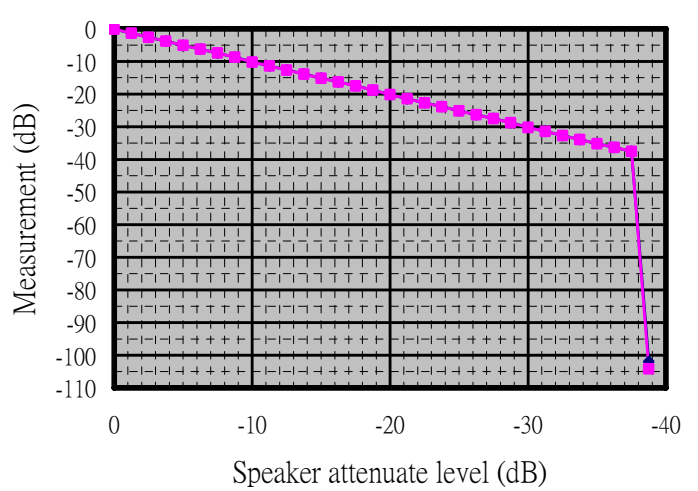

Speaker Attenuation

PACKAGE INFORMATION

28-PIN, SOP, 300MIL

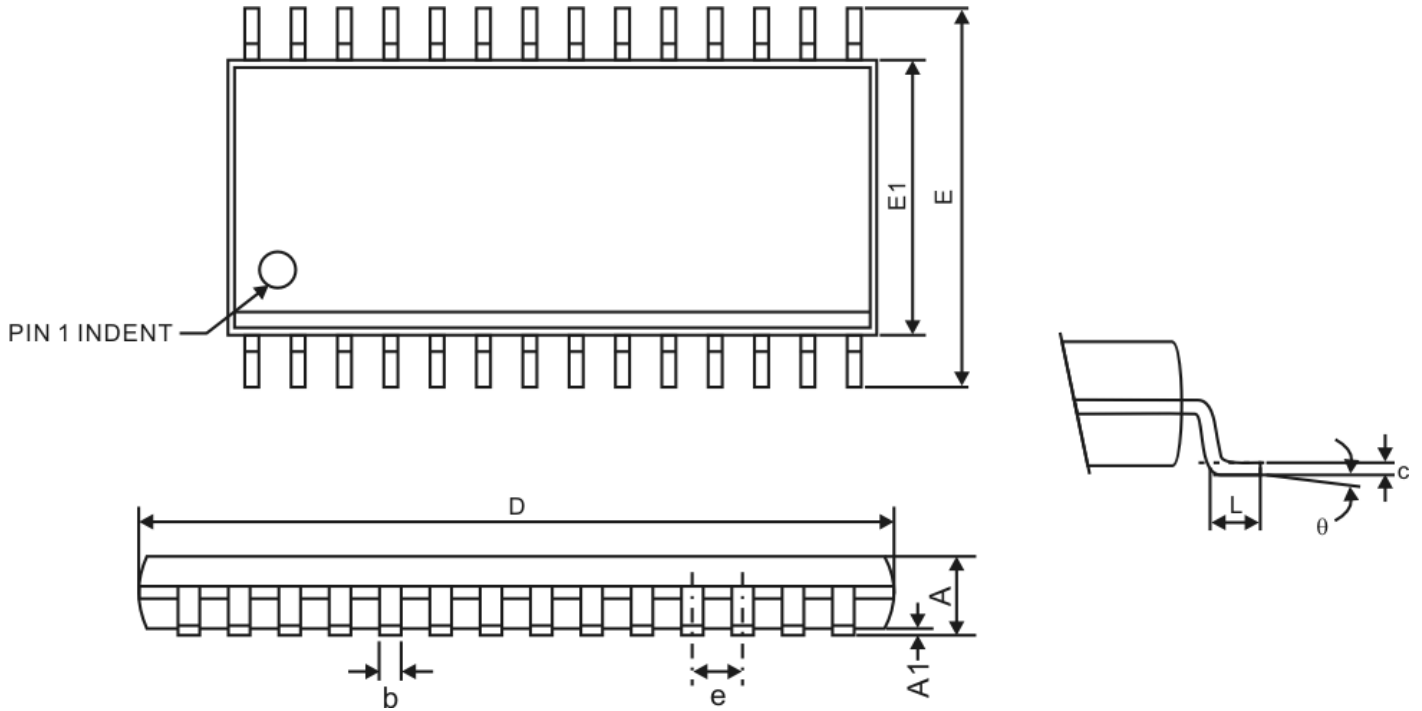

Symbol	Min.	Nom.	Max.
A	-	-	2.65
A1	0.10	-	0.30
b	0.31	-	0.51
c	0.20	-	0.33
D	17.90 BSC		
E	10.30 BSC		
E1	7.50 BSC		
e	1.27 BSC		
L	0.38	-	1.27
θ	0°	-	8°

Notes:

1. Refer to JEDEC MS-013 AE
2. All Dimensions are in millimeter.

IMPORTANT NOTICE

Princeton Technology Corporation (PTC) reserves the right to make corrections, modifications, enhancements, improvements, and other changes to its products and to discontinue any product without notice at any time.

PTC cannot assume responsibility for use of any circuitry other than circuitry entirely embodied in a PTC product. No circuit patent licenses are implied.

Princeton Technology Corp.
2F, 233-1, Baociao Road,
Sindian, Taipei 23145, Taiwan
Tel: 886-2-66296288
Fax: 886-2-29174598
<http://www.princeton.com.tw>