

RoHS Compliant Product  
A suffix of "-C" specifies halogen free

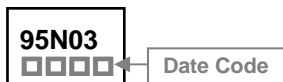
## DESCRIPTION

The SSD95N03 is the highest performance trench N-ch MOSFETs with extreme high cell density , which provide excellent  $R_{DS(ON)}$  and gate charge for most of the synchronous buck converter applications .

## FEATURES

- Advanced high cell density Trench technology
- Super Low Gate Charge
- Excellent CdV/dt effect decline
- 100% EAS Guaranteed
- Green Device Available

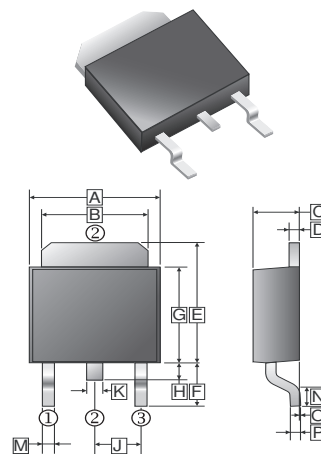
## MARKING



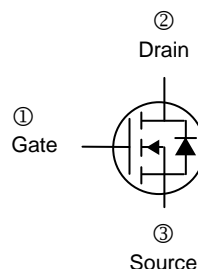
## PACKAGE INFORMATION

Package	MPQ	Leader Size
TO-252	2.5K	13 inch

## TO-252(D-Pack)



REF.	Millimeter		REF.	Millimeter	
	Min.	Max.		Min.	Max.
A	6.35	6.80	J	2.30	REF.
B	5.20	5.50	K	0.64	0.90
C	2.15	2.40	M	0.50	1.1
D	0.45	0.58	N	0.9	1.65
E	6.8	7.5	O	0	0.15
F	2.40	3.0	P	0.43	0.58
G	5.40	6.25			
H	0.64	1.20			



## ABSOLUTE MAXIMUM RATINGS ( $T_A=25^\circ\text{C}$ unless otherwise specified)

Parameter	Symbol	Rating	Unit
Drain-Source Voltage	$V_{DS}$	30	V
Gate-Source Voltage	$V_{GS}$	$\pm 20$	V
Continuous Drain Current <sup>1</sup>	$I_D$	$V_{GS}=10V, T_C=25^\circ\text{C}$	96
		$V_{GS}=10V, T_C=100^\circ\text{C}$	88
Pulsed Drain Current <sup>2</sup>	$I_{DM}$	192	A
Total Power Dissipation <sup>4</sup>	$P_D$	62.5	W
Linear Derating Factor		0.42	W / $^\circ\text{C}$
Single Pulse Avalanche Energy <sup>3</sup>	$E_{AS}$	317	mJ
Single Pulse Avalanche Current	$I_{AS}$	53.8	A
Operating Junction and Storage Temperature Range	$T_J, T_{STG}$	-55~175	$^\circ\text{C}$
<b>Thermal Resistance Rating</b>			
Maximum Thermal Resistance Junction-Ambient <sup>1</sup>	$R_{\theta JA}$	62	$^\circ\text{C} / \text{W}$
Maximum Thermal Resistance Junction-Case <sup>1</sup>	$R_{\theta JC}$	2.4	$^\circ\text{C} / \text{W}$

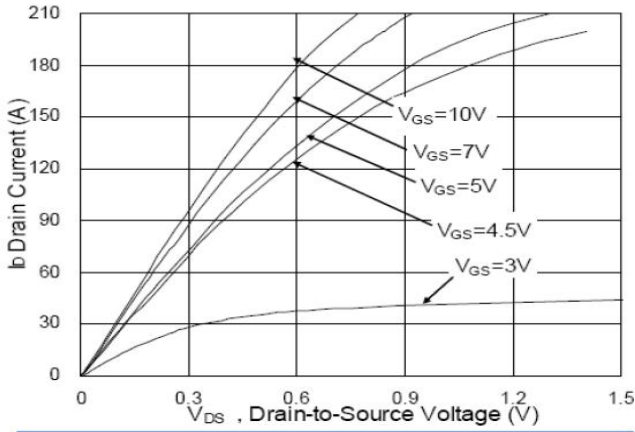
**ELECTRICAL CHARACTERISTICS** ( $T_J=25^\circ C$  unless otherwise specified)

Parameter	Symbol	Min.	Typ.	Max.	Unit	Teat Conditions	
<b>Static</b>							
Drain-Source Breakdown Voltage	$BV_{DSS}$	30	-	-	V	$V_{GS}=0, I_D=250\mu A$	
Breakdown Voltage Temperature Coefficient	$\Delta BV_{DSS} / \Delta T_J$	-	0.0213	-	V / °C	Reference to 25°C, $I_D=1mA$	
Gate-Threshold Voltage	$V_{GS(th)}$	1.0	-	2.5	V	$V_{DS}=V_{GS}, I_D=250\mu A$	
Forward Transconductance	$g_{fs}$	-	26.5	-	S	$V_{DS}=5V, I_D=30A$	
Gate-Source Leakage Current	$I_{GSS}$	-	-	$\pm 100$	nA	$V_{GS} = \pm 20V$	
Drain-Source Leakage Current	$T_J = 25^\circ C$	$I_{DSS}$	-	-	1	$\mu A$	$V_{DS}=24V, V_{GS}=0$
	$T_J = 55^\circ C$		-	-	5		$V_{DS}=24V, V_{GS}=0$
Static Drain-Source On-Resistance <sup>2</sup>	$R_{DS(ON)}$	-	3.4	4	mΩ	$V_{GS}=10V, I_D=30A$	
		-	5.2	6		$V_{GS}=4.5V, I_D=15A$	
Total Gate Charge	$Q_g$	-	31.6	-	nC	$I_D=15A$ $V_{DS}=15V$ $V_{GS}=4.5V$	
Gate-Source Charge	$Q_{gs}$	-	8.6	-			
Gate-Drain ("Miller") Change	$Q_{gd}$	-	11.7	-			
Turn-on Delay Time	$T_{d(on)}$	-	9	-	nS	$V_{DD}=15V$ $I_D=15A$ $V_{GS}=10V$ $R_G=3.3\Omega$	
Rise Time	$T_r$	-	19	-			
Turn-off Delay Time	$T_{d(off)}$	-	58	-			
Fall Time	$T_f$	-	15.2	-			
Input Capacitance	$C_{iss}$	-	3075	4000	pF	$V_{GS}=0$ $V_{DS}=15V$ $f=1.0MHz$	
Output Capacitance	$C_{oss}$	-	400	530			
Reverse Transfer Capacitance	$C_{riss}$	-	315	-			
<b>Guaranteed Avalanche Characteristics</b>							
Single Pulse Avalanche Energy <sup>5</sup>	EAS	98	-	-	mJ	$V_{DD}=25V, L=0.1mH, I_{AS}=30A$	
<b>Source-Drain Diode</b>							
Diode Forward Voltage <sup>2</sup>	$V_{SD}$	-	-	1.2	V	$I_S=30A, V_{GS}=0$	
Continuous Source Current <sup>1,6</sup>	$I_S$	-	-	96	A	$V_D=V_G=0, \text{Force Current}$	
Pulsed Source Current <sup>2,6</sup>	$I_{SM}$	-	-	192	A		

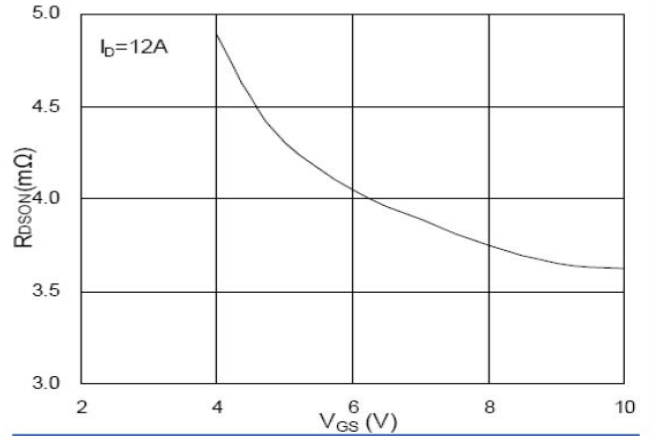
Notes:

- The data tested by surface mounted on a 1 inch<sup>2</sup> FR-4 board with 2OZ copper.
- The data tested by pulsed , pulse width  $\leq 300\mu s$  , duty cycle  $\leq 2\%$
- The EAS data shows Max. rating . The test condition is  $V_{DD}=25V, V_{GS}=10V, L=0.1mH, I_{AS}=53.8A$
- The power dissipation is limited by 175°C junction temperature
- The Min. value is 100% EAS tested guarantee.
- The data is theoretically the same as  $I_D$  and  $I_{DM}$  , in real applications , should be limited by total power dissipation.

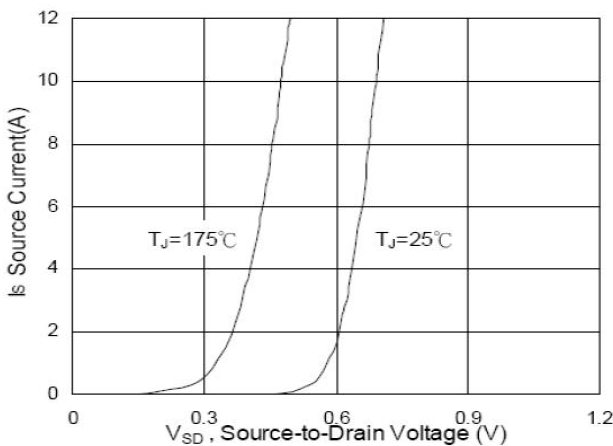
**CHARACTERISTIC CURVES**



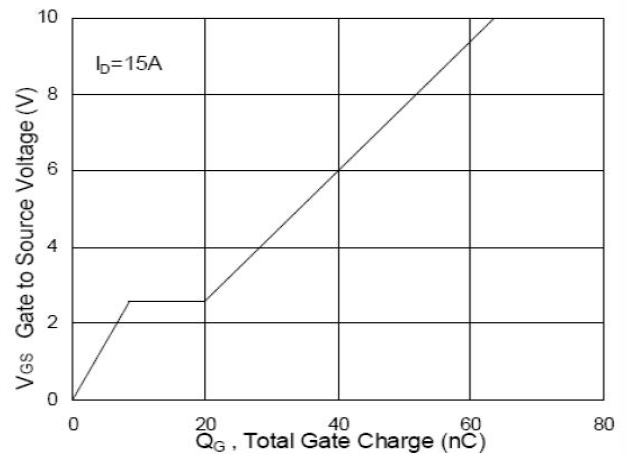
**Fig.1 Typical Output Characteristics**



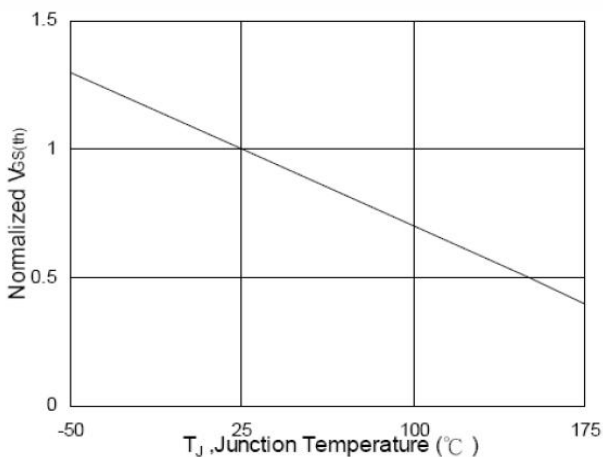
**Fig.2 On-Resistance vs. G-S Voltage**



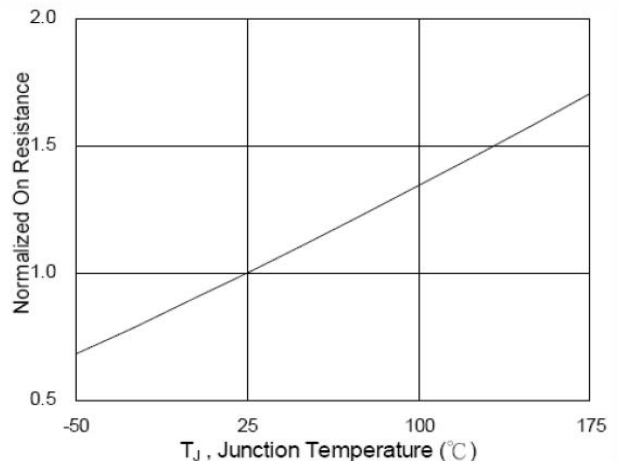
**Fig.3 Forward Characteristics of Reverse**



**Fig.4 Gate-Charge Characteristics**

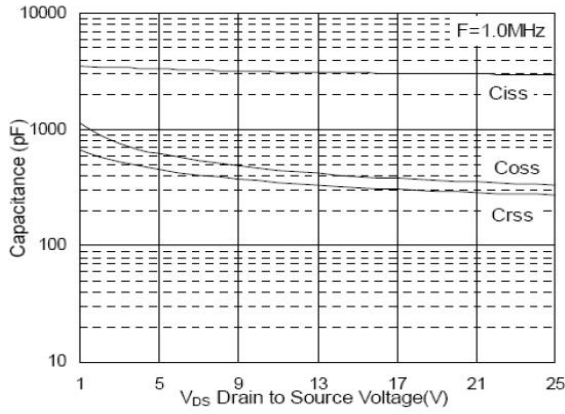


**Fig.5 Normalized  $V_{GS(th)}$  vs.  $T_J$**

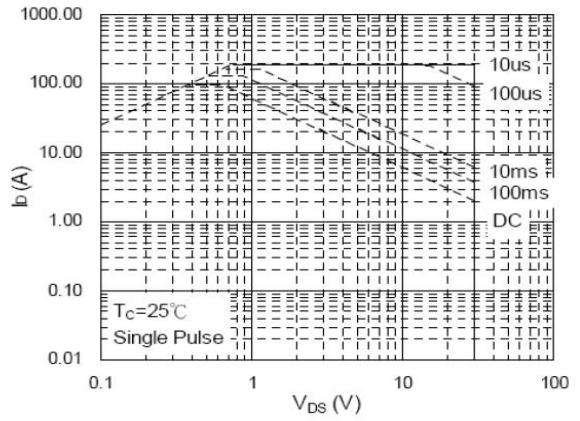


**Fig.6 Normalized  $R_{DS(ON)}$  vs.  $T_J$**

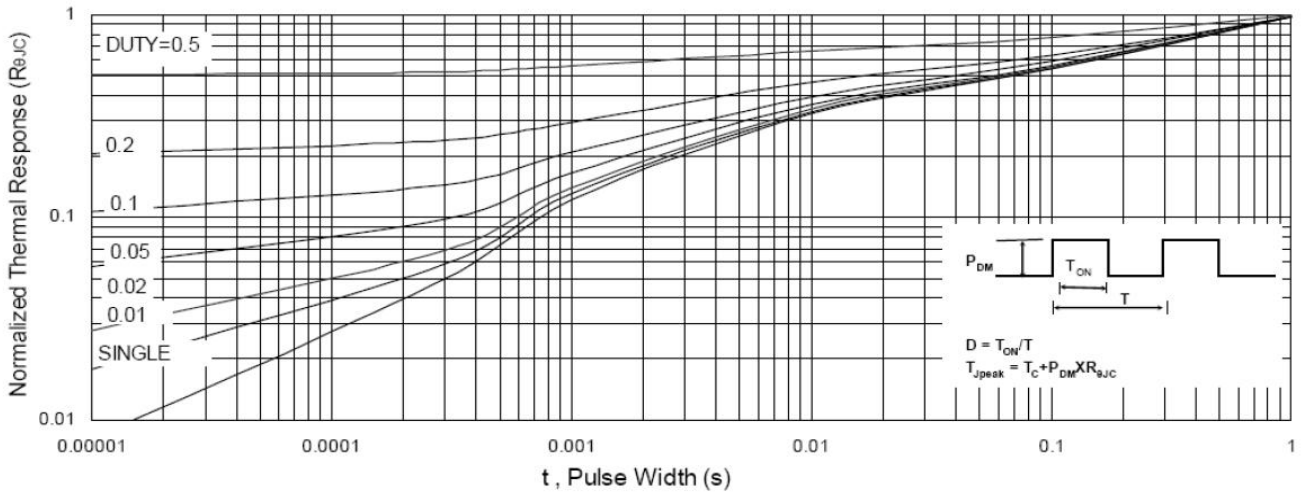
**CHARACTERISTIC CURVES**



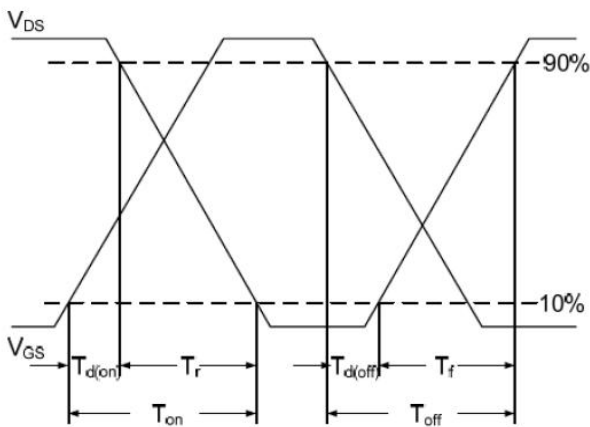
**Fig.7 Capacitance**



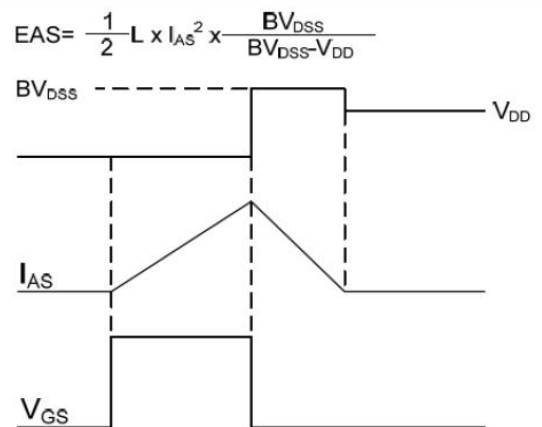
**Fig.8 Safe Operating Area**



**Fig.9 Normalized Maximum Transient Thermal Impedance**



**Fig.10 Switching Time Waveform**



**Fig.11 Unclamped Inductive Switching Wave**