

9097250 TOSHIBA (DISCRETE/OPTO)

56C 07470 DT-33-07

SILICON NPN EPITAXIAL TYPE (PCT PROCESS)

# 2SC2075

27MHZ POWER AMPLIFIER APPLICATIONS.

Unit in mm

**FEATURES:**

- Recommended for Output Stage Application of AM 4W Transmitter.
- High Power Gain.
- Wide Area of Safe Operation.

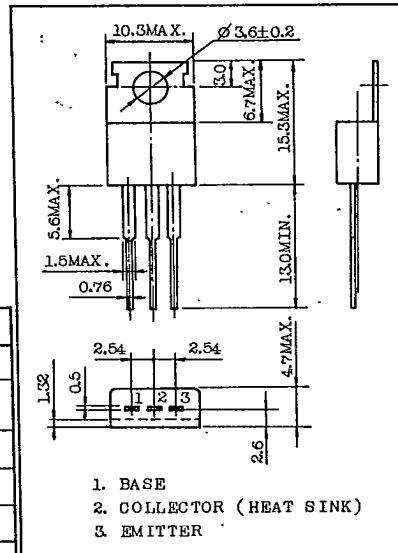

**MAXIMUM RATINGS (Ta=25°C)**

CHARACTERISTIC	SYMBOL	RATING	UNIT
Collector-Base Voltage	V <sub>CB0</sub>	80	V
Collector-Emitter Voltage R <sub>BE</sub> =50Ω	V <sub>CER</sub>	80	V
Emitter-Base Voltage	V <sub>EBO</sub>	4.0	V
Collector Current	I <sub>C</sub>	4	A
Emitter Current	I <sub>E</sub>	-4	A
Collector Power Dissipation (T <sub>c</sub> =25°C)	P <sub>C</sub>	10	W
Junction Temperature	T <sub>j</sub>	150	°C
Storage Temperature Range	T <sub>stg</sub>	-55~150	°C

JEDEC	TO - 220 AB
EIAJ	SC - 46
TOSHIBA	2 - 10 A 1 A

Mounting Kit No. AC75  
Weight : 1.9g

**ELECTRICAL CHARACTERISTICS (Ta=25°C)**

CHARACTERISTIC	SYMBOL	TEST CONDITION	MIN.	TYP.	MAX.	UNIT
Collector Cut-off Current	I <sub>CBO</sub>	V <sub>CB</sub> =30V, I <sub>E</sub> =0	-	-	10	μA
Breakdown Voltage	Collector-Emitter	V <sub>(BR)CER</sub>	80	-	-	V
	Emitter-Base	V <sub>(BR)EBO</sub>	4.0	-	-	V
DC Current Gain	h <sub>FE</sub> (1)	V <sub>CE</sub> =5V, I <sub>C</sub> =0.5A	25	-	-	
	h <sub>FE</sub> (2)	V <sub>CE</sub> =2V, I <sub>C</sub> =3A	15	-	-	
Collector-Emitter Saturation Voltage	V <sub>CE(sat)</sub>	I <sub>C</sub> =3A, I <sub>B</sub> =0.3A	-	-	1.5	V
Transition Frequency	f <sub>T</sub>	V <sub>CE</sub> =5V, I <sub>C</sub> =500mA	-	100	-	MHz
Collector Output Capacitance	C <sub>ob</sub>	V <sub>CB</sub> =10V, I <sub>E</sub> =0, f=1MHz	-	40	-	pF
Output Power (Fig. 1)	P <sub>o</sub>	V <sub>CC</sub> =12V, P <sub>i</sub> =0.3W, f=27MHz	3.5	-	-	W

Fig. 1 P<sub>o</sub> TEST CIRCUIT

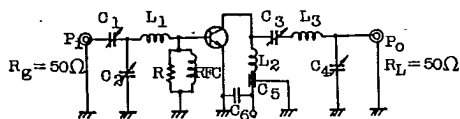

- C<sub>1</sub> : ~100pF, C<sub>2</sub>, C<sub>3</sub> : ~150pF, C<sub>4</sub> : ~300pF, C<sub>5</sub> : 1000pF
- C<sub>6</sub> : 0.01μF, R : 250Ω
- L<sub>1</sub> : 0.8mm∅ UEW, 7T, 8mm I.D, L<sub>2</sub> : 0.8mm∅ UEW, 5T, 8mm I.D
- L<sub>3</sub> : 0.8mm∅ UEW, 10T, 8mm I.D, RFC : 0.35mm∅ UEW, 17T, 5mm I.D

TOSHIBA CORPORATION

**2SC2075**

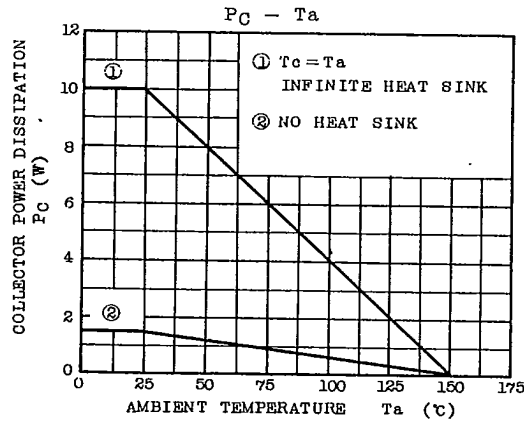
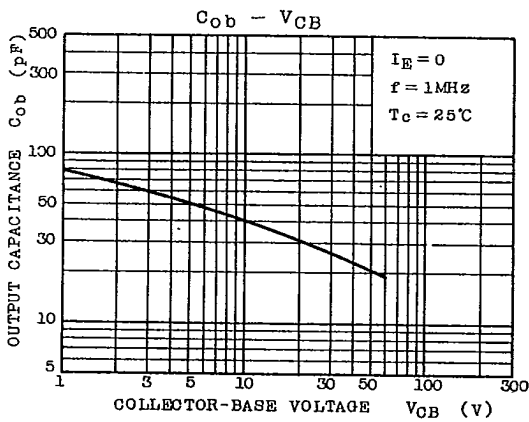
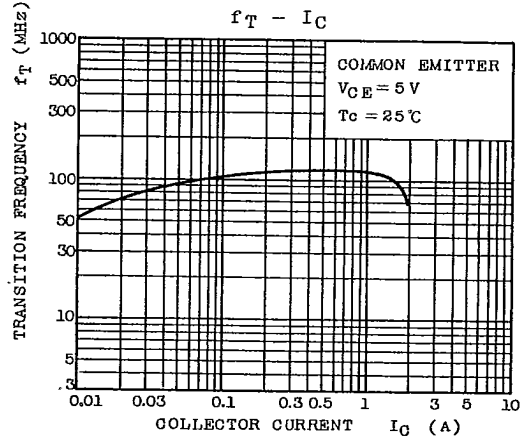
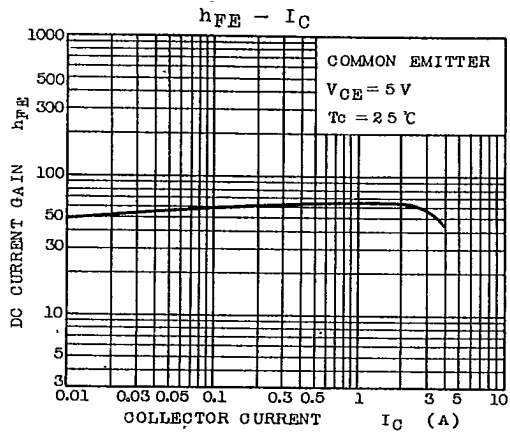
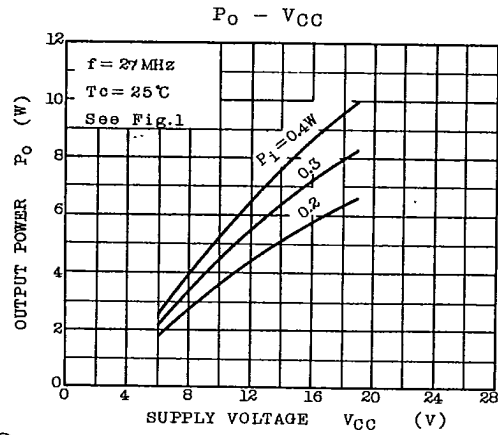
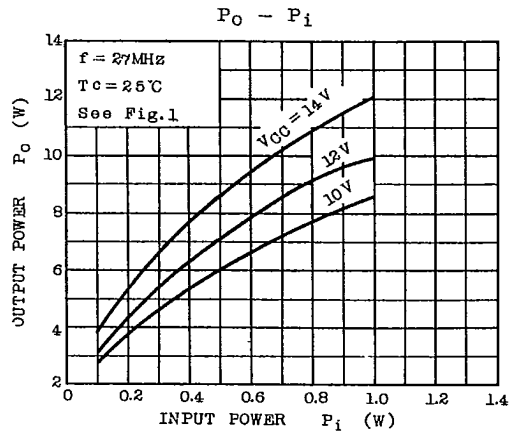

TOSHIBA CORPORATION

2SC2075

FIG.2 27MHz 4W OUTPUT AM TRANSCEIVER CIRCUIT

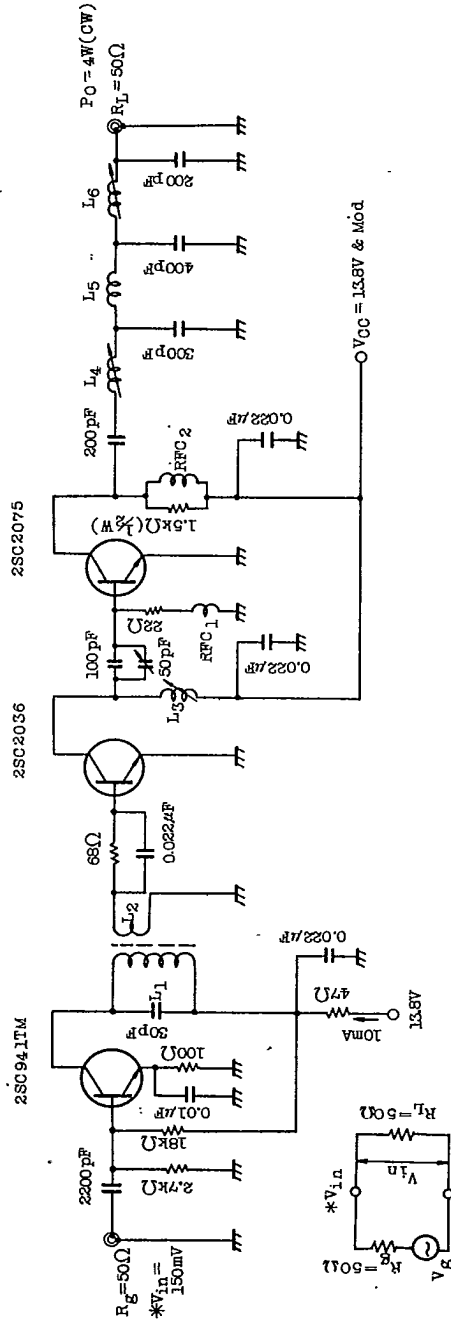

- L<sub>1</sub> : 4mm∅ BOBBIN WITH FERRITE CORE , 0.08mm∅ UEW, 8 TURNS
- L<sub>2</sub> : 4mm∅ BOBBIN WITH FERRITE CORE , 0.08mm∅ UEW, 2 TURNS
- L<sub>3</sub>, L<sub>6</sub> : 6.5mm∅ BOBBIN WITH FERRITE CORE , 0.6mm∅ Sn PLATED COPPER WIRE 6½ TURNS
- L<sub>4</sub> : 6.5mm∅ BOBBIN WITH FERRITE CORE , 0.6mm∅ Sn PLATED COPPER WIRE 8½ TURNS
- L<sub>5</sub> : 0.6mm∅ Sn PLATED COPPER WIRE , 6.5mm I.D., 8½ TURNS
- RFC<sub>1</sub> : 47 #H, 7BA-480k (TOKO)
- RFC<sub>2</sub> : 0.2mm∅ UEW, 30 TURNS

RESISTOR : ¼ W CARBON  
CAPACITOR : CERAMIC

TOSHIBA CORPORATION

**2SC2075**

APPLICATION CIRCUIT CHARACTERISTIC

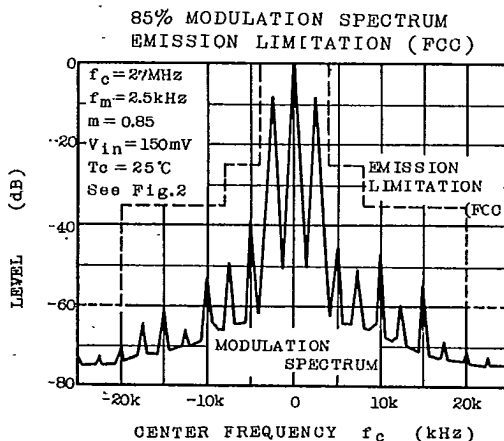
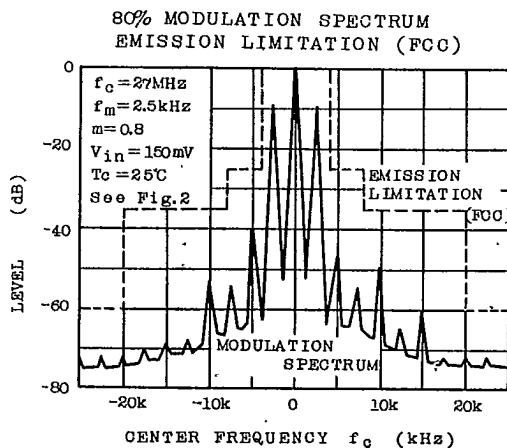
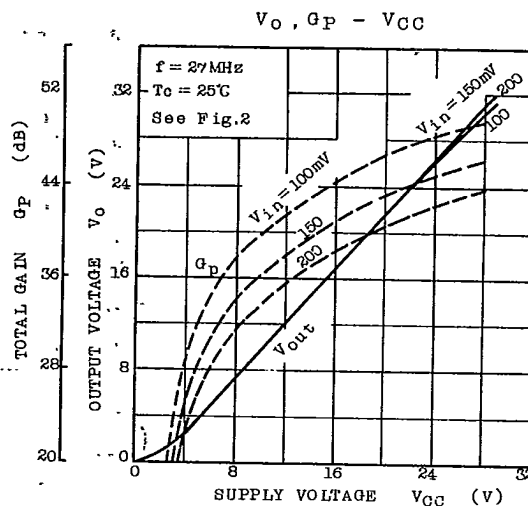
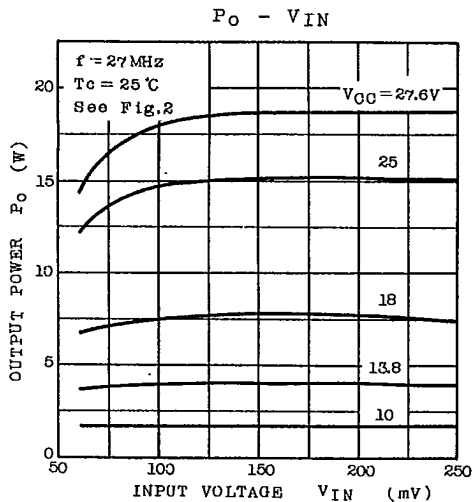

TOSHIBA CORPORATION