

45 A, 600 V ultra fast IGBT with low drop diode

Features

- Improved E_{off} at elevated temperature
- Low V_F soft recovery antiparallel diode

Applications

- Welding
- Induction heating
- Resonant converters

Description

The STGW45HF60WDI is based on a new advanced planar technology concept to yield an IGBT with more stable switching performance (E_{off}) versus temperature, as well as lower conduction losses. The device is tailored to high switching frequency operation (over 100 kHz).

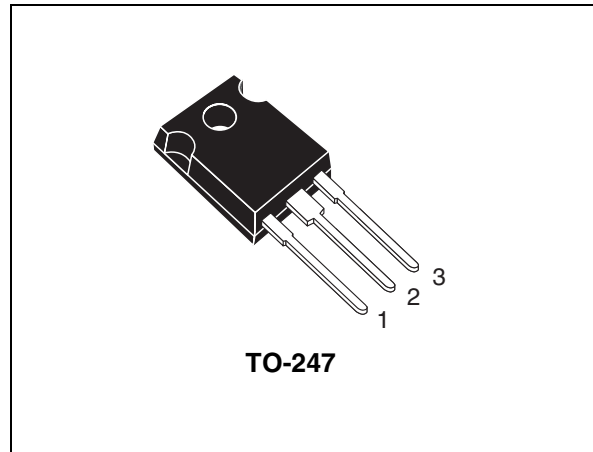

Figure 1. Internal schematic diagram

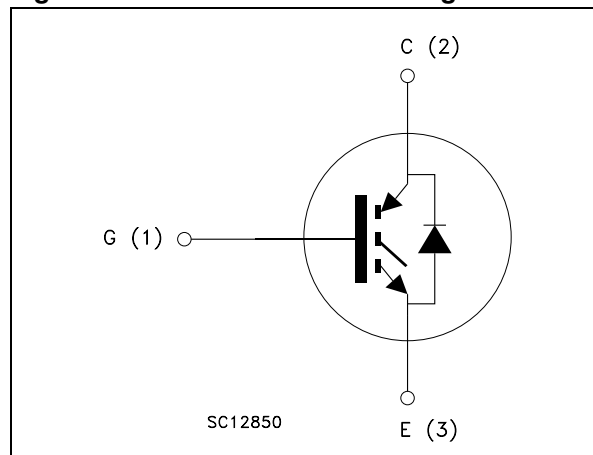

Table 1. Device summary

Order code	Marking	Package	Packaging
STGW45HF60WDI	GW45HF60WDI	TO-247	Tube
STGWA45HF60WDI	45HF60WDI	TO-247 long leads	

Content

1	Electrical ratings	3
2	Electrical characteristics	4
	2.1 Electrical characteristics (curves)	6
3	Test circuits	9
4	Package mechanical data	10
5	Revision history	15

1 Electrical ratings

Table 2. Absolute maximum ratings

Symbol	Parameter	Value		Unit
		TO-247	TO-247 long leads	
V _{CES}	Collector-emitter voltage (V _{GE} = 0)	600		V
I _C ⁽¹⁾	Continuous collector current at T _C = 25 °C	70	80	A
I _C ⁽¹⁾	Continuous collector current at T _C = 100 °C	45	50	A
I _{CP} ⁽²⁾	Pulsed collector current	150		A
I _{CL} ⁽³⁾	Turn-off latching current	80		A
V _{GE}	Gate-emitter voltage	± 20		V
I _F	Diode RMS forward current at T _C = 25 °C	30		A
I _{FSM}	Surge not repetitive forward current t _p = 10 ms sinusoidal	130		A
P _{TOT}	Total dissipation at T _C = 25 °C	250	310	W
T _{stg}	Storage temperature	- 55 to 150		°C
T _j	Operating junction temperature			

1. Calculated according to the iterative formula:

$$I_C(T_C) = \frac{T_{j(max)} - T_C}{R_{thj-c} \times V_{CE(sat)(max)}(T_{j(max)}, I_C(T_C))}$$

2. Pulse width limited by maximum junction temperature and turn-off within RBSOA

3. V_{CLAMP} = 80% (V_{CES}), V_{GE} = 15 V, R_G = 10 Ω, T_J = 150 °C

Table 3. Thermal data

Symbol	Parameter	Value		Unit
		TO-247	TO-247 long leads	
R _{thj-case}	Thermal resistance junction-case IGBT	0.5	0.4	°C/W
	Thermal resistance junction-case diode	1.5		°C/W
R _{thj-amb}	Thermal resistance junction-ambient	50		°C/W

2 Electrical characteristics

($T_J = 25\text{ °C}$ unless otherwise specified).

Table 4. Static

Symbol	Parameter	Test conditions	Min.	Typ.	Max.	Unit
$V_{(BR)CES}$	Collector-emitter breakdown voltage ($V_{GE} = 0$)	$I_C = 1\text{ mA}$	600			V
$V_{CE(sat)}$	Collector-emitter saturation voltage	$V_{GE} = 15\text{ V}, I_C = 30\text{ A}$ $V_{GE} = 15\text{ V}, I_C = 30\text{ A}, T_J = 125\text{ °C}$		1.9 1.65	2.5	V V
$V_{GE(th)}$	Gate threshold voltage	$V_{CE} = V_{GE}, I_C = 1\text{ mA}$	3.75		5.75	V
I_{CES}	Collector cut-off current ($V_{GE} = 0$)	$V_{CE} = 600\text{ V}$ $V_{CE} = 600\text{ V}, T_J = 125\text{ °C}$			500 5	μA mA
I_{GES}	Gate-emitter leakage current ($V_{CE} = 0$)	$V_{GE} = \pm 20\text{ V}$			± 100	nA

Table 5. Dynamic

Symbol	Parameter	Test conditions	Min.	Typ.	Max.	Unit
C_{ies}	Input capacitance	$V_{CE} = 25\text{ V}, f = 1\text{ MHz},$ $V_{GE} = 0$	-	2900	-	pF
C_{oes}	Output capacitance			260		pF
C_{res}	Reverse transfer capacitance			55		pF
Q_g	Total gate charge	$V_{CE} = 400\text{ V}, I_C = 30\text{ A},$	-	160	-	nC
Q_{ge}	Gate-emitter charge	$V_{GE} = 15\text{ V}$		17		nC
Q_{gc}	Gate-collector charge	Figure 18		65		nC

Table 6. Switching off (inductive load)

Symbol	Parameter	Test conditions	Min.	Typ.	Max.	Unit
$t_r(V_{off})$	Off voltage rise time	$V_{CC} = 400\text{ V}, I_C = 30\text{ A},$ $R_{GE} = 4.7\ \Omega, V_{GE} = 15\text{ V}$ Figure 17	-	30	-	ns
$t_d(off)$	Turn-off delay time			145		ns
t_f	Current fall time			50		ns
$t_r(V_{off})$	Off voltage rise time	$V_{CC} = 400\text{ V}, I_C = 30\text{ A},$ $R_{GE} = 4.7\ \Omega, V_{GE} = 15\text{ V},$ $T_J = 125\text{ °C}$ Figure 17	-	47	-	ns
$t_d(off)$	Turn-off delay time			185		ns
t_f	Current fall time			65		ns

Table 7. Switching energy (inductive load)

Symbol	Parameter	Test conditions	Min.	Typ.	Max.	Unit
E_{off}	Turn-off switching losses	$V_{CC} = 400\text{ V}$, $I_C = 30\text{ A}$ $R_G = 4.7\ \Omega$, $V_{GE} = 15\text{ V}$, <i>Figure 19</i>	-	330		μJ
E_{off}	Turn-off switching losses	$V_{CC} = 400\text{ V}$, $I_C = 30\text{ A}$ $R_G = 4.7\ \Omega$, $V_{GE} = 15\text{ V}$, $T_J = 125\text{ }^\circ\text{C}$, <i>Figure 19</i>	-	550	800	μJ

Table 8. Collector-emitter diode

Symbol	Parameter	Test conditions	Min.	Typ.	Max.	Unit
V_F	Forward on-voltage	$I_F = 30\text{ A}$ $I_F = 30\text{ A}$, $T_J = 125\text{ }^\circ\text{C}$	-	1.4 1.2	1.8	V V
t_{rr} Q_{rr} I_{rrm}	Reverse recovery time Reverse recovery charge Reverse recovery current	$I_F = 30\text{ A}$, $V_R = 50\text{ V}$, $di/dt = 100\text{ A}/\mu\text{s}$ <i>Figure 20</i>	-	90 305 5.2	-	ns nC A
t_{rr} Q_{rr} I_{rrm}	Reverse recovery time Reverse recovery charge Reverse recovery current	$I_F = 30\text{ A}$, $V_R = 50\text{ V}$, $T_J = 125\text{ }^\circ\text{C}$, $di/dt = 100\text{ A}/\mu\text{s}$ <i>Figure 20</i>	-	235 1100 9	-	ns nC A

2.1 Electrical characteristics (curves)

Figure 2. Output characteristics

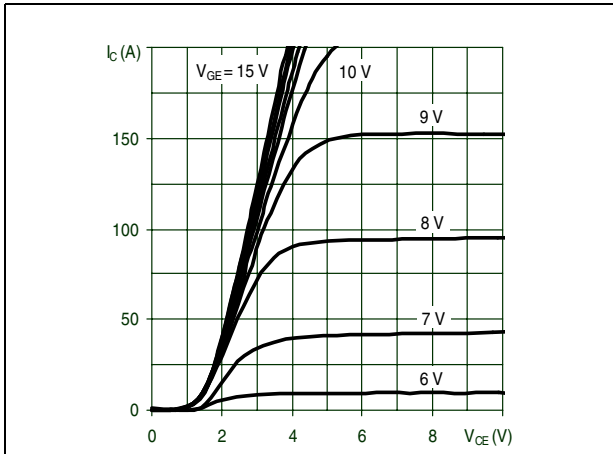

Figure 3. Transfer characteristics

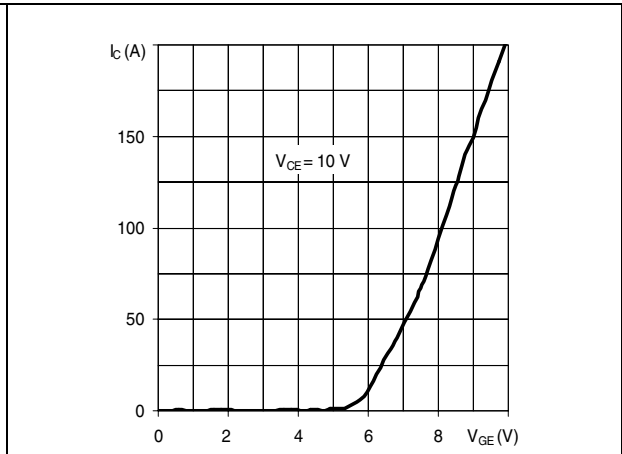

Figure 4. Normalized $V_{CE(sat)}$ vs. I_c

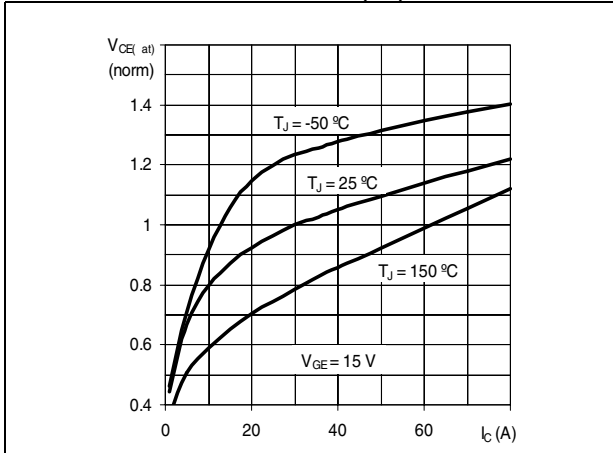

Figure 5. Normalized $V_{CE(sat)}$ vs. temperature

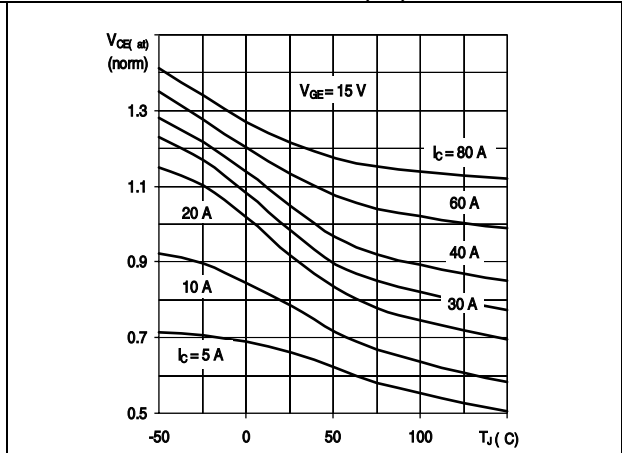

Figure 6. Normalized breakdown voltage vs. temperature

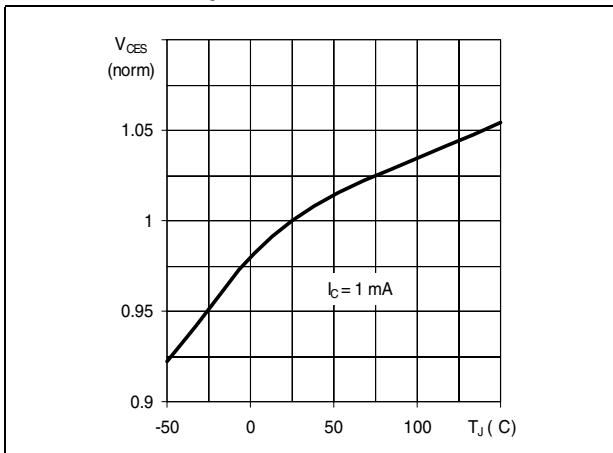

Figure 7. Normalized gate threshold voltage vs. temperature

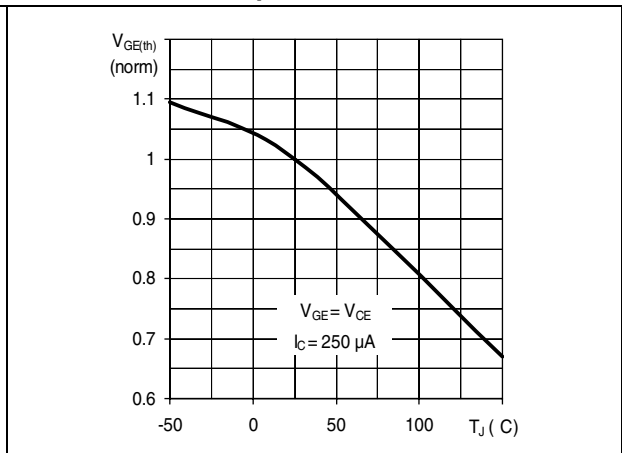

Figure 8. Gate charge vs. gate-emitter voltage

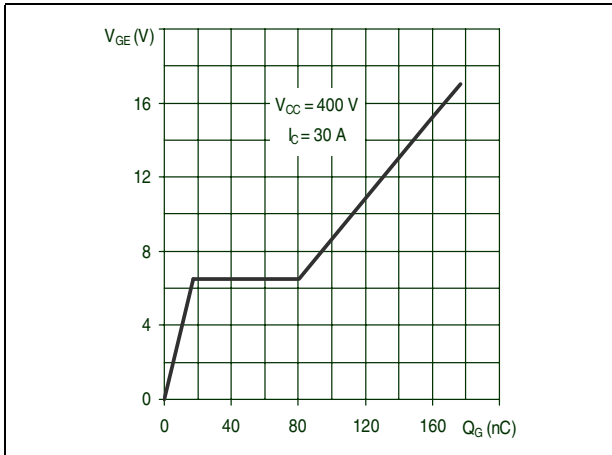

Figure 9. Capacitances variations

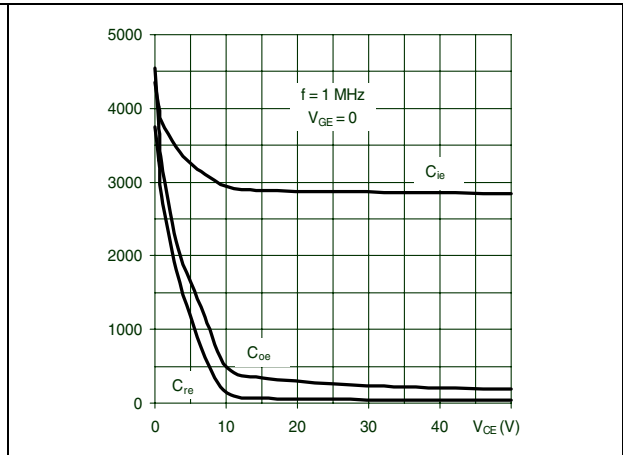

Figure 10. Switching losses vs. temperature

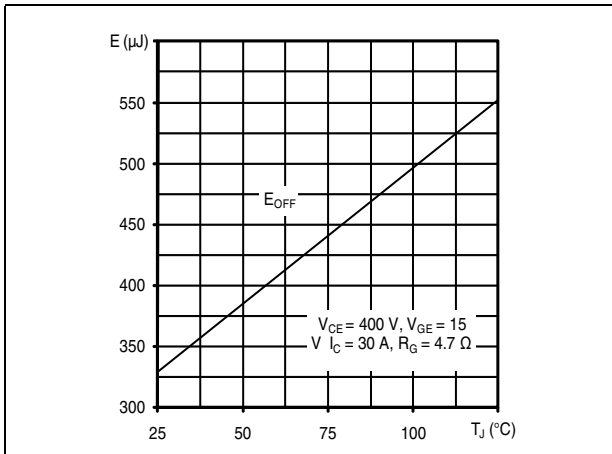

Figure 11. Switching losses vs. gate resistance

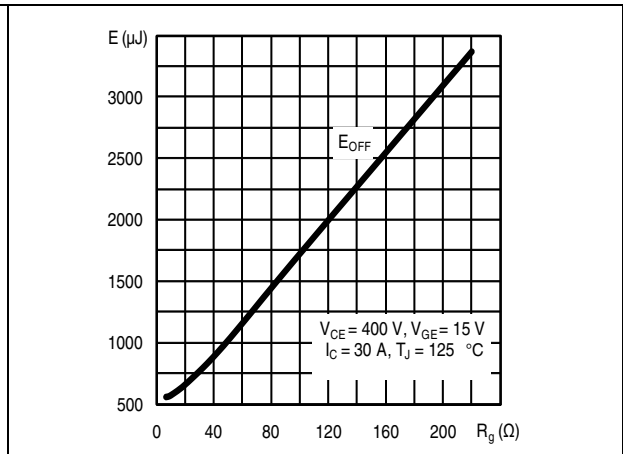

Figure 12. Switching losses vs. collector current

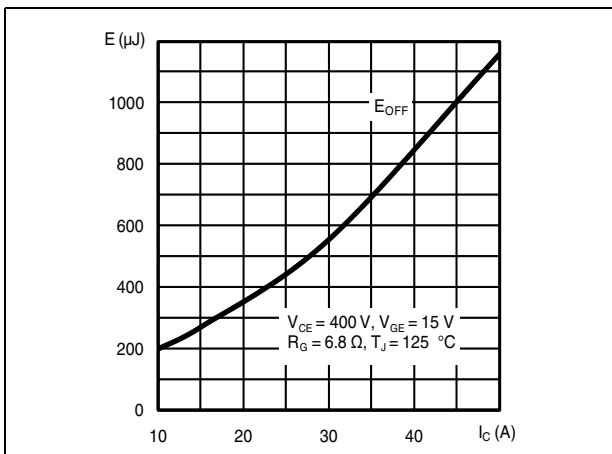

Figure 13. Turn-off SOA

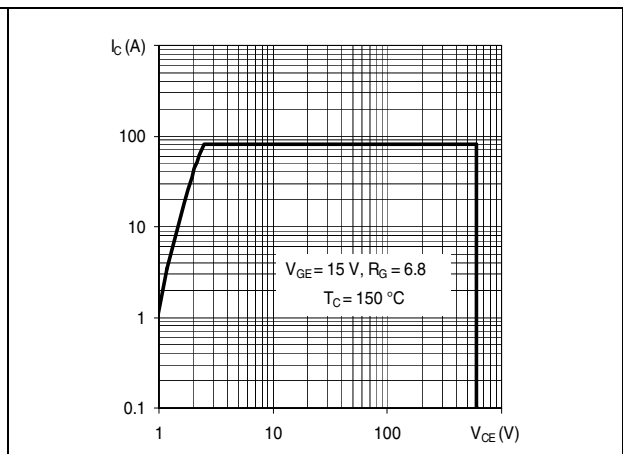

Figure 14. Diode forward on voltage

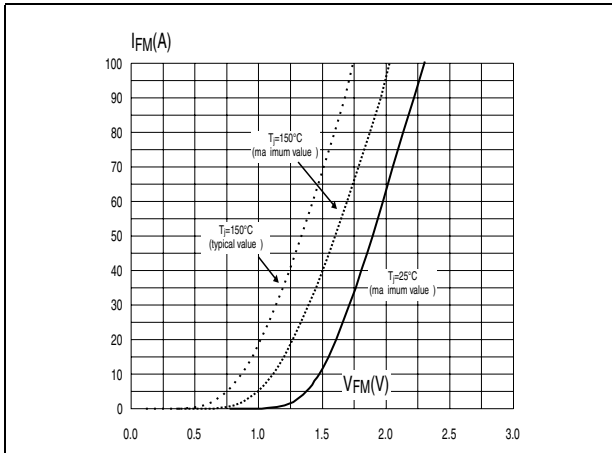

Figure 15. Thermal impedance for TO-247

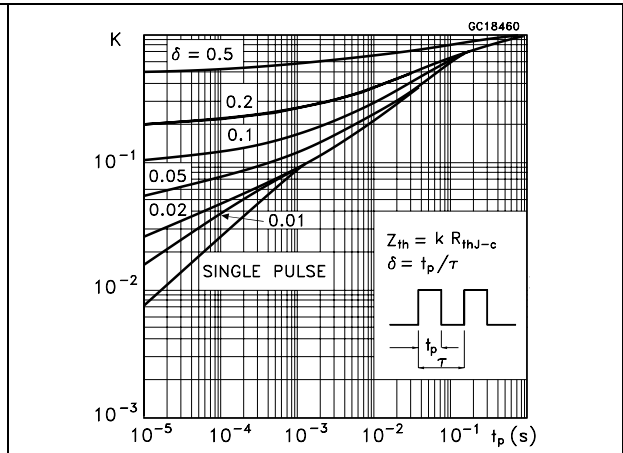
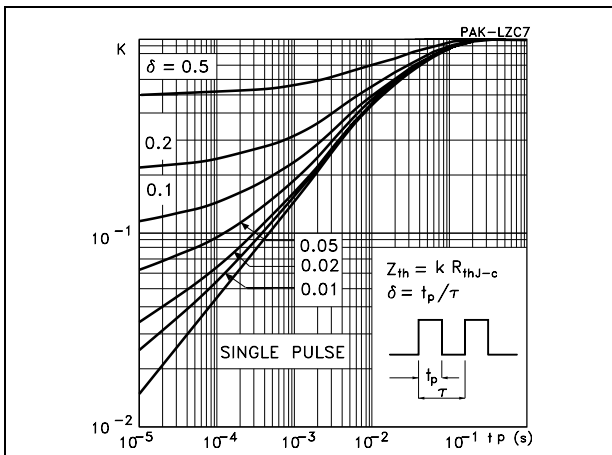

Figure 16. Thermal impedance for TO-247 narrow leads



4 Package mechanical data

In order to meet environmental requirements, ST offers these devices in different grades of ECOPACK® packages, depending on their level of environmental compliance. ECOPACK® specifications, grade definitions and product status are available at: www.st.com. ECOPACK is an ST trademark.

Table 9. TO-247 mechanical data

Dim.	mm		
	Min.	Typ.	Max.
A	4.85		5.15
A1	2.20		2.60
b	1.0		1.40
b1	2.0		2.40
b2	3.0		3.40
c	0.40		0.80
D	19.85		20.15
E	15.45		15.75
e		5.45	
L	14.20		14.80
L1	3.70		4.30
L2		18.50	
ØP	3.55		3.65
ØR	4.50		5.50
S		5.50	

Figure 21. TO-247 drawing

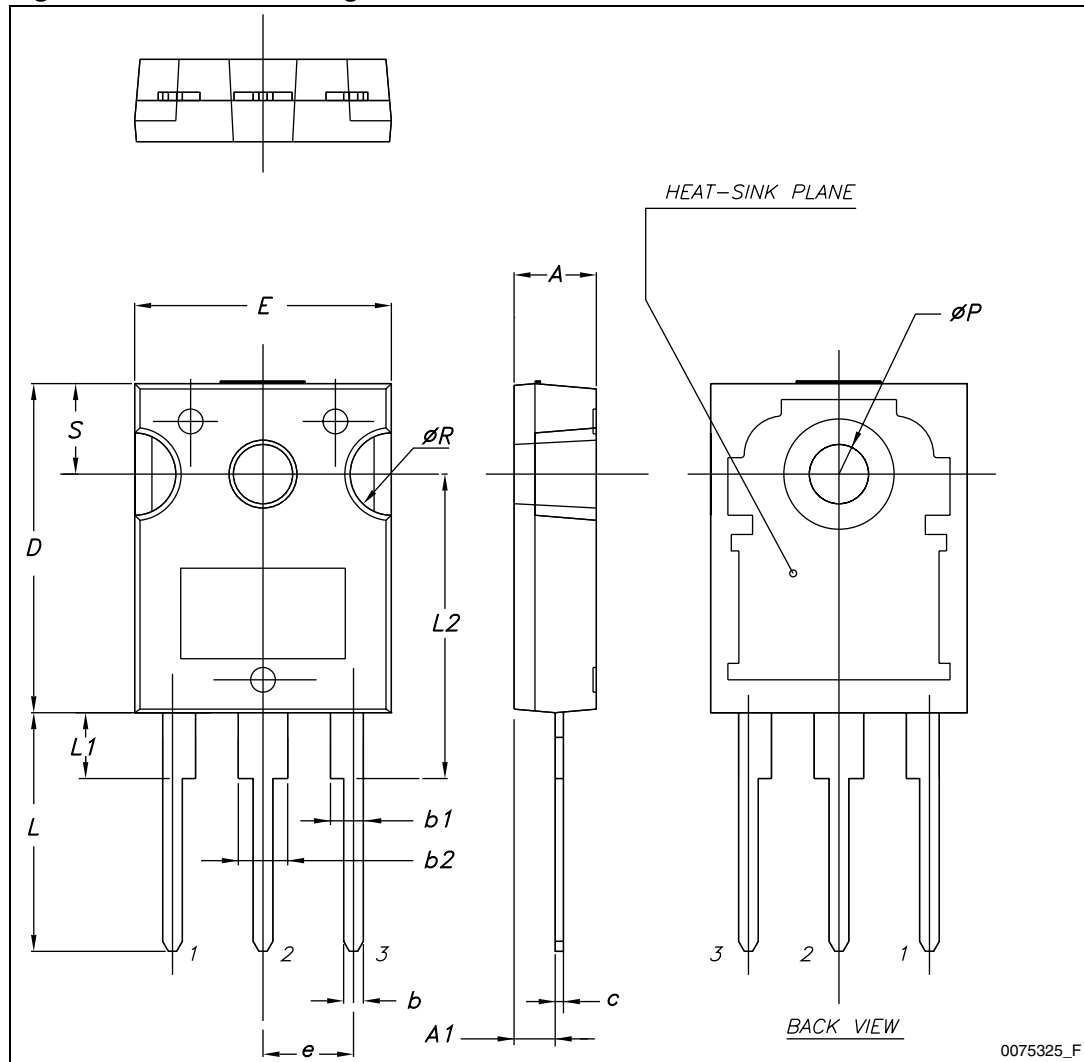
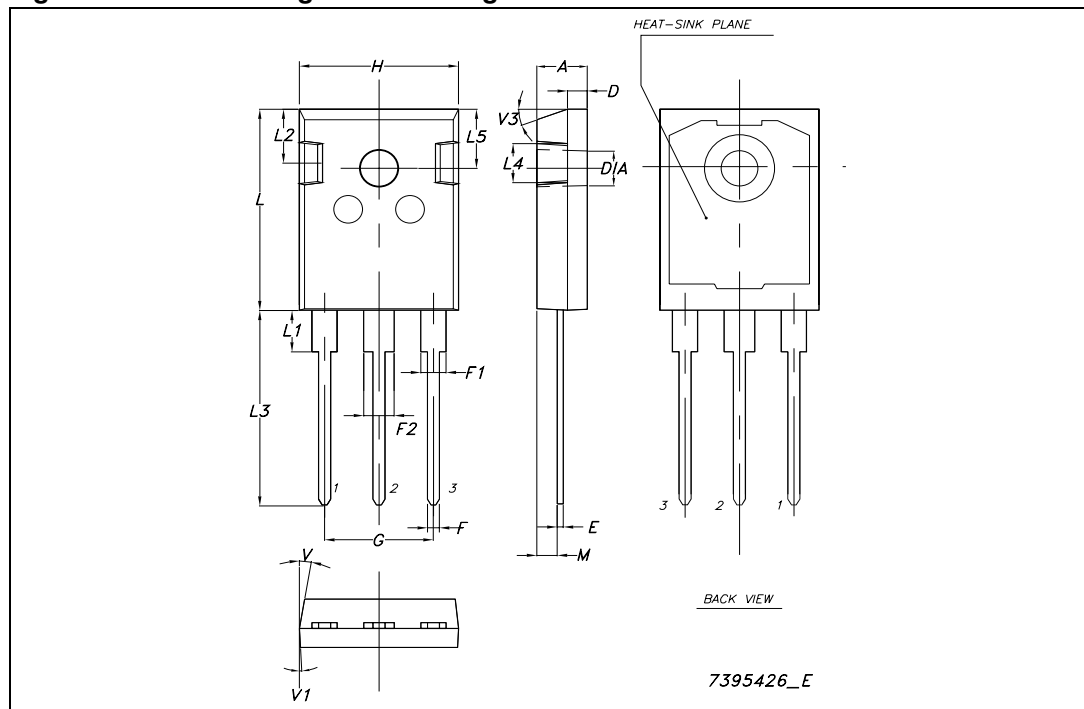

Table 10. TO-247 long leads mechanical data

Dim.	mm		
	Min.	Typ.	Max.
A	4.90		5.15
D	1.85		2.10
E	0.55		0.67
F	1.07		1.32
F1	1.90		2.38
F2	2.87		3.38
G	10.90 BSC		
H	15.77		16.02
L	20.82		21.07
L1	4.16		4.47
L2	5.49		5.74
L3	20.05		20.30
L4	3.68		3.93
L5	6.04		6.29
M	2.27		2.52
V		10°	
V1		3°	
V3		20°	
Dia.	3.55		3.66

Figure 22. TO-247 long leads drawing



5 Revision history

Table 11. Document revision history

Date	Revision	Changes
04-Aug-2009	1	Initial release.
21-Dec-2010	2	Document status promoted from preliminary data to datasheet. Inserted dynamic parameters on Table 5 , Table 6 , Table 7 and Table 8 . Inserted Section 2.1: Electrical characteristics (curves) . Updated TO-247 long leads package mechanical data.

Please Read Carefully:

Information in this document is provided solely in connection with ST products. STMicroelectronics NV and its subsidiaries ("ST") reserve the right to make changes, corrections, modifications or improvements, to this document, and the products and services described herein at any time, without notice.

All ST products are sold pursuant to ST's terms and conditions of sale.

Purchasers are solely responsible for the choice, selection and use of the ST products and services described herein, and ST assumes no liability whatsoever relating to the choice, selection or use of the ST products and services described herein.

No license, express or implied, by estoppel or otherwise, to any intellectual property rights is granted under this document. If any part of this document refers to any third party products or services it shall not be deemed a license grant by ST for the use of such third party products or services, or any intellectual property contained therein or considered as a warranty covering the use in any manner whatsoever of such third party products or services or any intellectual property contained therein.

UNLESS OTHERWISE SET FORTH IN ST'S TERMS AND CONDITIONS OF SALE ST DISCLAIMS ANY EXPRESS OR IMPLIED WARRANTY WITH RESPECT TO THE USE AND/OR SALE OF ST PRODUCTS INCLUDING WITHOUT LIMITATION IMPLIED WARRANTIES OF MERCHANTABILITY, FITNESS FOR A PARTICULAR PURPOSE (AND THEIR EQUIVALENTS UNDER THE LAWS OF ANY JURISDICTION), OR INFRINGEMENT OF ANY PATENT, COPYRIGHT OR OTHER INTELLECTUAL PROPERTY RIGHT.

UNLESS EXPRESSLY APPROVED IN WRITING BY AN AUTHORIZED ST REPRESENTATIVE, ST PRODUCTS ARE NOT RECOMMENDED, AUTHORIZED OR WARRANTED FOR USE IN MILITARY, AIR CRAFT, SPACE, LIFE SAVING, OR LIFE SUSTAINING APPLICATIONS, NOR IN PRODUCTS OR SYSTEMS WHERE FAILURE OR MALFUNCTION MAY RESULT IN PERSONAL INJURY, DEATH, OR SEVERE PROPERTY OR ENVIRONMENTAL DAMAGE. ST PRODUCTS WHICH ARE NOT SPECIFIED AS "AUTOMOTIVE GRADE" MAY ONLY BE USED IN AUTOMOTIVE APPLICATIONS AT USER'S OWN RISK.

Resale of ST products with provisions different from the statements and/or technical features set forth in this document shall immediately void any warranty granted by ST for the ST product or service described herein and shall not create or extend in any manner whatsoever, any liability of ST.

ST and the ST logo are trademarks or registered trademarks of ST in various countries.

Information in this document supersedes and replaces all information previously supplied.

The ST logo is a registered trademark of STMicroelectronics. All other names are the property of their respective owners.

© 2010 STMicroelectronics - All rights reserved

STMicroelectronics group of companies

Australia - Belgium - Brazil - Canada - China - Czech Republic - Finland - France - Germany - Hong Kong - India - Israel - Italy - Japan - Malaysia - Malta - Morocco - Philippines - Singapore - Spain - Sweden - Switzerland - United Kingdom - United States of America

www.st.com