

80V/2.5A Peak, High Frequency Full Bridge FET Driver

The HIP4081A is a high frequency, medium voltage Full Bridge N-Channel FET driver IC, available in 20 lead plastic SOIC and DIP packages. The HIP4081A can drive every possible switch combination except those which would cause a shoot-through condition. The HIP4081A can switch at frequencies up to 1MHz and is well suited to driving Voice Coil Motors, high-frequency switching power amplifiers, and power supplies.

For example, the HIP4081A can drive medium voltage brush motors, and two HIP4081As can be used to drive high performance stepper motors, since the short minimum “on-time” can provide fine micro-stepping capability.

Short propagation delays of approximately 55ns maximizes control loop crossover frequencies and dead-times which can be adjusted to near zero to minimize distortion, resulting in rapid, precise control of the driven load.

A similar part, the HIP4080A, includes an on-chip input comparator to create a PWM signal from an external triangle wave and to facilitate “hysteresis mode” switching.

The Application Note for the HIP4081A is the AN9405.

Ordering Information

PART NUMBER	TEMP RANGE (°C)	PACKAGE	PKG. DWG. #
HIP4081AIP (No longer available, recommended replacement: HIP4081AIPZ)	-40 to 85	20 Ld PDIP	E20.3
HIP4081AIPZ (Note)	-40 to 85	20 Ld PDIP (Pb-free)	E20.3
HIP4081AIB	-40 to 85	20 Ld SOIC (W)	M20.3
HIP4081AIBZ (Note)	-40 to 85	20 Ld SOIC (W) (Pb-free)	M20.3

NOTE: Intersil Pb-free products employ special Pb-free material sets; molding compounds/die attach materials and 100% matte tin plate termination finish, which is compatible with both SnPb and Pb-free soldering operations. Intersil Pb-free products are MSL classified at Pb-free peak reflow temperatures that meet or exceed the Pb-free requirements of IPC/JEDEC J Std-020B.

Features

- Independently Drives 4 N-Channel FET in Half Bridge or Full Bridge Configurations
- Bootstrap Supply Max Voltage to 95V_{DC}
- Drives 1000pF Load at 1MHz in Free Air at 50°C with Rise and Fall Times of Typically 10ns
- User-Programmable Dead Time
- On-Chip Charge-Pump and Bootstrap Upper Bias Supplies
- DIS (Disable) Overrides Input Control
- Input Logic Thresholds Compatible with 5V to 15V Logic Levels
- Very Low Power Consumption
- Undervoltage Protection
- Pb-free Available

Applications

- Medium/Large Voice Coil Motors
- Full Bridge Power Supplies
- Switching Power Amplifiers
- High Performance Motor Controls
- Noise Cancellation Systems
- Battery Powered Vehicles
- Peripherals
- U.P.S.

Pinout

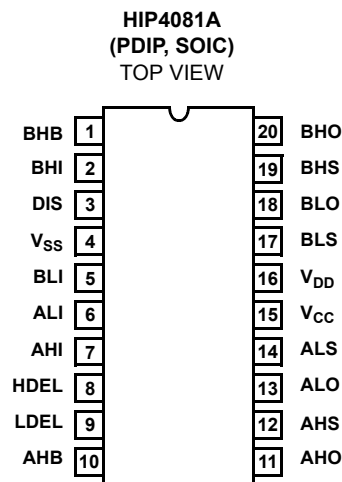

HIP4081A

Application Block Diagram

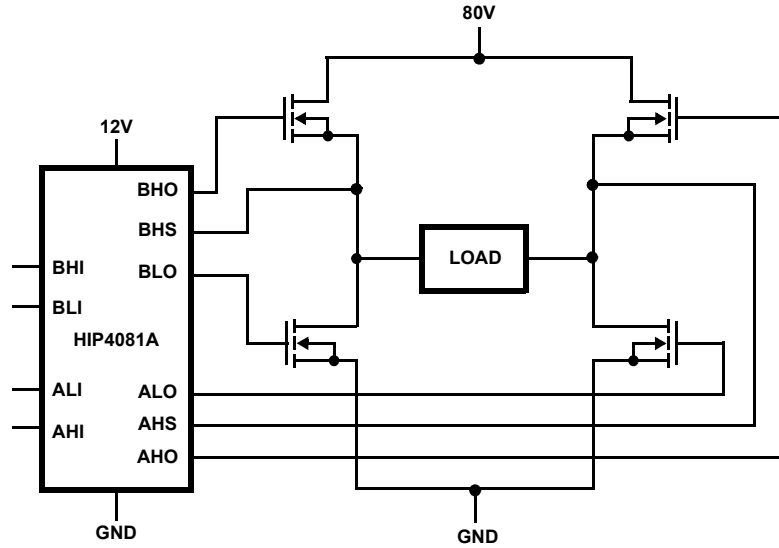

Functional Block Diagram (1/2 HIP4081A)

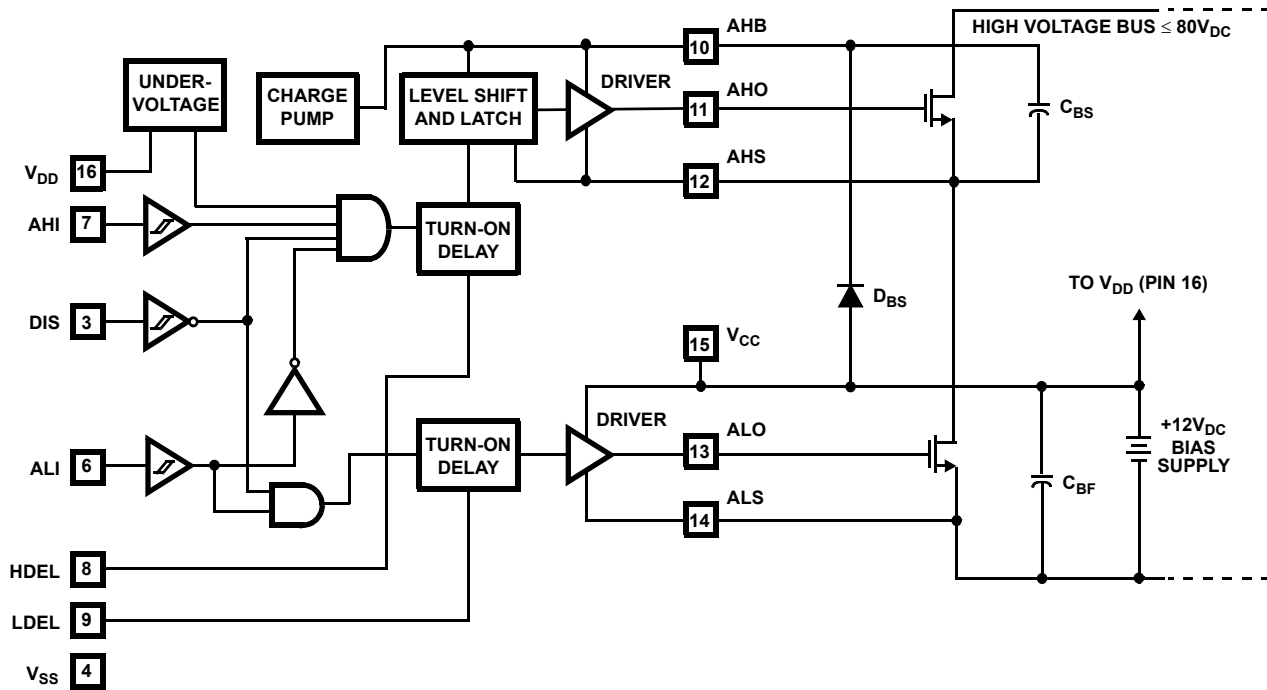

Typical Application (PWM Mode Switching)

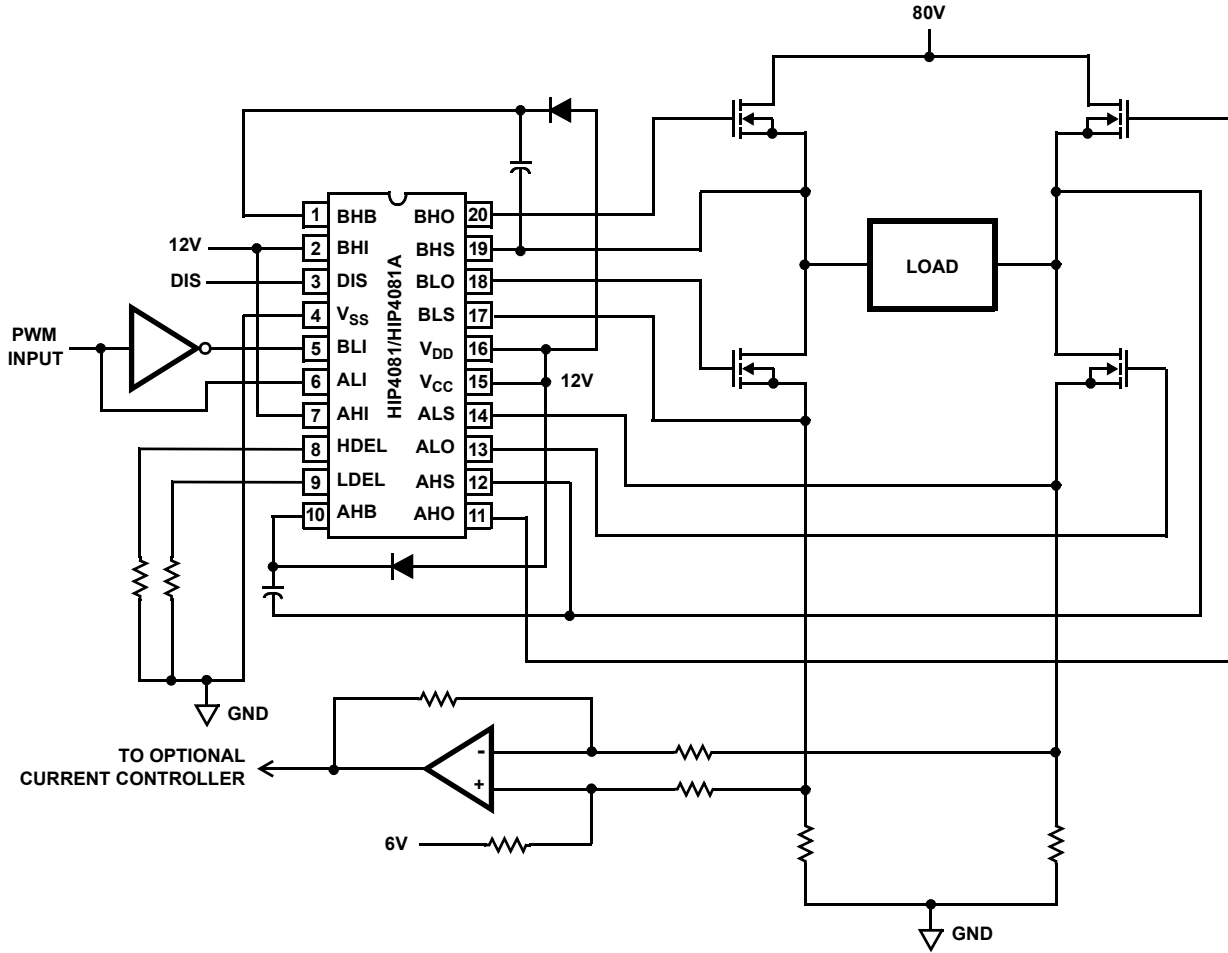

Absolute Maximum Ratings

Supply Voltage, V_{DD} and V_{CC} -0.3V to 16V
 Logic I/O Voltages -0.3V to $V_{DD} + 0.3V$
 Voltage on AHS, BHS ... -6.0V (Transient) to 80V (25°C to 125°C)
 Voltage on AHS, BHS ... -6.0V (Transient) to 70V (-55°C to 125°C)
 Voltage on ALS, BLS -2.0V (Transient) to +2.0V (Transient)
 Voltage on AHB, BHB $V_{AHS, BHS} - 0.3V$ to $V_{AHS, BHS} + V_{DD}$
 Voltage on ALO, BLO $V_{ALS, BLS} - 0.3V$ to $V_{CC} + 0.3V$
 Voltage on AHO, BHO $V_{AHS, BHS} - 0.3V$ to $V_{AHB, BHB} + 0.3V$
 Input Current, HDEL and LDEL -5mA to 0mA
 Phase Slew Rate 20V/ns
 NOTE: All Voltages relative to V_{SS} , unless otherwise specified.

Thermal Information

Thermal Resistance (Typical, Note 1) θ_{JA} (°C/W)
 SOIC Package 85
 DIP Package 75
 Storage Temperature Range -65°C to 150°C
 Operating Max. Junction Temperature 125°C
 Lead Temperature (Soldering 10s) 300°C
 (For SOIC - Lead Tips Only)

Operating Conditions

Supply Voltage, V_{DD} and V_{CC} +9.5V to +15V
 Voltage on ALS, BLS -1.0V to +1.0V
 Voltage on AHB, BHB $V_{AHS, BHS} + 5V$ to $V_{AHS, BHS} + 15V$
 Input Current, HDEL and LDEL -500µA to -50µA
 Operating Ambient Temperature Range -40°C to 85°C

CAUTION: Stresses above those listed in "Absolute Maximum Ratings" may cause permanent damage to the device. This is a stress only rating and operation of the device at these or any other conditions above those indicated in the operational sections of this specification is not implied.

NOTE:

- θ_{JA} is measured with the component mounted on an evaluation PC board in free air.

Electrical Specifications $V_{DD} = V_{CC} = V_{AHB} = V_{BHB} = 12V$, $V_{SS} = V_{ALS} = V_{BLS} = V_{AHS} = V_{BHS} = 0V$, $R_{HDEL} = R_{LDEL} = 100k\Omega$ and $T_A = 25^\circ C$, Unless Otherwise Specified

PARAMETER	SYMBOL	TEST CONDITIONS	$T_J = 25^\circ C$			$T_{JS} = -40^\circ C$ TO $125^\circ C$		UNITS
			MIN	TYP	MAX	MIN	MAX	
SUPPLY CURRENTS AND CHARGE PUMPS								
V_{DD} Quiescent Current	I_{DD}	All inputs = 0V	8.5	10.5	14.5	7.5	14.5	mA
V_{DD} Operating Current	I_{DDO}	Outputs switching $f = 500kHz$	9.5	12.5	15.5	8.5	15.5	mA
V_{CC} Quiescent Current	I_{CC}	All Inputs = 0V, $I_{ALO} = I_{BLO} = 0$	-	0.1	10	-	20	µA
V_{CC} Operating Current	I_{CCO}	$f = 500kHz$, No Load	1	1.25	2.0	0.8	3	mA
AHB, BHB Quiescent Current - Qpump Output Current	I_{AHB}, I_{BHB}	All Inputs = 0V, $I_{AHO} = I_{BHO} = 0$ $V_{DD} = V_{CC} = V_{AHB} = V_{BHB} = 10V$	-50	-30	-11	-60	-10	µA
AHB, BHB Operating Current	I_{AHBO}, I_{BHBO}	$f = 500kHz$, No Load	0.6	1.2	1.5	0.5	1.9	mA
AHS, BHS, AHB, BHB Leakage Current	I_{HLK}	$V_{BHS} = V_{AHS} = 80V$, $V_{AHB} = V_{BHB} = 93V$	-	0.02	1.0	-	10	µA
AHB-AHS, BHB-BHS Qpump Output Voltage	$V_{AHB}-V_{AHS}$ $V_{BHB}-V_{BHS}$	$I_{AHB} = I_{AHS} = 0$, No Load	11.5	12.6	14.0	10.5	14.5	V
INPUT PINS: ALI, BLI, AHI, BHI, AND DIS								
Low Level Input Voltage	V_{IL}	Full Operating Conditions	-	-	1.0	-	0.8	V
High Level Input Voltage	V_{IH}	Full Operating Conditions	2.5	-	-	2.7	-	V
Input Voltage Hysteresis			-	35	-	-	-	mV
Low Level Input Current	I_{IL}	$V_{IN} = 0V$, Full Operating Conditions	-130	-100	-75	-135	-65	µA
High Level Input Current	I_{IH}	$V_{IN} = 5V$, Full Operating Conditions	-1	-	+1	-10	+10	µA
TURN-ON DELAY PINS: LDEL AND HDEL								
LDEL, HDEL Voltage	V_{HDEL}, V_{LDEL}	$I_{HDEL} = I_{LDEL} = -100\mu A$	4.9	5.1	5.3	4.8	5.4	V
GATE DRIVER OUTPUT PINS: ALO, BLO, AHO, AND BHO								
Low Level Output Voltage	V_{OL}	$I_{OUT} = 100mA$	0.7	0.85	1.0	0.5	1.1	V
High Level Output Voltage	$V_{CC}-V_{OH}$	$I_{OUT} = -100mA$	0.8	0.95	1.1	0.5	1.2	V
Peak Pullup Current	I_{O+}	$V_{OUT} = 0V$	1.7	2.6	3.8	1.4	4.1	A

HIP4081A

Electrical Specifications $V_{DD} = V_{CC} = V_{AHB} = V_{BHB} = 12V$, $V_{SS} = V_{ALS} = V_{BLS} = V_{AHS} = V_{BHS} = 0V$, $R_{HDEL} = R_{LDEL} = 100K$ and $T_A = 25^\circ C$, Unless Otherwise Specified **(Continued)**

PARAMETER	SYMBOL	TEST CONDITIONS	$T_J = 25^\circ C$			$T_{JS} = -40^\circ C$ TO $125^\circ C$		UNITS
			MIN	TYP	MAX	MIN	MAX	
Peak Pulldown Current	I_{O-}	$V_{OUT} = 12V$	1.7	2.4	3.3	1.3	3.6	A
Undervoltage, Rising Threshold	UV+		8.1	8.8	9.4	8.0	9.5	V
Undervoltage, Falling Threshold	UV-		7.6	8.3	8.9	7.5	9.0	V
Undervoltage, Hysteresis	HYS		0.25	0.4	0.65	0.2	0.7	V

Switching Specifications $V_{DD} = V_{CC} = V_{AHB} = V_{BHB} = 12V$, $V_{SS} = V_{ALS} = V_{BLS} = V_{AHS} = V_{BHS} = 0V$, $R_{HDEL} = R_{LDEL} = 10K$, $C_L = 1000pF$.

PARAMETER	SYMBOL	TEST CONDITIONS	$T_J = 25^\circ C$			$T_{JS} = -40^\circ C$ TO $125^\circ C$		UNITS
			MIN	TYP	MAX	MIN	MAX	
Lower Turn-off Propagation Delay (ALI-ALO, BLI-BLO)	T_{LPHL}		-	30	60	-	80	ns
Upper Turn-off Propagation Delay (AHI-AHO, BHI-BHO)	T_{HPHL}		-	35	70	-	90	ns
Lower Turn-on Propagation Delay (ALI-ALO, BLI-BLO)	T_{LPLH}	$R_{HDEL} = R_{LDEL} = 10K$	-	45	70	-	90	ns
Upper Turn-on Propagation Delay (AHI-AHO, BHI-BHO)	T_{HPLH}	$R_{HDEL} = R_{LDEL} = 10K$	-	60	90	-	110	ns
Rise Time	T_R		-	10	25	-	35	ns
Fall Time	T_F		-	10	25	-	35	ns
Turn-on Input Pulse Width	$T_{PWIN-ON}$	$R_{HDEL} = R_{LDEL} = 10K$	50	-	-	50	-	ns
Turn-off Input Pulse Width	$T_{PWIN-OFF}$	$R_{HDEL} = R_{LDEL} = 10K$	40	-	-	40	-	ns
Turn-on Output Pulse Width	$T_{PWOUT-ON}$	$R_{HDEL} = R_{LDEL} = 10K$	40	-	-	40	-	ns
Turn-off Output Pulse Width	$T_{PWOUT-OFF}$	$R_{HDEL} = R_{LDEL} = 10K$	30	-	-	30	-	ns
Disable Turn-off Propagation Delay (DIS - Lower Outputs)	T_{DISLOW}		-	45	75	-	95	ns
Disable Turn-off Propagation Delay (DIS - Upper Outputs)	$T_{DISHIGH}$		-	55	85	-	105	ns
Disable to Lower Turn-on Propagation Delay (DIS - ALO and BLO)	T_{DLPLH}		-	40	70	-	90	ns
Refresh Pulse Width (ALO and BLO)	T_{REF-PW}		240	410	550	200	600	ns
Disable to Upper Enable (DIS - AHO and BHO)	T_{UEN}		-	450	620	-	690	ns

TRUTH TABLE

INPUT				OUTPUT	
ALI, BLI	AHI, BHI	U/V	DIS	ALO, BLO	AHO, BHO
X	X	X	1	0	0
1	X	0	0	1	0
0	1	0	0	0	1
0	0	0	0	0	0
X	X	1	X	0	0

NOTE: X signifies that input can be either a "1" or "0".

Pin Descriptions

PIN NUMBER	SYMBOL	DESCRIPTION
1	BHB	B High-side Bootstrap supply. External bootstrap diode and capacitor are required. Connect cathode of bootstrap diode and positive side of bootstrap capacitor to this pin. Internal charge pump supplies 30 μ A out of this pin to maintain bootstrap supply. Internal circuitry clamps the bootstrap supply to approximately 12.8V.
2	BHI	B High-side Input. Logic level input that controls BHO driver (Pin 20). BLI (Pin 5) high level input overrides BHI high level input to prevent half-bridge shoot-through, see Truth Table. DIS (Pin 3) high level input overrides BHI high level input. The pin can be driven by signal levels of 0V to 15V (no greater than V_{DD}).
3	DIS	DISable input. Logic level input that when taken high sets all four outputs low. DIS high overrides all other inputs. When DIS is taken low the outputs are controlled by the other inputs. The pin can be driven by signal levels of 0V to 15V (no greater than V_{DD}).
4	V_{SS}	Chip negative supply, generally will be ground.
5	BLI	B Low-side Input. Logic level input that controls BLO driver (Pin 18). If BHI (Pin 2) is driven high or not connected externally then BLI controls both BLO and BHO drivers, with dead time set by delay currents at HDEL and LDEL (Pin 8 and 9). DIS (Pin 3) high level input overrides BLI high level input. The pin can be driven by signal levels of 0V to 15V (no greater than V_{DD}).
6	ALI	A Low-side Input. Logic level input that controls ALO driver (Pin 13). If AHI (Pin 7) is driven high or not connected externally then ALI controls both ALO and AHO drivers, with dead time set by delay currents at HDEL and LDEL (Pin 8 and 9). DIS (Pin 3) high level input overrides ALI high level input. The pin can be driven by signal levels of 0V to 15V (no greater than V_{DD}).
7	AHI	A High-side Input. Logic level input that controls AHO driver (Pin 11). ALI (Pin 6) high level input overrides AHI high level input to prevent half-bridge shoot-through, see Truth Table. DIS (Pin 3) high level input overrides AHI high level input. The pin can be driven by signal levels of 0V to 15V (no greater than V_{DD}).
8	HDEL	High-side turn-on DELay. Connect resistor from this pin to V_{SS} to set timing current that defines the turn-on delay of both high-side drivers. The low-side drivers turn-off with no adjustable delay, so the HDEL resistor guarantees no shoot-through by delaying the turn-on of the high-side drivers. HDEL reference voltage is approximately 5.1V.
9	LDEL	Low-side turn-on DELay. Connect resistor from this pin to V_{SS} to set timing current that defines the turn-on delay of both low-side drivers. The high-side drivers turn-off with no adjustable delay, so the LDEL resistor guarantees no shoot-through by delaying the turn-on of the low-side drivers. LDEL reference voltage is approximately 5.1V.
10	AHB	A High-side Bootstrap supply. External bootstrap diode and capacitor are required. Connect cathode of bootstrap diode and positive side of bootstrap capacitor to this pin. Internal charge pump supplies 30 μ A out of this pin to maintain bootstrap supply. Internal circuitry clamps the bootstrap supply to approximately 12.8V.
11	AHO	A High-side Output. Connect to gate of A High-side power MOSFET.
12	AHS	A High-side Source connection. Connect to source of A High-side power MOSFET. Connect negative side of bootstrap capacitor to this pin.
13	ALO	A Low-side Output. Connect to gate of A Low-side power MOSFET.
14	ALS	A Low-side Source connection. Connect to source of A Low-side power MOSFET.
15	V_{CC}	Positive supply to gate drivers. Must be same potential as V_{DD} (Pin 16). Connect to anodes of two bootstrap diodes.
16	V_{DD}	Positive supply to lower gate drivers. Must be same potential as V_{CC} (Pin 15). De-couple this pin to V_{SS} (Pin 4).
17	BLS	B Low-side Source connection. Connect to source of B Low-side power MOSFET.
18	BLO	B Low-side Output. Connect to gate of B Low-side power MOSFET.
19	BHS	B High-side Source connection. Connect to source of B High-side power MOSFET. Connect negative side of bootstrap capacitor to this pin.
20	BHO	B High-side Output. Connect to gate of B High-side power MOSFET.

Timing Diagrams

X = A OR B, A AND B HALVES OF BRIDGE CONTROLLER ARE INDEPENDENT

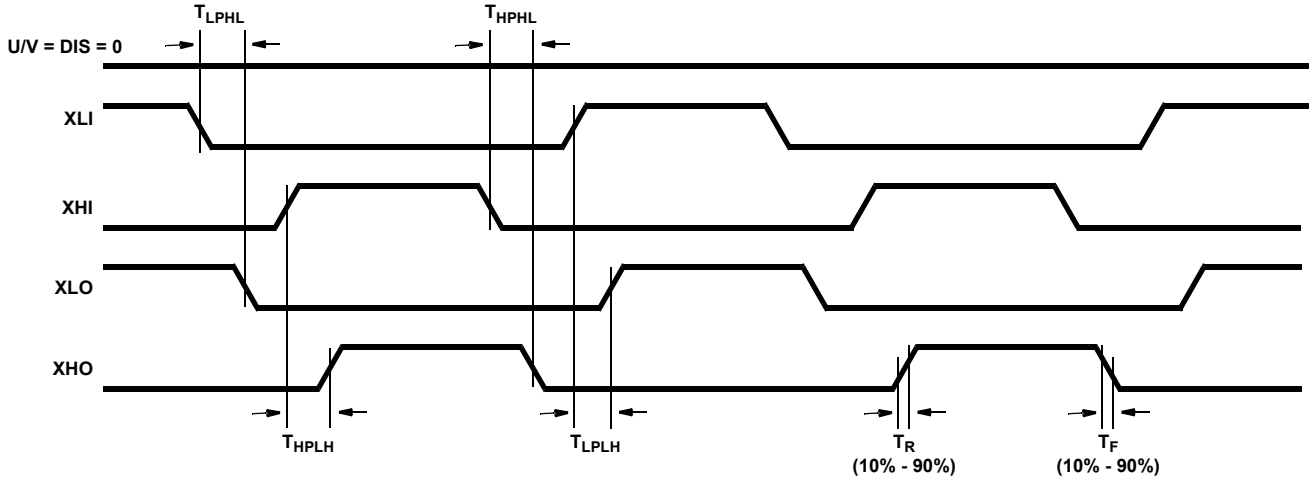

FIGURE 1. INDEPENDENT MODE

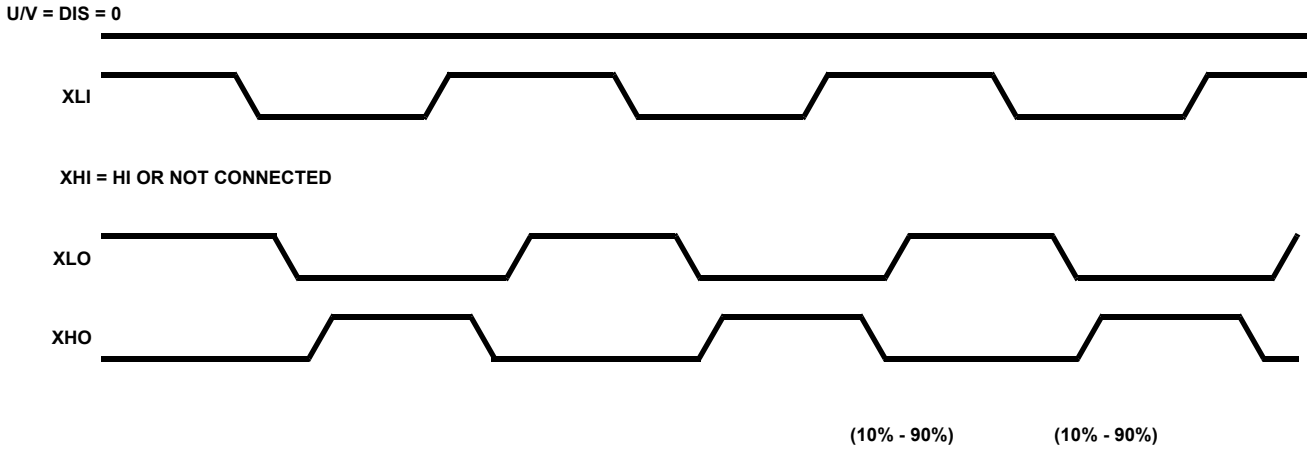

FIGURE 2. BISTATE MODE

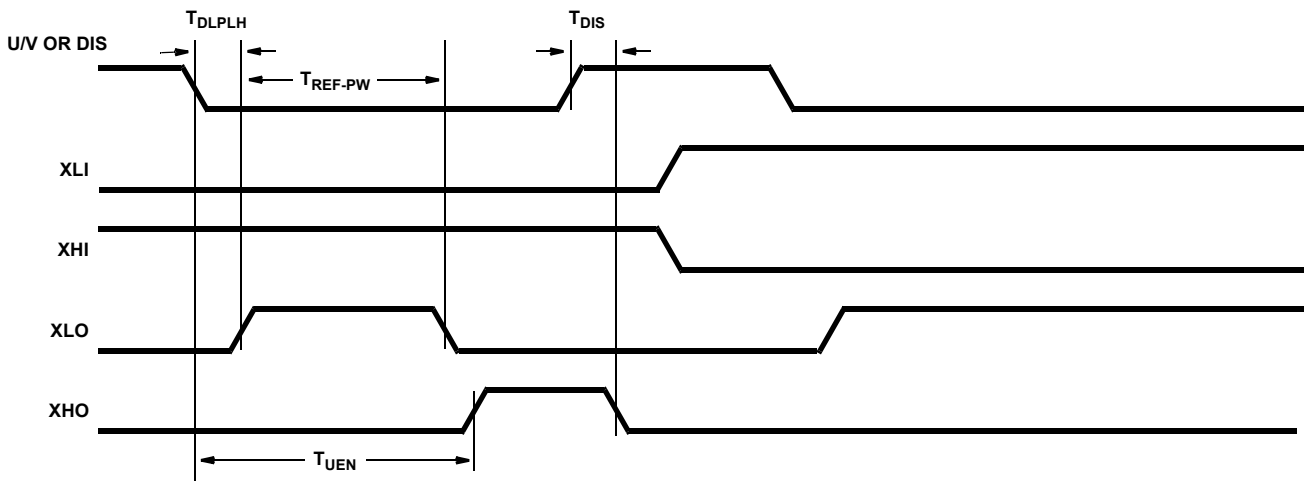

FIGURE 3. DISABLE FUNCTION

Typical Performance Curves $V_{DD} = V_{CC} = V_{AHB} = V_{BHB} = 12V$, $V_{SS} = V_{ALS} = V_{BLS} = V_{AHS} = V_{BHS} = 0V$, $R_{HDEL} = R_{LDEL} = 100k$ and $T_A = 25^\circ C$, Unless Otherwise Specified

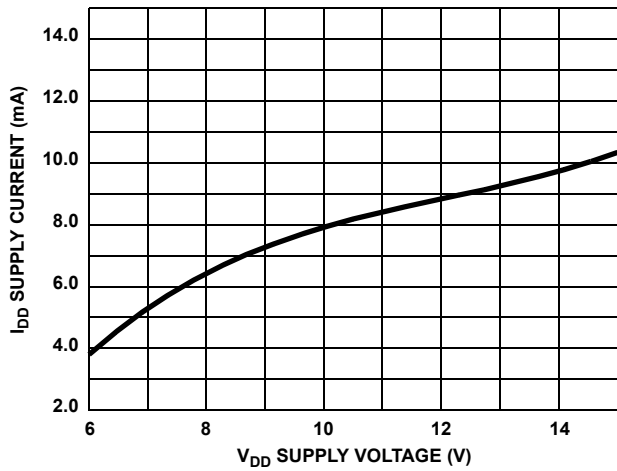

FIGURE 4. QUIESCENT I_{DD} SUPPLY CURRENT vs V_{DD} SUPPLY VOLTAGE

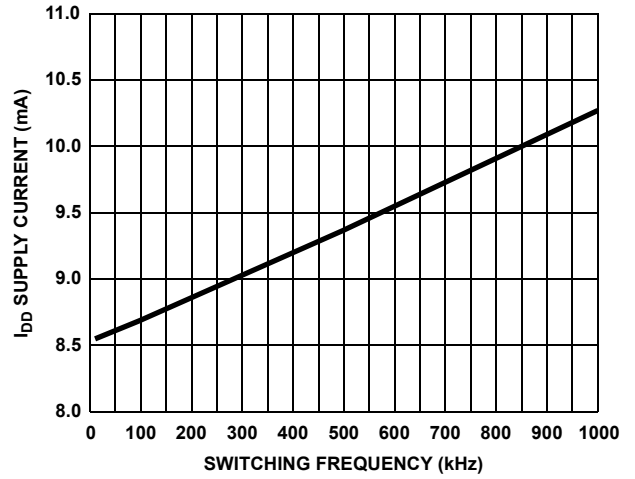

FIGURE 5. I_{DD0}, NO-LOAD I_{DD} SUPPLY CURRENT vs FREQUENCY (kHz)

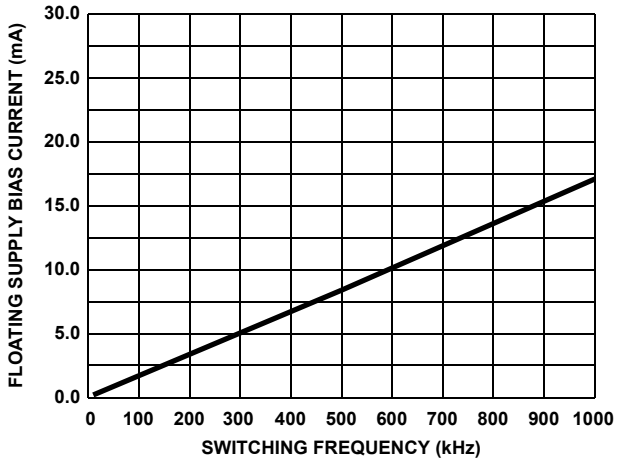

FIGURE 6. SIDE A, B FLOATING SUPPLY BIAS CURRENT vs FREQUENCY (LOAD = 1000pF)

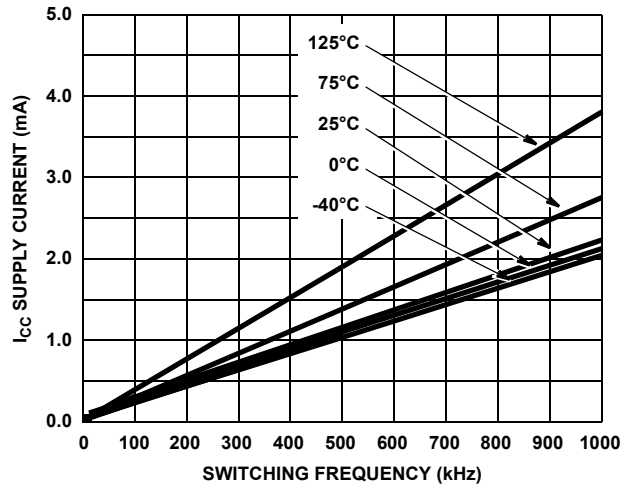

FIGURE 7. I_{CC0}, NO-LOAD I_{CC} SUPPLY CURRENT vs FREQUENCY (kHz) TEMPERATURE

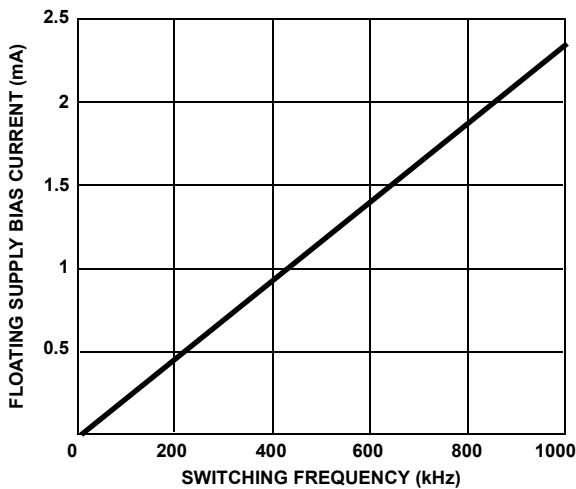

FIGURE 8. I_{AHB}, I_{BHB}, NO-LOAD FLOATING SUPPLY BIAS CURRENT vs FREQUENCY

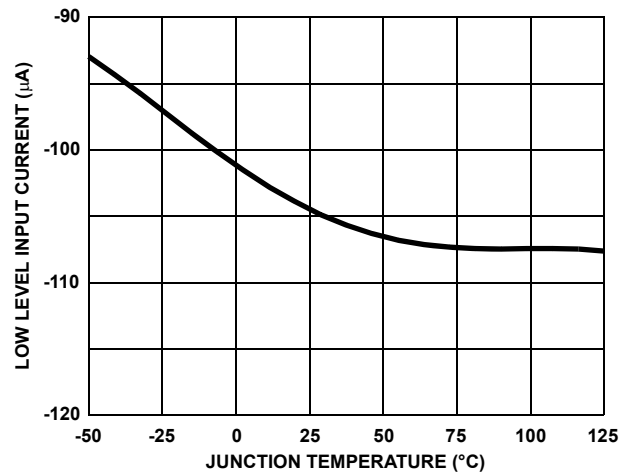

FIGURE 9. ALI, BLI, AHI, BHI LOW LEVEL INPUT CURRENT I_{IL} vs TEMPERATURE

Typical Performance Curves $V_{DD} = V_{CC} = V_{AHB} = V_{BHB} = 12V$, $V_{SS} = V_{ALS} = V_{BLS} = V_{AHS} = V_{BHS} = 0V$, $R_{HDEL} = R_{LDEL} = 10K$ and $T_A = 25^\circ C$, Unless Otherwise Specified

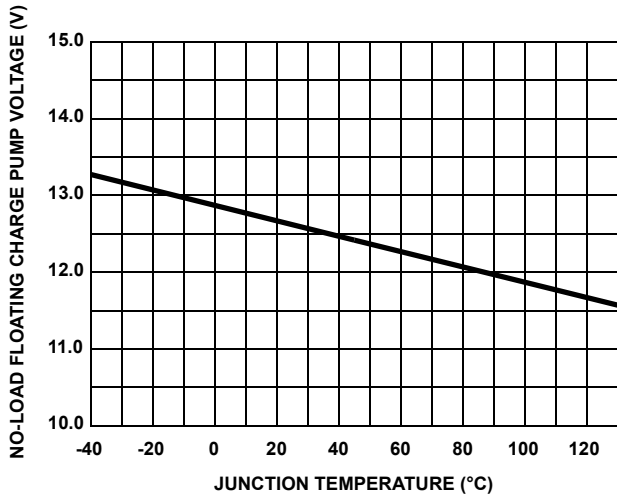

FIGURE 10. AHB - AHS, BHB - BHS NO-LOAD CHARGE PUMP VOLTAGE vs TEMPERATURE

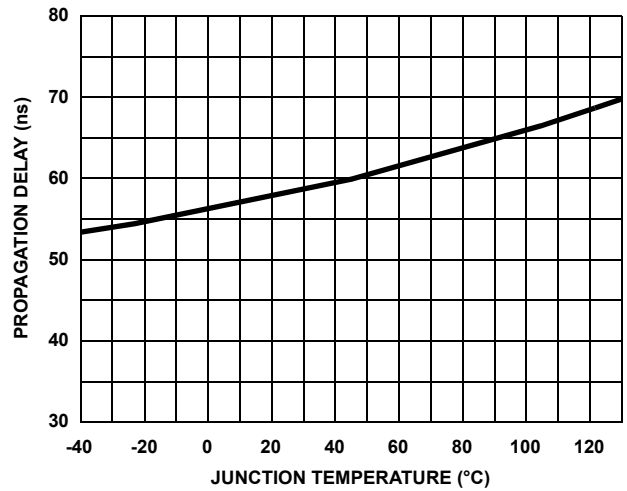

FIGURE 11. UPPER DISABLE TURN-OFF PROPAGATION DELAY $T_{DISHIGH}$ vs TEMPERATURE

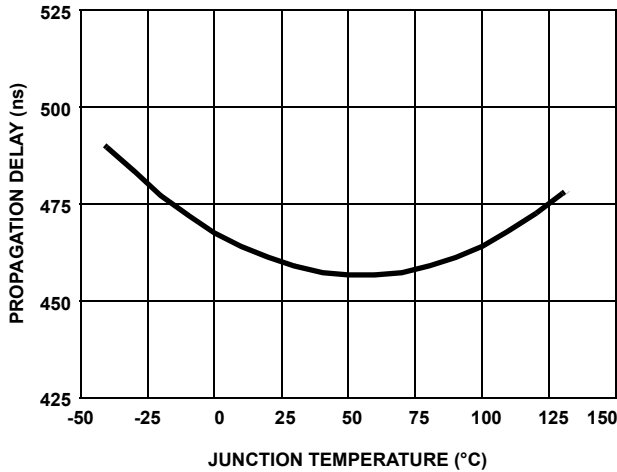

FIGURE 12. DISABLE TO UPPER ENABLE, T_{UEN} , PROPAGATION DELAY vs TEMPERATURE

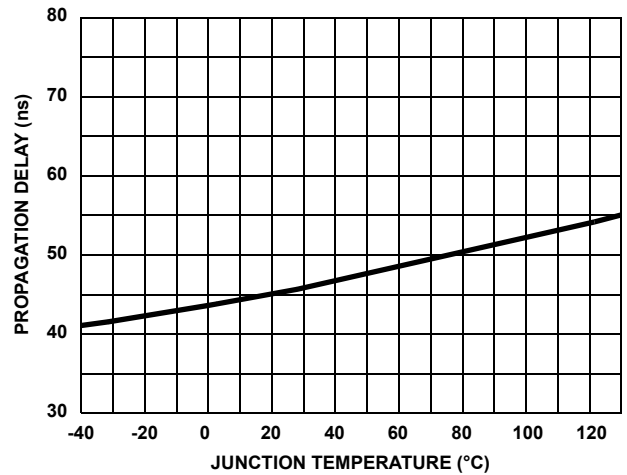

FIGURE 13. LOWER DISABLE TURN-OFF PROPAGATION DELAY T_{DISLOW} vs TEMPERATURE

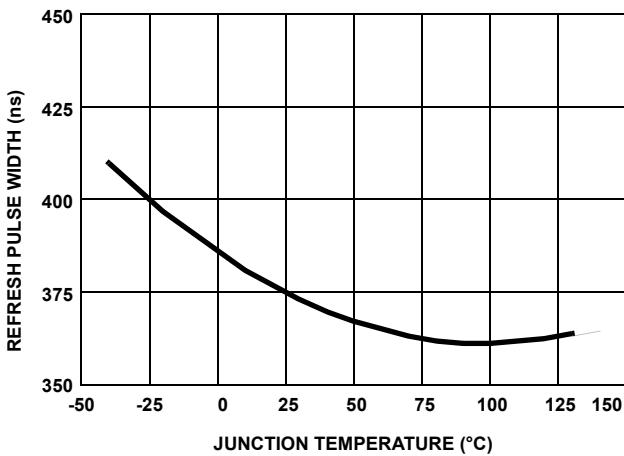

FIGURE 14. T_{REF-PW} REFRESH PULSE WIDTH vs TEMPERATURE

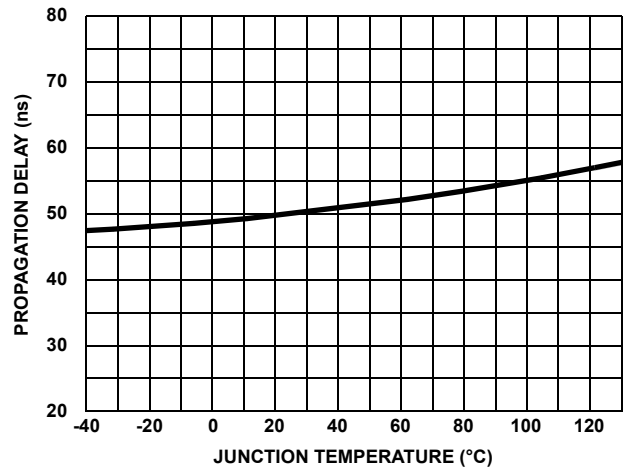

FIGURE 15. DISABLE TO LOWER ENABLE T_{DLPLH} PROPAGATION DELAY vs TEMPERATURE

Typical Performance Curves $V_{DD} = V_{CC} = V_{AHB} = V_{BHB} = 12V$, $V_{SS} = V_{ALS} = V_{BLS} = V_{AHS} = V_{BHS} = 0V$, $R_{HDEL} = R_{LDEL} = 10K$ and $T_A = 25^\circ C$, Unless Otherwise Specified **(Continued)**

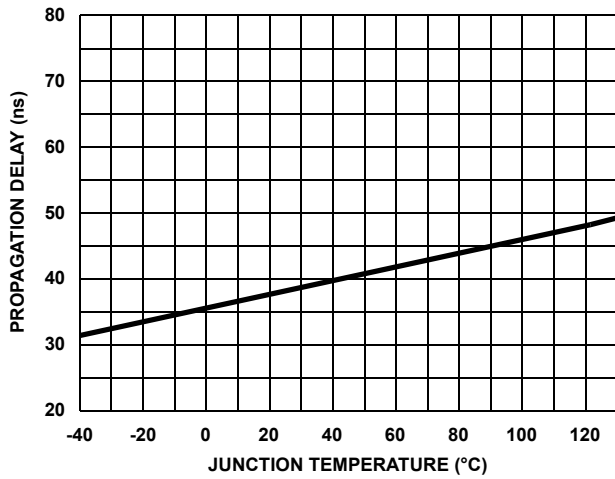

FIGURE 16. UPPER TURN-OFF PROPAGATION DELAY T_{HPLH} vs TEMPERATURE

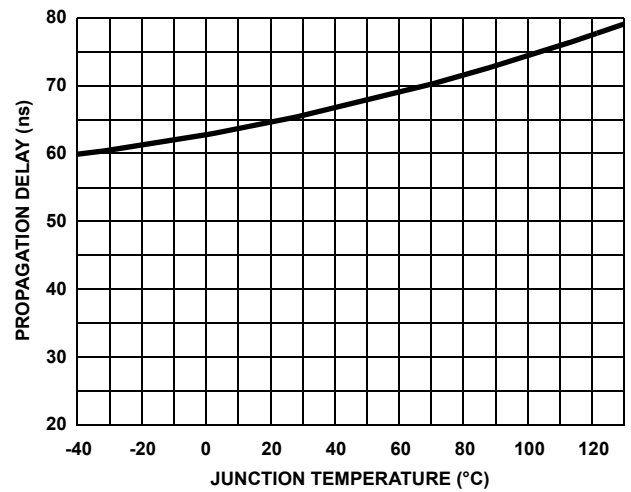

FIGURE 17. UPPER TURN-ON PROPAGATION DELAY T_{HPLH} vs TEMPERATURE

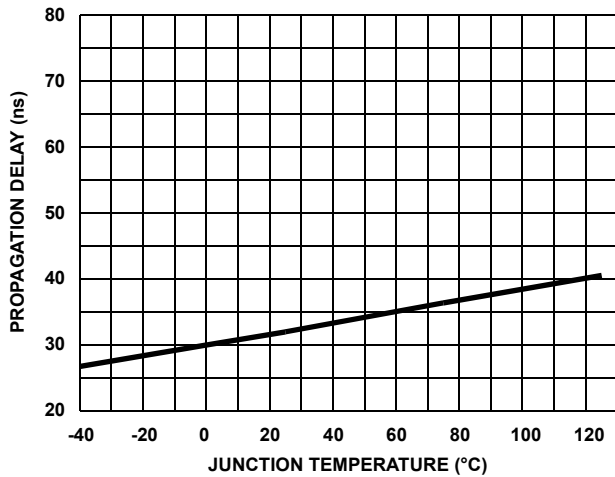

FIGURE 18. LOWER TURN-OFF PROPAGATION DELAY T_{LPLH} vs TEMPERATURE

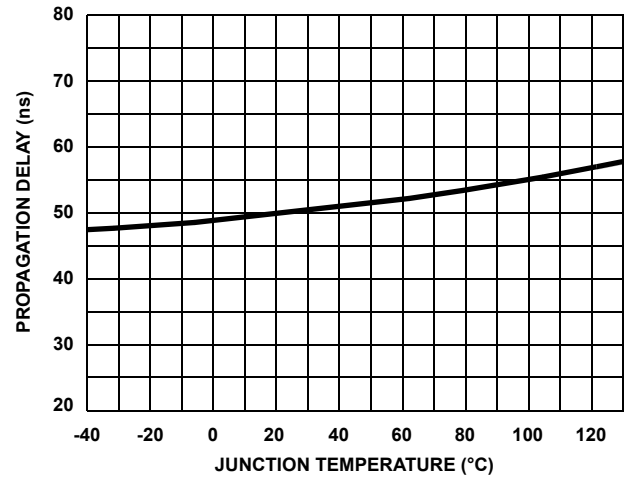

FIGURE 19. LOWER TURN-ON PROPAGATION DELAY T_{LPLH} vs TEMPERATURE

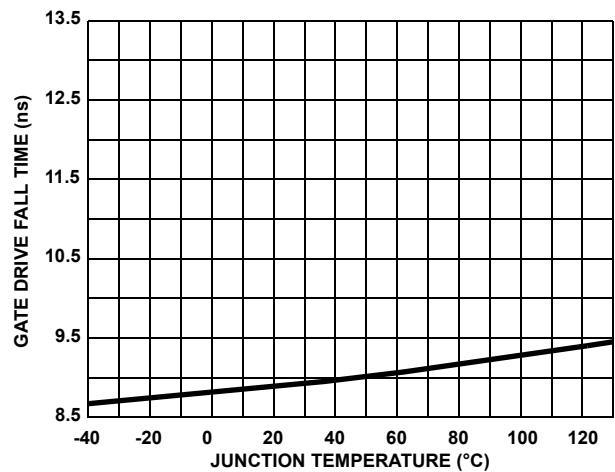

FIGURE 20. GATE DRIVE FALL TIME T_F vs TEMPERATURE

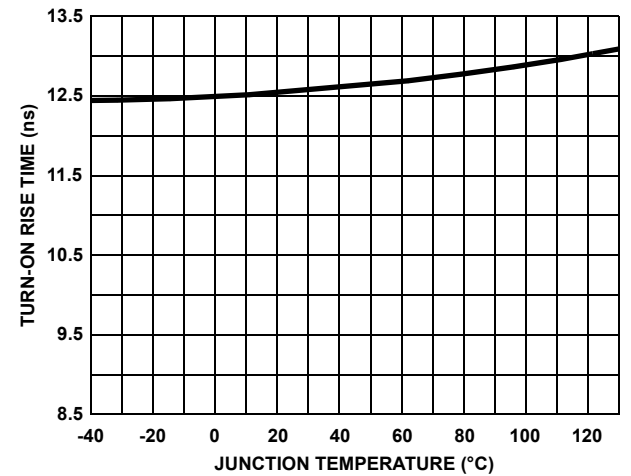

FIGURE 21. GATE DRIVE RISE TIME T_R vs TEMPERATURE

Typical Performance Curves $V_{DD} = V_{CC} = V_{AHB} = V_{BHB} = 12V$, $V_{SS} = V_{ALS} = V_{BLS} = V_{AHS} = V_{BHS} = 0V$, $R_{HDEL} = R_{LDEL} = 100K$ and $T_A = 25^\circ C$, Unless Otherwise Specified

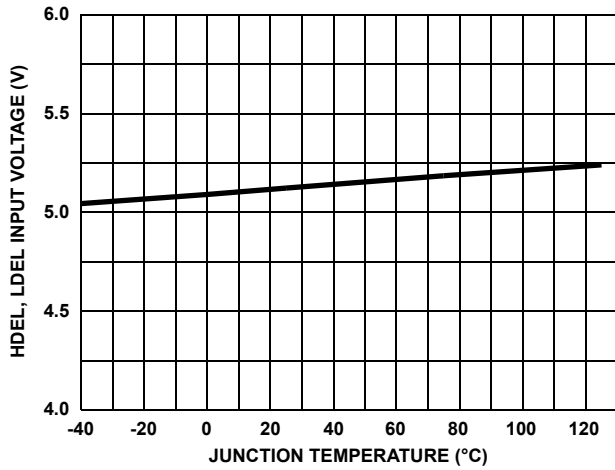

FIGURE 22. V_{LDEL} , V_{HDEL} VOLTAGE vs TEMPERATURE

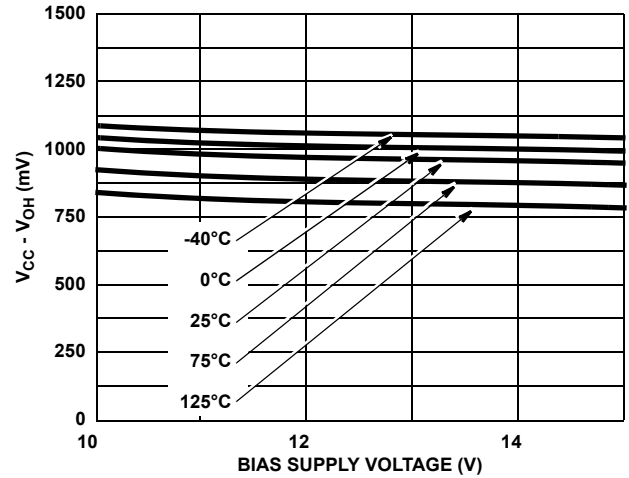

FIGURE 23. HIGH LEVEL OUTPUT VOLTAGE $V_{CC} - V_{OH}$ vs BIAS SUPPLY AND TEMPERATURE AT 100mA

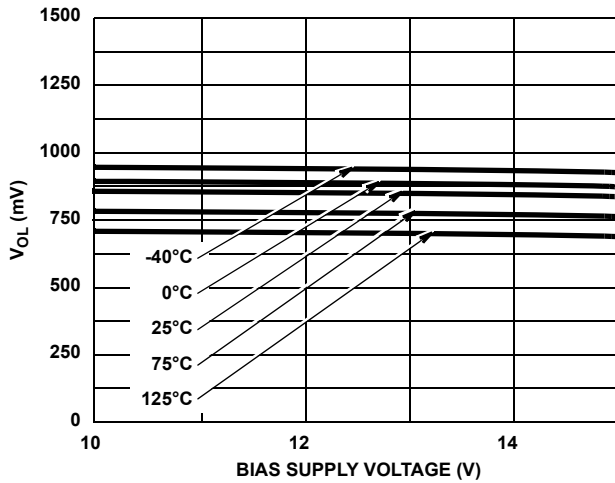

FIGURE 24. LOW LEVEL OUTPUT VOLTAGE V_{OL} vs BIAS SUPPLY AND TEMPERATURE AT 100mA

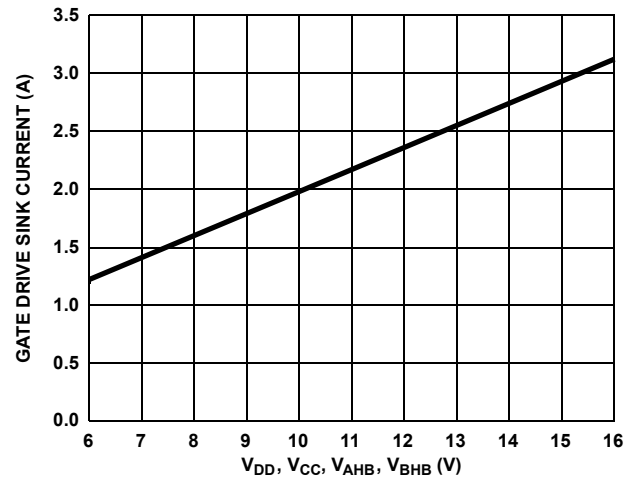

FIGURE 25. PEAK PULLDOWN CURRENT I_O vs BIAS SUPPLY VOLTAGE

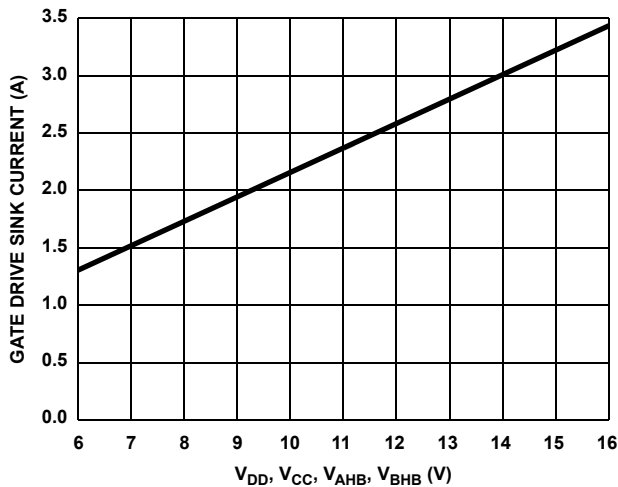

FIGURE 26. PEAK PULLUP CURRENT I_{O+} vs BIAS SUPPLY VOLTAGE

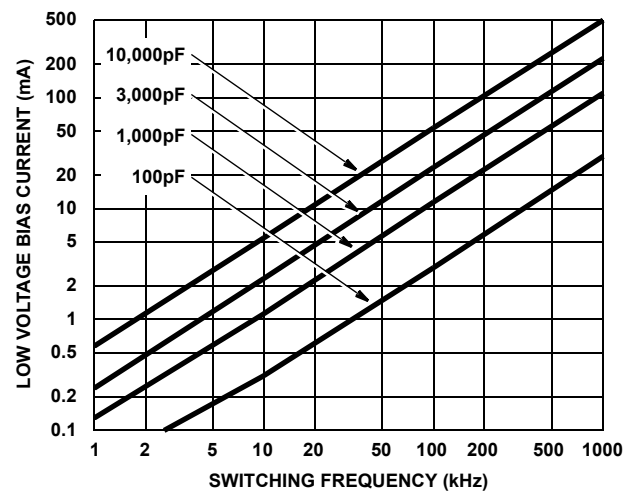

FIGURE 27. LOW VOLTAGE BIAS CURRENT I_{DD} (LESS QUIESCENT COMPONENT) vs FREQUENCY AND GATE LOAD CAPACITANCE

Typical Performance Curves $V_{DD} = V_{CC} = V_{AHB} = V_{BHB} = 12V$, $V_{SS} = V_{ALS} = V_{BLS} = V_{AHS} = V_{BHS} = 0V$, $R_{HDEL} = R_{LDEL} = 100K$ and $T_A = 25^\circ C$, Unless Otherwise Specified **(Continued)**

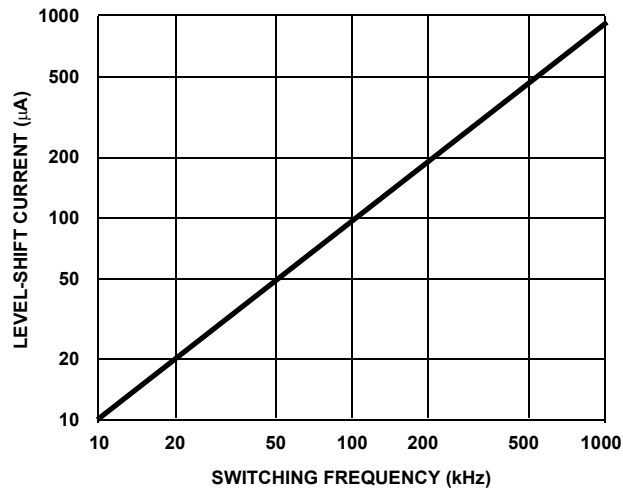

FIGURE 28. HIGH VOLTAGE LEVEL-SHIFT CURRENT vs FREQUENCY AND BUS VOLTAGE

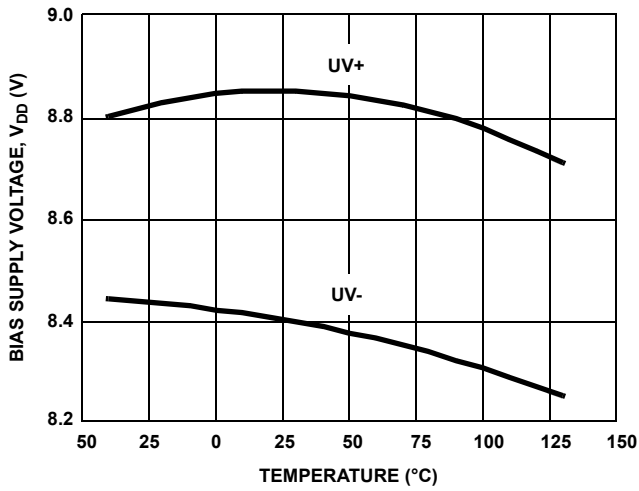

FIGURE 29. UNDERVOLTAGE LOCKOUT vs TEMPERATURE

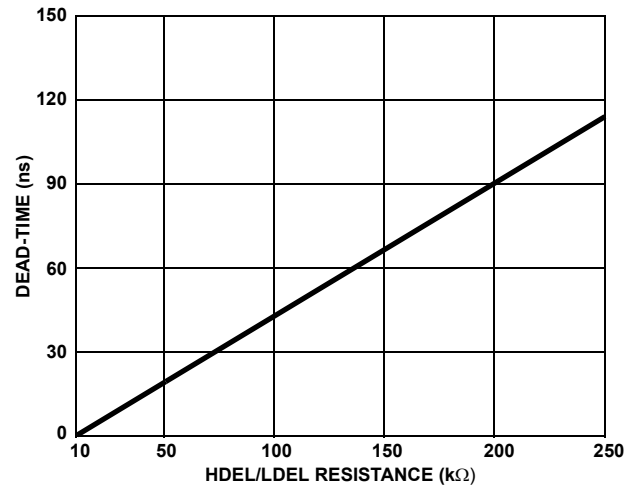

FIGURE 30. MINIMUM DEAD-TIME vs DEL RESISTANCE

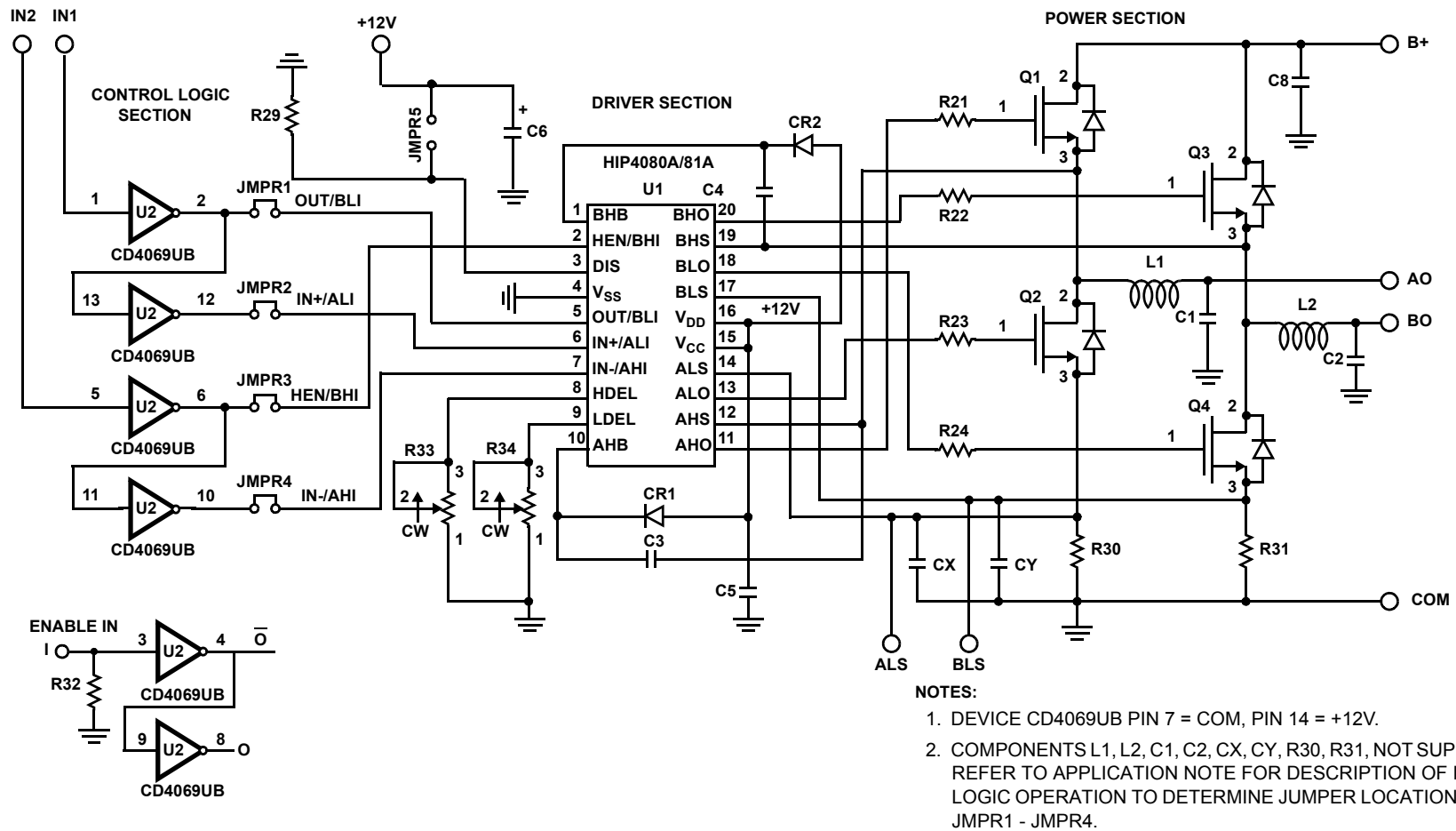

FIGURE 31. HIP4081A EVALUATION PC BOARD SCHEMATIC

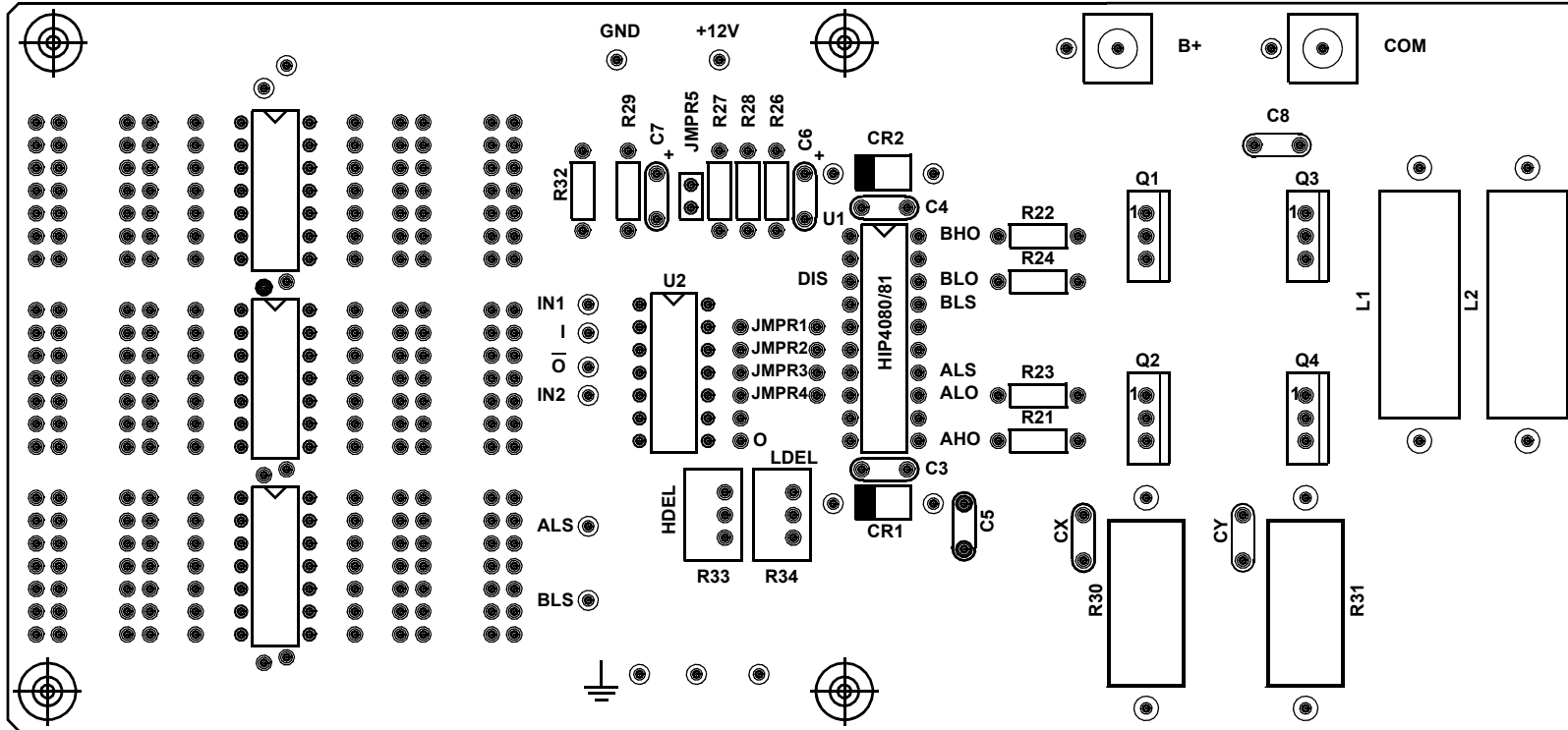

FIGURE 32. HIP4081A EVALUATION BOARD SILKSCREEN

Revision History

The revision history provided is for informational purposes only and is believed to be accurate, but not warranted. Please go to the web to make sure that you have the latest revision.

DATE	REVISION	CHANGE
September 15, 2015	FN3659.8	Updated Ordering Information Table on page 1. Added Revision History and About Intersil sections. Updated POD M20.3 from rev 1 to rev 3. Changes since rev 1: Top View: Corrected "7.50 BSC" to "7.60/7.40" (no change from rev 2; error was introduced in conversion) Changed "10.30 BSC" to "10.65/10.00" (no change from rev 2; error was introduced in conversion) Side View: Changed "12.80 BSC" to "13.00/12.60" (no change from rev 2; error was introduced in conversion) Changed "2.65 max" to "2.65/2.35" (no change from rev 2; error was introduced in conversion) Changed Note 1 from "ANSI Y14.5M-1982." to "ASME Y14.5M-1994" Updated to new POD format by moving dimensions from table onto drawing and adding land pattern

About Intersil

Intersil Corporation is a leading provider of innovative power management and precision analog solutions. The company's products address some of the largest markets within the industrial and infrastructure, mobile computing and high-end consumer markets.

For the most updated datasheet, application notes, related documentation and related parts, please see the respective product information page found at www.intersil.com.

You may report errors or suggestions for improving this datasheet by visiting www.intersil.com/ask.

Reliability reports are also available from our website at www.intersil.com/support

Dual-In-Line Plastic Packages (PDIP)

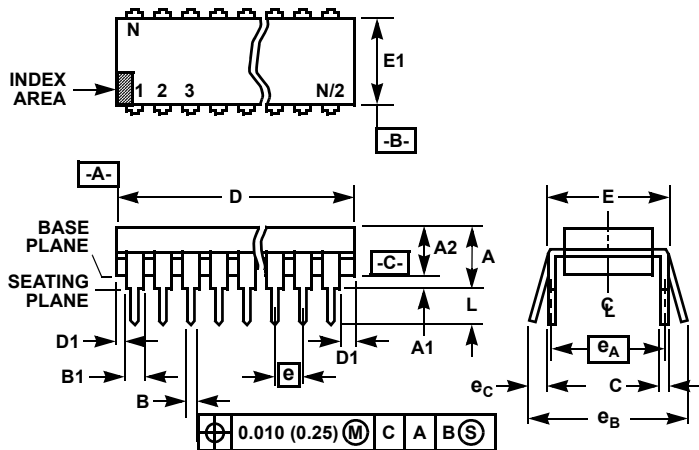

NOTES:

- Controlling Dimensions: INCH. In case of conflict between English and Metric dimensions, the inch dimensions control.
- Dimensioning and tolerancing per ANSI Y14.5M-1982.
- Symbols are defined in the "MO Series Symbol List" in Section 2.2 of Publication No. 95.
- Dimensions A, A1 and L are measured with the package seated in JEDEC seating plane gauge GS-3.
- D, D1, and E1 dimensions do not include mold flash or protrusions. Mold flash or protrusions shall not exceed 0.010 inch (0.25mm).
- E and e_A are measured with the leads constrained to be perpendicular to datum $-C-$.
- e_B and e_C are measured at the lead tips with the leads unconstrained. e_C must be zero or greater.
- B1 maximum dimensions do not include dambar protrusions. Dambar protrusions shall not exceed 0.010 inch (0.25mm).
- N is the maximum number of terminal positions.
- Corner leads (1, N, N/2 and N/2 + 1) for E8.3, E16.3, E18.3, E28.3, E42.6 will have a B1 dimension of 0.030 - 0.045 inch (0.76 - 1.14mm).

E20.3 (JEDEC MS-001-AD ISSUE D)
20 LEAD DUAL-IN-LINE PLASTIC PACKAGE

SYMBOL	INCHES		MILLIMETERS		NOTES
	MIN	MAX	MIN	MAX	
A	-	0.210	-	5.33	4
A1	0.015	-	0.39	-	4
A2	0.115	0.195	2.93	4.95	-
B	0.014	0.022	0.356	0.558	-
B1	0.045	0.070	1.55	1.77	8
C	0.008	0.014	0.204	0.355	-
D	0.980	1.060	24.89	26.9	5
D1	0.005	-	0.13	-	5
E	0.300	0.325	7.62	8.25	6
E1	0.240	0.280	6.10	7.11	5
e	0.100 BSC		2.54 BSC		-
e_A	0.300 BSC		7.62 BSC		6
e_B	-	0.430	-	10.92	7
L	0.115	0.150	2.93	3.81	4
N	20		20		9

Rev. 0 12/93

All Intersil U.S. products are manufactured, assembled and tested utilizing ISO9001 quality systems.
Intersil Corporation's quality certifications can be viewed at www.intersil.com/design/quality

Intersil products are sold by description only. Intersil Corporation reserves the right to make changes in circuit design, software and/or specifications at any time without notice. Accordingly, the reader is cautioned to verify that data sheets are current before placing orders. Information furnished by Intersil is believed to be accurate and reliable. However, no responsibility is assumed by Intersil or its subsidiaries for its use; nor for any infringements of patents or other rights of third parties which may result from its use. No license is granted by implication or otherwise under any patent or patent rights of Intersil or its subsidiaries.

For information regarding Intersil Corporation and its products, see www.intersil.com

Package Outline Drawing

M20.3

20 LEAD WIDE BODY SMALL OUTLINE PLASTIC PACKAGE (SOIC)

Rev 3, 2/11

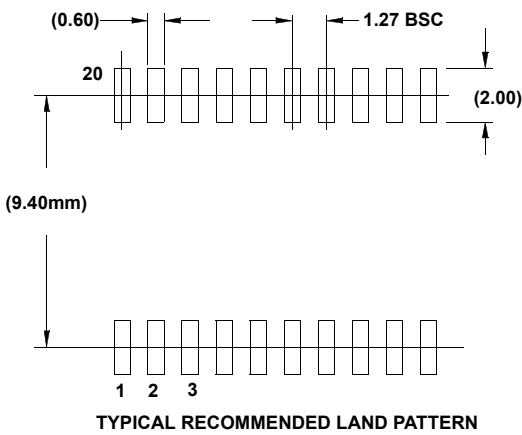
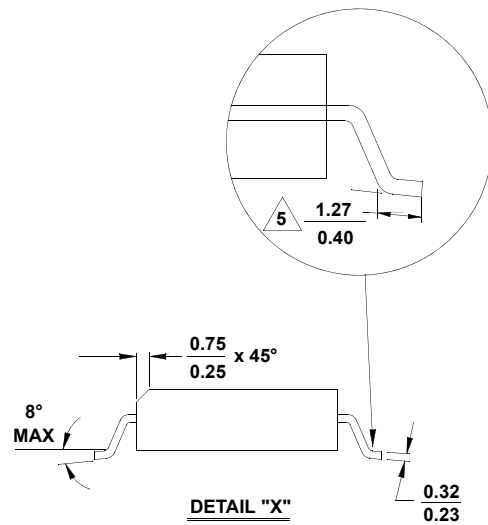
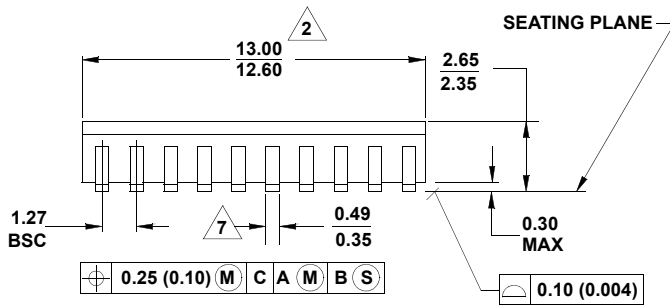
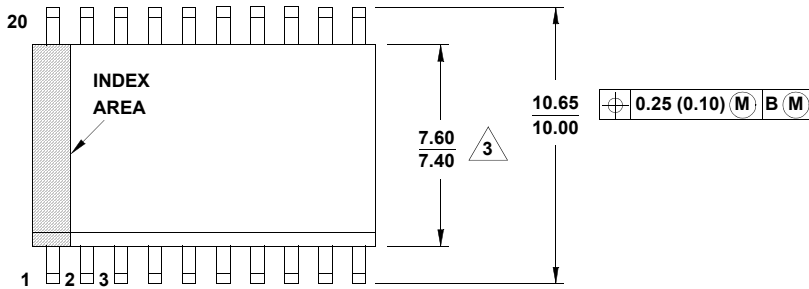

NOTES:

1. Dimensioning and tolerancing per ASME Y14.5M-1994.
2. Dimension does not include mold flash, protrusions or gate burrs. Mold flash, protrusion and gate burrs shall not exceed 0.15mm (0.006 inch) per side.
3. Dimension does not include interlead lash or protrusions. Interlead flash and protrusions shall not exceed 0.25mm (0.010 inch) per side.
4. The chamfer on the body is optional. If it is not present, a visual index feature must be located within the crosshatched area.
5. Dimension is the length of terminal for soldering to a substrate.
6. Terminal numbers are shown for reference only.
7. The lead width as measured 0.36mm (0.14 inch) or greater above the seating plane, shall not exceed a maximum value of 0.61mm (0.024 inch)
8. Controlling dimension: MILLIMETER.
9. Dimensions in () for reference only.
10. JEDEC reference drawing number: MS-013-AC.