

Silicon NPN Planar RF Transistor

Electrostatic sensitive device.
Observe precautions for handling.



Applications

Low noise small signal amplifiers up to 2 GHz. This transistor has superior noise figure and associated gain performance at UHF, VHF and microwave frequencies.

Features

- Small feedback capacitance
- Low noise figure
- High transition frequency

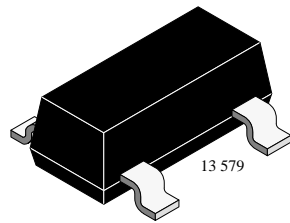
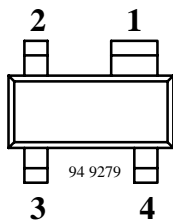

BFP67 Marking: 67
Plastic case (SOT 143)
1 = Collector, 2 = Emitter, 3 = Base, 4 = Emitter

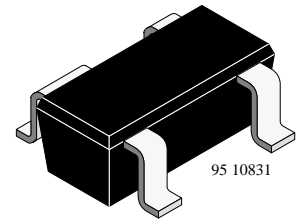
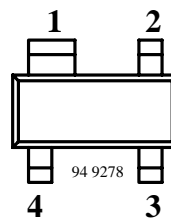

BFP67R Marking: 67R
Plastic case (SOT 143R)
1 = Collector, 2 = Emitter, 3 = Base, 4 = Emitter

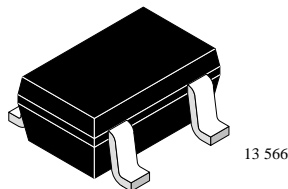
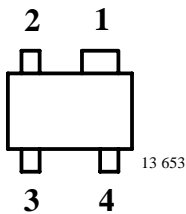

BFP67W Marking: W67
Plastic case (SOT 343)
1 = Collector, 2 = Emitter, 3 = Base, 4 = Emitter

Absolute Maximum Ratings

$T_{amb} = 25^{\circ}\text{C}$, unless otherwise specified

Parameter	Test Conditions	Symbol	Value	Unit
Collector-base voltage		V_{CBO}	20	V
Collector-emitter voltage		V_{CEO}	10	V
Emitter-base voltage		V_{EBO}	2.5	V
Collector current		I_C	50	mA
Total power dissipation	$T_{amb} \leq 60^{\circ}\text{C}$	P_{tot}	200	mW
Junction temperature		T_j	150	$^{\circ}\text{C}$
Storage temperature range		T_{stg}	-65 to +150	$^{\circ}\text{C}$

Maximum Thermal Resistance

$T_{amb} = 25^{\circ}\text{C}$, unless otherwise specified

Parameter	Test Conditions	Symbol	Value	Unit
Junction ambient	on glass fibre printed board (25 x 20 x 1.5) mm ³ plated with 35µm Cu	R_{thJA}	450	K/W

Electrical DC Characteristics

$T_{amb} = 25^{\circ}\text{C}$, unless otherwise specified

Parameter	Test Conditions	Symbol	Min	Typ	Max	Unit
Collector cut-off current	$V_{CE} = 20\text{ V}$, $V_{BE} = 0$	I_{CES}			100	µA
Collector-base cut-off current	$V_{CB} = 15\text{ V}$, $I_E = 0$	I_{CBO}			100	nA
Emitter-base cut-off current	$V_{EB} = 1\text{ V}$, $I_C = 0$	I_{EBO}			1	µA
Collector-emitter breakdown voltage	$I_C = 1\text{ mA}$, $I_B = 0$	$V_{(BR)CEO}$	10			V
Collector-emitter saturation voltage	$I_C = 50\text{ mA}$, $I_B = 5\text{ mA}$	V_{CEsat}		0.1	0.4	V
DC forward current transfer ratio	$V_{CE} = 5\text{ V}$, $I_C = 15\text{ mA}$	h_{FE}	65	100	150	

Electrical AC Characteristics

$T_{amb} = 25^{\circ}\text{C}$, unless otherwise specified

Parameter	Test Conditions	Symbol	Min	Typ	Max	Unit
Transition frequency	$V_{CE} = 8\text{ V}$, $I_C = 15\text{ mA}$, $f = 500\text{ MHz}$	f_T		7.5		GHz
Collector-base capacitance	$V_{CB} = 10\text{ V}$, $f = 1\text{ MHz}$	C_{cb}		0.35		pF
Collector-emitter capacitance	$V_{CE} = 8\text{ V}$, $f = 1\text{ MHz}$	C_{ce}		0.25		pF
Emitter-base capacitance	$V_{EB} = 0.5\text{ V}$, $f = 1\text{ MHz}$	C_{eb}		0.85		pF
Noise figure	$V_{CE} = 8\text{ V}$, $Z_S = Z_{Sopt}$, $f = 800\text{ MHz}$, $I_C = 5\text{ mA}$	F		0.8		dB
	$V_{CE} = 8\text{ V}$, $Z_S = Z_{Sopt}$, $f = 800\text{ MHz}$, $I_C = 15\text{ mA}$	F		1.5		dB
	$V_{CE} = 8\text{ V}$, $Z_S = 50\ \Omega$, $f = 2\text{ GHz}$, $I_C = 5\text{ mA}$	F		2.5		dB
	$V_{CE} = 8\text{ V}$, $Z_S = 50\ \Omega$, $f = 2\text{ GHz}$, $I_C = 15\text{ mA}$	F		3.0		dB
Power gain	$V_{CE} = 8\text{ V}$, $Z_S = 50\ \Omega$, $Z_L = Z_{Lopt}$, $I_C = 15\text{ mA}$, $f = 800\text{ MHz}$	G_{pe}		18		dB
	$V_{CE} = 8\text{ V}$, $Z_S = 50\ \Omega$, $Z_L = Z_{Lopt}$, $I_C = 15\text{ mA}$, $f = 2\text{ GHz}$	G_{pe}		10		dB
Linear output voltage – two tone intermodulation test	$V_{CE} = 8\text{ V}$, $I_C = 15\text{ mA}$, $d_{IM} = 60\text{ dB}$, $f_1 = 806\text{ MHz}$, $f_2 = 810\text{ MHz}$, $Z_S = Z_L = 50\ \Omega$	$V_1 = V_2$		160		mV
Third order intercept point	$V_{CE} = 8\text{ V}$, $I_C = 15\text{ mA}$, $f = 800\text{ MHz}$	IP_3		26		dBm



Common Emitter S-Parameters

$Z_0 = 50 \Omega$, $T_{amb} = 25^\circ C$, unless otherwise specified

V_{CE}/V	I_C/mA	f/MHz	S11		S21		S12		S22		
			LIN MAG	ANG	LIN MAG	ANG	LIN MAG	ANG	LIN MAG	ANG	
				deg		deg		deg		deg	
5	2	100	0.923	-18.5	6.55	165.3	0.023	77.7	0.971	-7.9	
		300	0.828	-52.3	5.71	141.2	0.060	58.8	0.877	-19.9	
		500	0.721	-79.4	4.77	122.9	0.082	45.9	0.772	-27.2	
		800	0.622	-110.7	3.72	103.5	0.099	34.2	0.670	-33.4	
		1000	0.582	-127.9	3.19	93.5	0.105	29.5	0.629	-36.4	
		1200	0.558	-142.8	2.81	84.7	0.108	25.8	0.598	-39.3	
		1500	0.546	-163.0	2.38	72.7	0.110	21.9	0.569	-44.0	
		1800	0.554	179.4	2.07	61.9	0.109	20.0	0.549	-48.7	
		2000	0.566	169.1	1.90	55.4	0.108	19.7	0.539	-52.1	
		2200	0.609	159.1	1.78	48.8	0.107	20.4	0.537	-56.0	
		2500	0.634	147.9	1.60	40.2	0.111	20.4	0.530	-61.9	
		2800	0.677	138.5	1.47	32.1	0.109	21.8	0.547	-69.2	
	3000	0.707	133.4	1.36	24.9	0.109	22.0	0.530	-75.0		
	5	5	100	0.824	-28.9	14.21	158.8	0.021	73.5	0.931	-13.8
			300	0.672	-77.3	10.83	128.8	0.048	52.5	0.727	-30.1
			500	0.564	-109.0	8.05	110.6	0.060	43.8	0.580	-35.7
			800	0.496	-139.6	5.66	93.7	0.071	39.7	0.478	-37.8
			1000	0.477	-155.2	4.68	85.4	0.077	38.9	0.446	-39.2
			1200	0.471	-167.9	4.03	78.2	0.082	38.7	0.425	-40.9
			1500	0.482	176.1	3.32	68.1	0.090	38.6	0.405	-44.7
			1800	0.502	162.1	2.83	59.0	0.098	38.8	0.391	-49.1
			2000	0.526	154.2	2.59	53.3	0.103	38.7	0.386	-52.7
			2200	0.565	146.0	2.41	47.5	0.109	38.8	0.383	-56.7
			2500	0.596	137.7	2.14	39.9	0.118	36.7	0.374	-63.2
			2800	0.642	130.3	1.96	32.5	0.125	36.2	0.385	-70.9
	3000	0.669	126.2	1.81	26.3	0.128	34.8	0.369	-77.1		
	10	10	100	0.689	-43.7	23.32	151.2	0.019	68.4	0.872	-20.7
			300	0.544	-103.8	14.92	118.0	0.037	50.7	0.575	-38.0
			500	0.481	-135.0	10.12	102.0	0.047	47.7	0.432	-39.6
			800	0.450	-161.2	6.77	87.8	0.058	48.9	0.357	-38.1
			1000	0.446	-173.3	5.51	80.6	0.066	50.2	0.338	-38.2
			1200	0.447	176.2	4.69	74.4	0.074	50.4	0.325	-39.6
			1500	0.461	163.5	3.83	65.5	0.087	50.1	0.314	-43.5
1800			0.490	152.5	3.24	57.3	0.098	49.2	0.304	-48.4	
2000			0.511	145.7	2.95	52.0	0.107	48.2	0.301	-52.4	
2200			0.552	138.7	2.74	46.6	0.115	47.0	0.298	-57.2	
2500			0.588	132.2	2.44	39.6	0.126	43.4	0.288	-64.4	
2800			0.626	126.1	2.23	32.6	0.135	41.8	0.299	-72.9	
3000	0.659	122.6	2.04	27.1	0.138	39.8	0.282	-79.8			

V _{CE} /V	I _C /mA	f/MHz	S11		S21		S12		S22	
			LIN MAG	ANG	LIN MAG	ANG	LIN MAG	ANG	LIN MAG	ANG
				deg		deg		deg		deg
5	15	100	0.598	-55.4	29.27	146.1	0.017	67.0	0.820	-25.1
		300	0.494	-120.4	16.71	112.4	0.032	52.0	0.492	-40.9
		500	0.458	-148.6	10.93	98.1	0.041	52.3	0.364	-40.1
		800	0.440	-170.9	7.19	85.1	0.054	55.1	0.306	-36.7
		1000	0.439	178.4	5.83	78.7	0.063	55.8	0.294	-36.6
		1200	0.446	169.6	4.94	72.7	0.073	55.9	0.286	-37.9
		1500	0.462	158.5	4.02	64.3	0.087	54.8	0.278	-42.2
		1800	0.491	148.3	3.40	56.3	0.100	53.3	0.270	-47.5
		2000	0.515	142.6	3.09	51.4	0.108	51.6	0.267	-51.9
		2200	0.552	136.3	2.86	46.2	0.117	50.3	0.265	-57.1
		2500	0.591	130.0	2.54	39.2	0.128	46.1	0.254	-64.8
		2800	0.630	124.4	2.32	32.1	0.138	44.0	0.264	-73.8
	3000	0.667	121.1	2.13	26.8	0.142	41.8	0.249	-81.3	
	20	100	0.535	-65.9	33.32	142.3	0.016	64.1	0.779	-28.1
		300	0.473	-131.4	17.57	109.1	0.029	54.4	0.440	-42.2
		500	0.451	-156.5	11.31	95.7	0.038	56.1	0.327	-39.4
		800	0.442	-176.7	7.37	83.6	0.052	59.0	0.280	-35.0
		1000	0.444	173.7	5.97	77.3	0.062	59.5	0.272	-34.8
		1200	0.448	166.2	5.04	71.7	0.072	59.0	0.266	-36.3
		1500	0.467	155.2	4.09	63.4	0.087	57.3	0.260	-40.9
		1800	0.496	146.1	3.45	55.7	0.101	55.2	0.254	-46.6
		2000	0.519	140.5	3.14	50.8	0.109	53.6	0.251	-51.2
		2200	0.558	134.5	2.91	45.7	0.118	51.9	0.249	-56.6
		2500	0.596	128.6	2.59	38.9	0.130	47.4	0.239	-64.8
		2800	0.633	123.3	2.35	31.9	0.140	45.4	0.249	-74.0
	3000	0.666	120.3	2.15	26.5	0.144	42.9	0.233	-81.9	
	25	100	0.487	-75.3	35.99	139.4	0.015	64.4	0.746	-30.2
		300	0.466	-139.4	18.03	106.9	0.027	55.7	0.406	-42.4
		500	0.455	-162.0	11.48	94.3	0.036	58.8	0.304	-38.3
		800	0.446	179.8	7.44	82.6	0.051	61.2	0.265	-33.4
		1000	0.452	171.2	6.02	76.4	0.062	61.6	0.260	-33.3
		1200	0.453	163.9	5.08	70.8	0.071	60.7	0.256	-34.8
		1500	0.473	154.0	4.12	62.8	0.086	59.0	0.251	-39.8
		1800	0.503	144.8	3.48	55.2	0.100	56.6	0.245	-45.6
		2000	0.528	139.8	3.16	50.3	0.109	54.5	0.243	-50.3
		2200	0.567	133.8	2.91	45.2	0.118	53.0	0.242	-56.0
2500		0.600	128.2	2.60	38.3	0.130	48.4	0.231	-64.4	
2800		0.640	122.8	2.35	31.5	0.140	46.2	0.241	-74.1	
3000	0.673	119.4	2.16	26.3	0.144	43.7	0.227	-82.0		



BFP67/BFP67R/BFP67W

Vishay Semiconductors

V _{CE} /V	I _C /mA	f/MHz	S11		S21		S12		S22		
			LIN MAG	ANG	LIN MAG	ANG	LIN MAG	ANG	LIN MAG	ANG	
				deg		deg		deg		deg	
5	30	100	0.456	-83.5	37.80	137.1	0.014	62.9	0.718	-31.8	
		300	0.463	-144.8	18.20	105.3	0.025	57.6	0.383	-42.1	
		500	0.459	-165.7	11.51	93.1	0.035	60.9	0.290	-37.0	
		800	0.451	177.4	7.43	81.7	0.051	63.0	0.258	-31.7	
		1000	0.456	169.1	6.00	75.8	0.061	63.0	0.255	-31.8	
		1200	0.461	162.1	5.05	70.1	0.071	62.1	0.252	-33.6	
		1500	0.480	152.6	4.11	62.2	0.086	59.9	0.248	-38.8	
		1800	0.510	144.2	3.45	54.5	0.100	57.6	0.242	-44.7	
		2000	0.535	138.3	3.13	49.9	0.109	55.4	0.240	-49.7	
		2200	0.574	133.1	2.91	44.7	0.118	53.7	0.239	-55.4	
		2500	0.610	127.5	2.58	37.8	0.130	49.1	0.228	-63.9	
		2800	0.651	122.3	2.33	31.0	0.140	47.0	0.240	-73.5	
3000	0.683	119.0	2.14	25.9	0.144	44.4	0.224	-81.6			
8	2	100	0.932	-17.9	6.53	165.5	0.022	77.5	0.972	-7.6	
		300	0.834	-50.6	5.73	141.8	0.058	59.5	0.884	-19.0	
		500	0.729	-76.9	4.80	123.8	0.079	46.9	0.783	-26.1	
		800	0.619	-107.7	3.76	104.3	0.095	35.6	0.684	-31.9	
		1000	0.572	-124.7	3.24	94.3	0.101	30.6	0.642	-35.1	
		1200	0.550	-139.6	2.85	85.5	0.105	27.2	0.613	-37.7	
		1500	0.536	-160.4	2.42	73.6	0.107	23.2	0.584	-42.2	
		1800	0.536	-177.9	2.10	62.8	0.107	21.5	0.562	-46.6	
		2000	0.560	171.4	1.93	56.5	0.106	21.1	0.554	-50.1	
		2200	0.591	161.5	1.82	49.9	0.105	21.8	0.552	-53.8	
		2500	0.612	150.1	1.63	41.1	0.109	21.8	0.545	-59.6	
		2800	0.663	140.1	1.51	32.9	0.108	22.9	0.561	-66.7	
	3000	0.691	134.9	1.38	26.0	0.107	23.1	0.544	-72.2		
	5	5	100	0.841	-27.7	14.15	159.3	0.020	74.2	0.934	-13.1
			300	0.684	-73.7	10.91	129.9	0.047	53.8	0.740	-28.6
			500	0.567	-105.1	8.16	111.5	0.059	44.6	0.598	-34.1
			800	0.487	-135.8	5.76	94.6	0.070	40.4	0.497	-36.3
			1000	0.464	-151.6	4.78	86.2	0.076	39.7	0.464	-37.5
			1200	0.455	-164.3	4.11	78.9	0.081	39.6	0.443	-39.0
			1500	0.462	179.0	3.39	69.0	0.089	39.1	0.423	-42.7
			1800	0.485	164.3	2.90	60.0	0.097	39.5	0.409	-46.8
			2000	0.507	156.4	2.64	54.4	0.102	39.5	0.403	-50.3
			2200	0.542	148.2	2.46	48.6	0.107	39.5	0.402	-54.1
			2500	0.574	139.6	2.20	41.0	0.117	37.2	0.392	-60.2
2800			0.622	132.4	2.01	33.7	0.123	36.9	0.403	-67.6	
3000	0.654	128.0	1.86	27.4	0.126	35.5	0.386	-73.5			



V _{CE} /V	I _C /mA	f/MHz	S11		S21		S12		S22	
			LIN MAG	ANG	LIN MAG	ANG	LIN MAG	ANG	LIN MAG	ANG
				deg		deg		deg		deg
8	10	100	0.719	-40.7	23.17	152.1	0.018	69.5	0.876	-19.4
		300	0.550	-98.6	15.11	119.1	0.037	51.3	0.592	-36.0
		500	0.472	-130.0	10.31	102.9	0.046	48.5	0.451	-37.7
		800	0.431	-156.9	6.91	88.5	0.058	49.3	0.376	-36.3
		1000	0.424	-170.1	5.66	81.3	0.065	50.3	0.357	-36.6
		1200	0.425	179.4	4.80	74.8	0.074	50.8	0.345	-37.7
		1500	0.440	165.8	3.92	66.1	0.085	50.1	0.333	-41.5
		1800	0.465	154.3	3.32	57.9	0.097	49.3	0.323	-46.1
		2000	0.490	147.6	3.03	52.9	0.105	48.1	0.320	-49.9
		2200	0.528	140.5	2.81	47.5	0.113	47.4	0.317	-54.2
		2500	0.563	133.8	2.50	40.4	0.124	43.7	0.306	-61.1
		2800	0.605	127.7	2.29	33.5	0.133	42.1	0.316	-69.2
	3000	0.640	123.7	2.11	27.8	0.136	40.1	0.298	-75.7	
	15	100	0.635	-51.2	29.24	147.1	0.017	67.1	0.828	-23.7
		300	0.494	-114.4	17.00	113.5	0.032	52.2	0.510	-38.8
		500	0.443	-143.6	11.19	98.8	0.040	52.3	0.384	-38.1
		800	0.419	-166.8	7.38	85.7	0.054	55.0	0.326	-34.8
		1000	0.420	-178.9	5.98	79.2	0.063	55.7	0.313	-34.7
		1200	0.424	172.4	5.08	73.3	0.072	55.9	0.305	-36.0
		1500	0.437	160.6	4.13	64.9	0.085	54.6	0.297	-40.0
		1800	0.465	149.6	3.48	57.1	0.098	53.0	0.289	-45.0
		2000	0.488	143.8	3.18	52.1	0.107	51.4	0.286	-49.3
		2200	0.526	137.8	2.94	47.1	0.115	50.4	0.284	-54.0
		2500	0.561	131.6	2.62	40.0	0.126	46.1	0.272	-61.3
		2800	0.606	126.0	2.38	33.2	0.136	44.2	0.282	-69.9
	3000	0.637	122.6	2.19	27.6	0.140	42.0	0.265	-76.9	
	20	100	0.575	-60.1	33.26	143.4	0.016	65.1	0.788	-26.6
		300	0.464	-124.9	17.96	110.1	0.029	54.1	0.459	-39.9
		500	0.436	-151.9	11.60	96.5	0.038	55.7	0.347	-37.3
		800	0.419	-172.8	7.57	84.2	0.052	58.3	0.300	-33.2
		1000	0.417	176.7	6.14	77.9	0.062	58.9	0.292	-33.1
		1200	0.422	168.4	5.19	72.0	0.071	58.5	0.286	-34.5
		1500	0.442	157.4	4.21	64.1	0.085	57.1	0.279	-38.8
		1800	0.470	147.7	3.56	56.4	0.099	55.1	0.272	-44.1
		2000	0.494	142.2	3.23	51.5	0.107	53.3	0.270	-48.7
		2200	0.532	136.3	3.00	46.6	0.116	51.8	0.268	-53.4
2500		0.568	130.1	2.67	39.6	0.127	47.4	0.257	-61.1	
2800		0.608	124.6	2.42	33.1	0.137	45.3	0.266	-70.1	
3000	0.645	121.6	2.23	27.7	0.141	42.8	0.249	-77.3		



BFP67/BFP67R/BFP67W

Vishay Semiconductors

V _{CE} /V	I _C /mA	f/MHz	S11		S21		S12		S22	
			LIN MAG	ANG	LIN MAG	ANG	LIN MAG	ANG	LIN MAG	ANG
				deg		deg		deg		deg
8	25	100	0.532	-67.6	36.13	140.5	0.014	65.4	0.756	-28.4
		300	0.453	-132.6	18.45	107.8	0.027	55.3	0.425	-40.1
		500	0.432	-157.4	11.78	94.9	0.036	58.4	0.324	-36.1
		800	0.419	-176.9	7.65	83.0	0.051	60.5	0.286	-31.5
		1000	0.419	173.7	6.18	77.0	0.061	61.0	0.281	-31.5
		1200	0.428	166.0	5.22	71.3	0.071	60.1	0.276	-33.1
		1500	0.445	155.4	4.24	63.4	0.085	58.4	0.271	-37.9
		1800	0.478	146.2	3.57	55.8	0.099	56.3	0.264	-43.3
		2000	0.500	140.9	3.24	51.0	0.108	54.4	0.262	-47.8
		2200	0.537	135.3	3.00	46.0	0.117	52.4	0.261	-52.9
		2500	0.575	129.0	2.68	39.1	0.128	48.3	0.250	-60.7
		2800	0.616	124.3	2.43	32.5	0.138	46.1	0.260	-70.0
3000	0.651	121.1	2.23	27.4	0.142	43.6	0.242	-77.3		

Typical Characteristics ($T_{amb} = 25^{\circ}\text{C}$ unless otherwise specified)

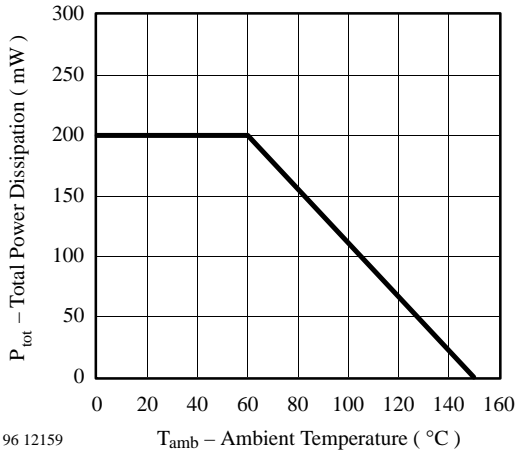

Figure 1. Total Power Dissipation vs. Ambient Temperature

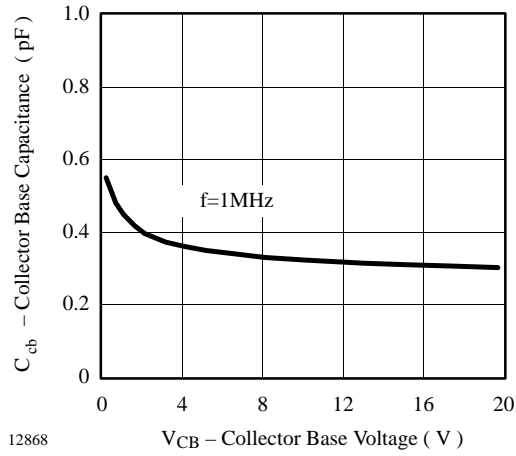

Figure 3. Collector Base Capacitance vs. Collector Base Voltage

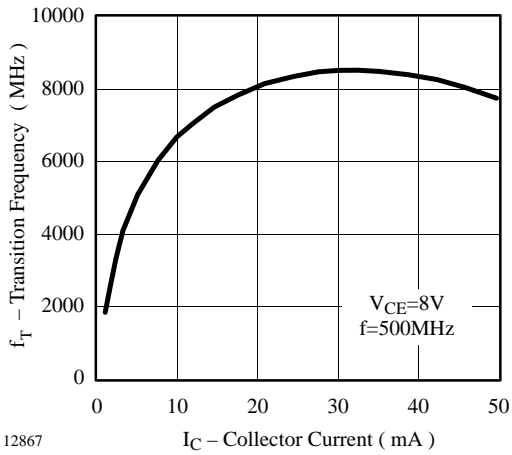

Figure 2. Transition Frequency vs. Collector Current

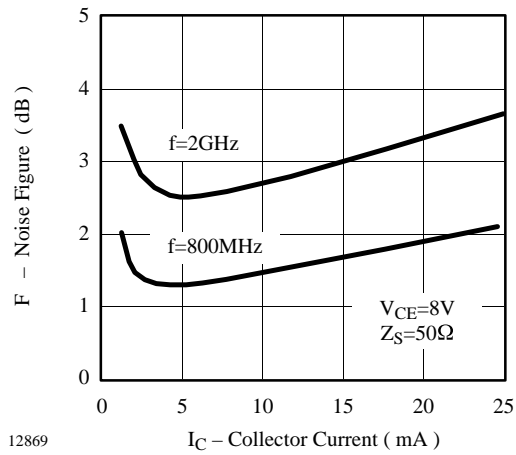

Figure 4. Noise Figure vs. Collector Current



$V_{CE} = 8 \text{ V}$, $I_C = 15 \text{ mA}$, $Z_0 = 50 \Omega$

S_{11}

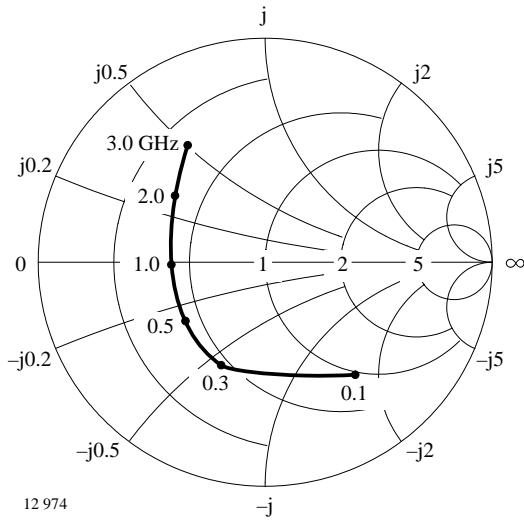

Figure 5. Input reflection coefficient

S_{12}

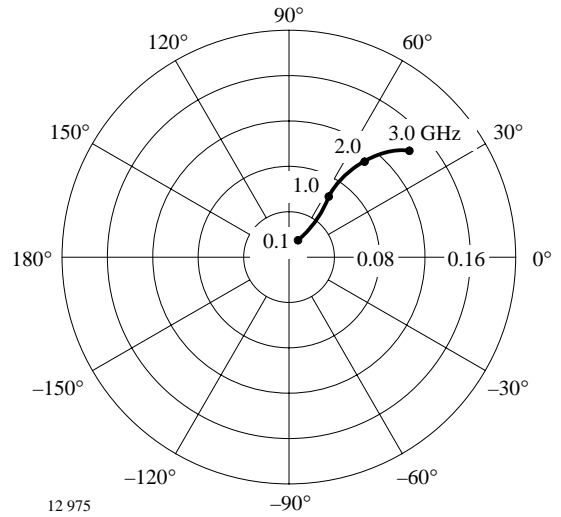

Figure 7. Reverse transmission coefficient

S_{21}

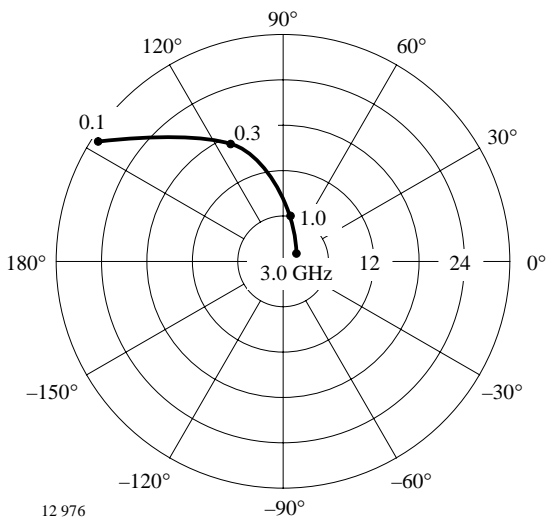

Figure 6. Forward transmission coefficient

S_{22}

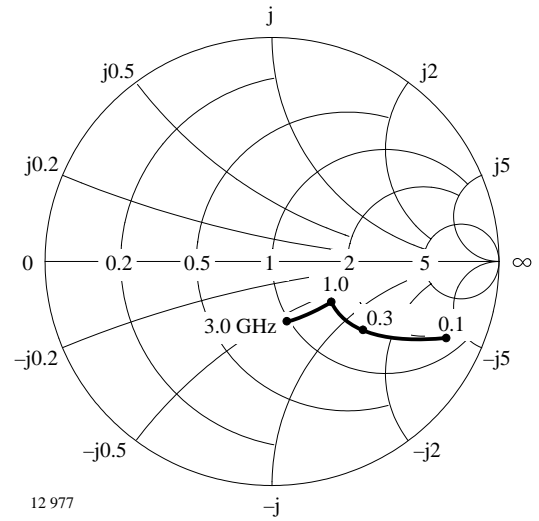
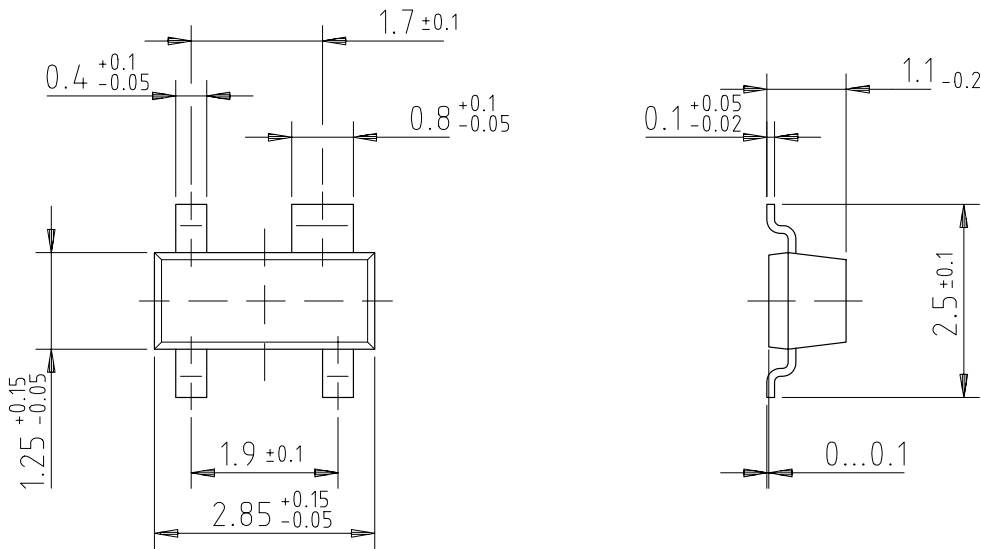
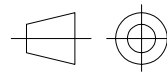

Figure 8. Output reflection coefficient

Dimensions of BFP67 in mm



96 12240



technical drawings
according to DIN
specifications

Dimensions of BFP67R in mm

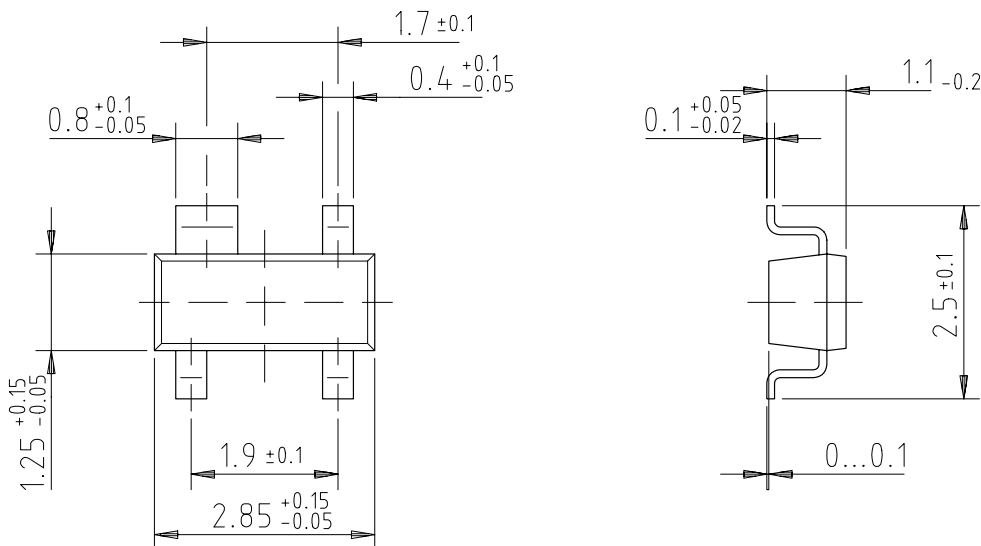

96 12239

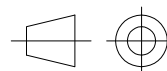

technical drawings
according to DIN
specifications



Dimensions of BFP67W in mm

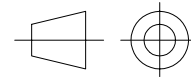
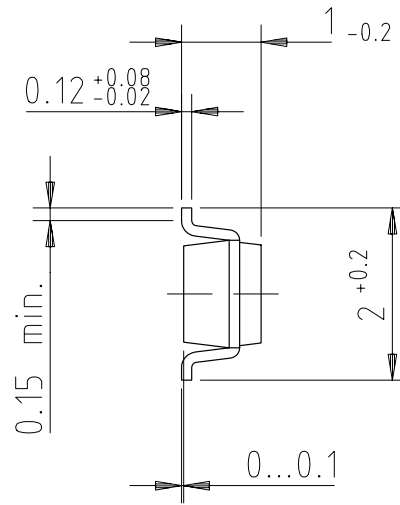
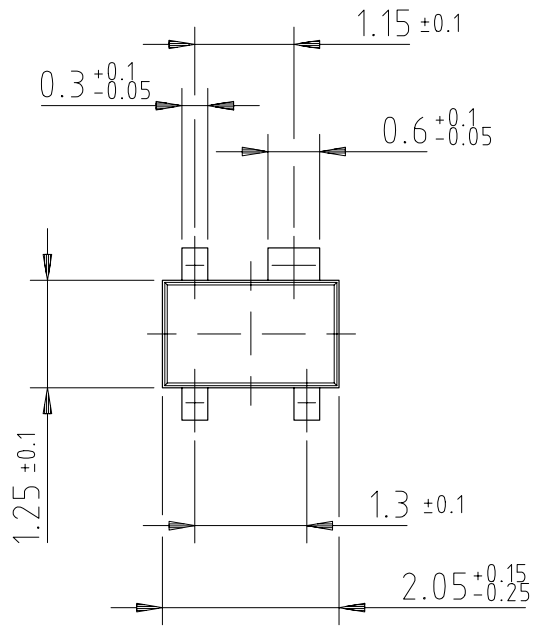

96 12237

technical drawings
according to DIN
specifications

Ozone Depleting Substances Policy Statement

It is the policy of **Vishay Semiconductor GmbH** to

1. Meet all present and future national and international statutory requirements.
2. Regularly and continuously improve the performance of our products, processes, distribution and operating systems with respect to their impact on the health and safety of our employees and the public, as well as their impact on the environment.

It is particular concern to control or eliminate releases of those substances into the atmosphere which are known as ozone depleting substances (ODSs).

The Montreal Protocol (1987) and its London Amendments (1990) intend to severely restrict the use of ODSs and forbid their use within the next ten years. Various national and international initiatives are pressing for an earlier ban on these substances.

Vishay Semiconductor GmbH has been able to use its policy of continuous improvements to eliminate the use of ODSs listed in the following documents.

1. Annex A, B and list of transitional substances of the Montreal Protocol and the London Amendments respectively
2. Class I and II ozone depleting substances in the Clean Air Act Amendments of 1990 by the Environmental Protection Agency (EPA) in the USA
3. Council Decision 88/540/EEC and 91/690/EEC Annex A, B and C (transitional substances) respectively.

Vishay Semiconductor GmbH can certify that our semiconductors are not manufactured with ozone depleting substances and do not contain such substances.

We reserve the right to make changes to improve technical design and may do so without further notice.

Parameters can vary in different applications. All operating parameters must be validated for each customer application by the customer. Should the buyer use Vishay-Semiconductors products for any unintended or unauthorized application, the buyer shall indemnify Vishay-Semiconductors against all claims, costs, damages, and expenses, arising out of, directly or indirectly, any claim of personal damage, injury or death associated with such unintended or unauthorized use.

Vishay Semiconductor GmbH, P.O.B. 3535, D-74025 Heilbronn, Germany
Telephone: 49 (0)7131 67 2831, Fax number: 49 (0)7131 67 2423

This datasheet has been download from:

www.datasheetcatalog.com

Datasheets for electronics components.