

Lead-Mount Triac 1 Ampere/400-600 Volts

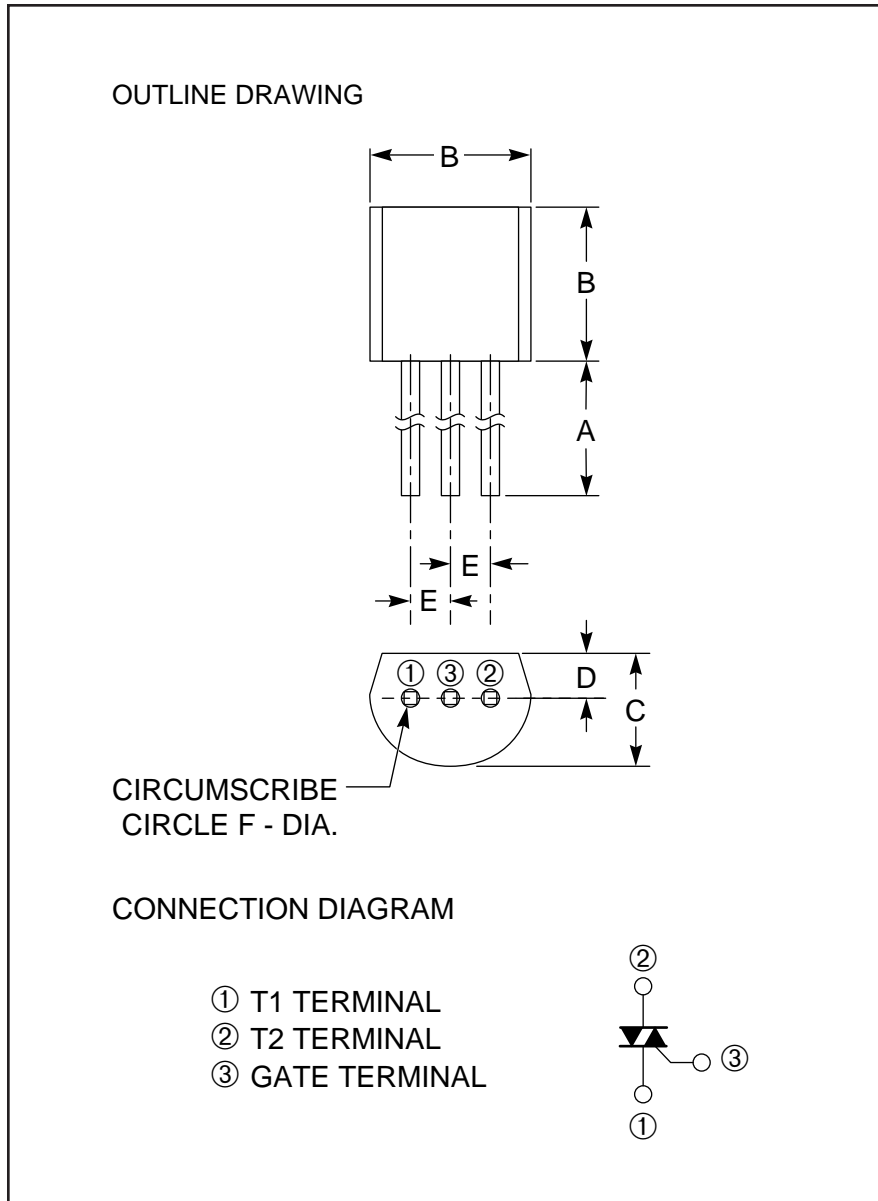

Outline Drawing (Conforms to JEDEC TO-92)

Dimensions	Inches	Millimeters
A	0.45 Min.	12.5 Min.
B	0.20 Max.	5.0 Max.
C	0.15 Max.	3.9 Max.
D	0.05	1.3
E	0.05	1.25
F	0.028 Dia.	0.7 Dia.

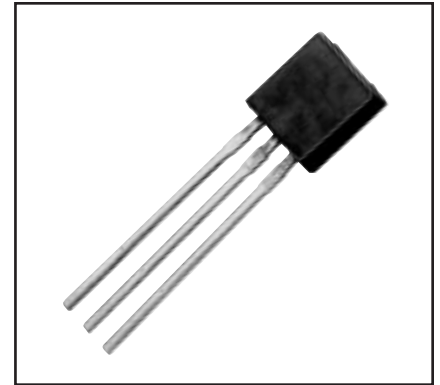

Description:

A triac is a solid state silicon AC switch which may be gate triggered from an off-state to an on-state for either polarity of applied voltage.

Features:

- Glass Passivation

Applications:

- AC Switch

Ordering Information:

Example: Select the complete seven or eight digit part number you desire from the table - i.e. BCR1AM-8 is a 400 Volt, 1 Ampere Triac.

Type	V _{DRM} Volts	Code
BCR1AM	400	-8
	600	-12



Powerex, Inc., 200 Hillis Street, Youngwood, Pennsylvania 15697-1800 (412) 925-7272

BCR1AM

Lead-Mount Triac

1 Ampere/400-600 Volts

Absolute Maximum Ratings, $T_a = 25\text{ }^\circ\text{C}$ unless otherwise specified

Ratings	Symbol	BCR1AM-8	BCR1AM-12	Units
Repetitive Peak Off-state Voltage (Gate Open)	V_{DRM}	400	600	Volts
Non-repetitive Peak Off-state Voltage (Gate Open)	V_{DSM}	500	720	Volts
On-state Current, $T_a = 56^\circ\text{C}$	$I_{T(RMS)}$	1	1	Amperes
Non-repetitive Peak Surge, One Cycle (60 Hz)	I_{TSM}	10	10	Amperes
Non-repetitive Peak Surge, One Cycle (50 Hz)	I_{TSM}	9.1	9.1	Amperes
I^2t for Fusing, $t = 8.3\text{ msec}$	I^2t	0.4	0.4	A^2sec
Peak Gate Power Dissipation, $20\text{ }\mu\text{sec}$	P_{GM}	1	1	Watts
Average Gate Power Dissipation	$P_{G(avg)}$	0.1	0.1	Watts
Peak Gate Current	I_{GM}	1	1	Amperes
Peak Gate Voltage	V_{GM}	6	6	Volts
Storage Temperature	T_{stg}	-40 to 125	-40 to 125	$^\circ\text{C}$
Operating Temperature	T_j	-40 to 125	-40 to 125	$^\circ\text{C}$
Weight	–	0.23	0.23	Grams

Electrical and Thermal Characteristics, $T_j = 25\text{ }^\circ\text{C}$ unless otherwise specified

Characteristics*	Symbol	Test Conditions (Trigger Mode)				BCR1AM			Units
		V_D	R_L	R_G	T_j	Min.	Typ.	Max.	
Gate – Parameters									
DC Gate Trigger Current									
MT2+ Gate+	I_{GT}	6V	6Ω	330Ω	25°C	–	–	5	mA
MT2+ Gate–		6V	6Ω	330Ω	25°C	–	–	5	mA
MT2– Gate–		6V	6Ω	330Ω	25°C	–	–	5	mA
MT2– Gate+		6V	6Ω	330Ω	25°C	–	–	10	mA
DC Gate Trigger Voltage									
MT2+ Gate+	V_{GT}	6V	6Ω	330Ω	25°C	–	–	2	Volts
MT2+ Gate–		6V	6Ω	330Ω	25°C	–	–	2	Volts
MT2– Gate–		6V	6Ω	330Ω	25°C	–	–	2	Volts
MT2– Gate+		6V	6Ω	330Ω	25°C	–	–	2	Volts
DC Gate Non-trigger Voltage									
All	V_{GD}	$1/2 V_{DRM}$	–	–	125°C	0.1	–	–	Volts

*Characteristic values apply for either polarity of Main Terminal 2 referenced to Main Terminal 1.

Characteristics	Symbol	Test Conditions	Min.	Typ.	Max.	Units
Thermal Resistance, Junction-to-case	$R_{th(j-c)}$	–	–	–	50	$^\circ\text{C}/\text{W}$
Steady State Thermal Resistance, Junction-to-ambient	$R_{th(j-a)}$	–	–	–	120	$^\circ\text{C}/\text{W}$
Voltage – Blocking State Repetitive Off-state Current	I_{DRM}	Gate Open Circuited, $V_D = V_{DRM}$, $T_j = 125^\circ\text{C}$	–	–	1	mA
Current – Conducting State Peak On-state Voltage	V_{TM}	$T_c = 25^\circ\text{C}$, 8.3ms Pulsewidth Duty Cycle <2%, $I_{TM} = 1.5\text{A}$	–	–	1.6	Volts
Critical Rate-of-Rise of Commutating Off-state Voltage (Commutating dv/dt) ▲ (Switching)	$(dv/dt)_c$	–	–	–	–	$\text{V}/\mu\text{s}$

BCR1AM

Lead-Mount Triac

1 Ampere/400-600 Volts

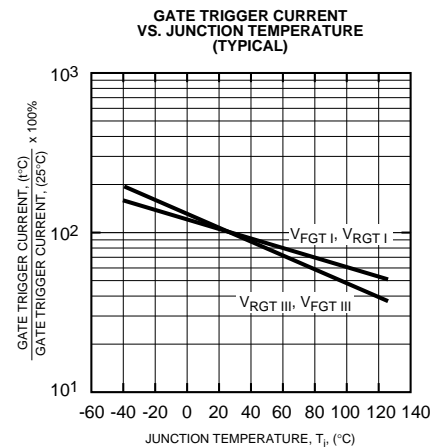
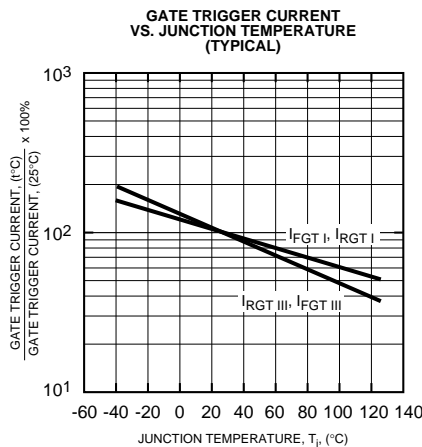
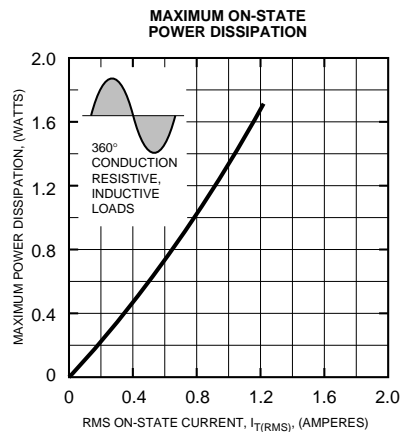
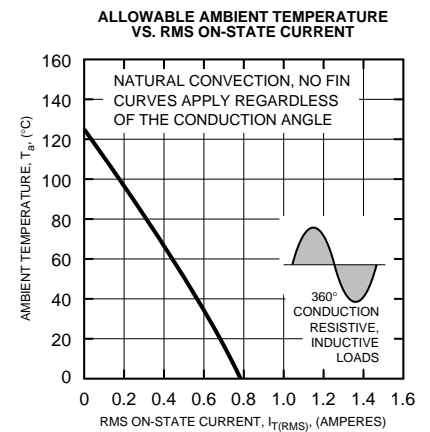
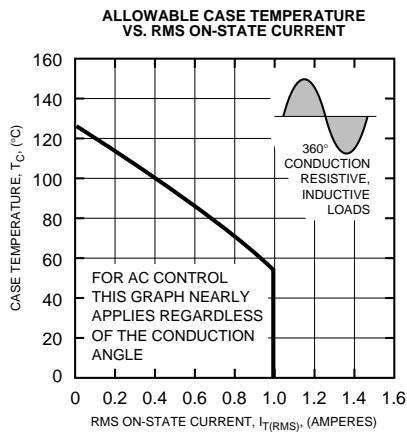
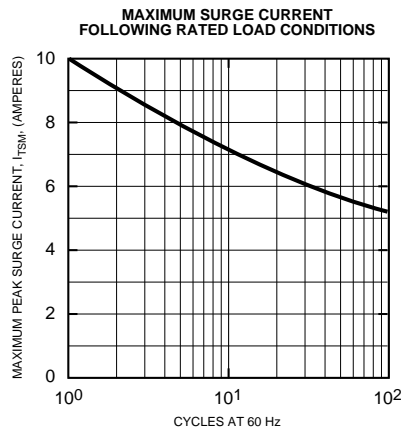
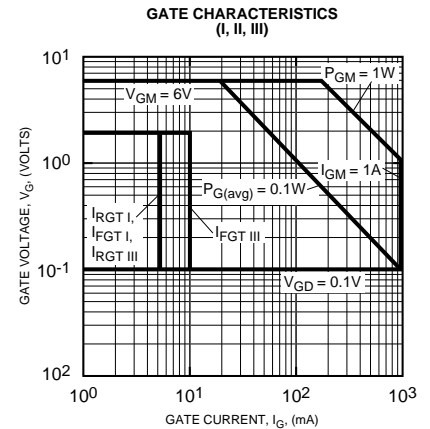
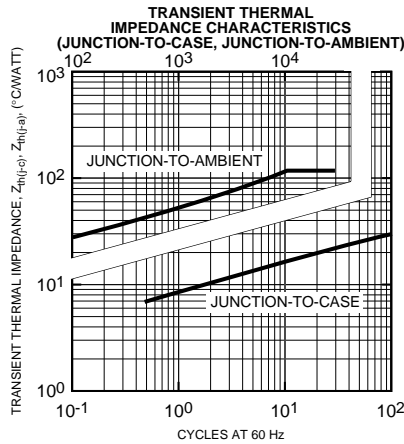
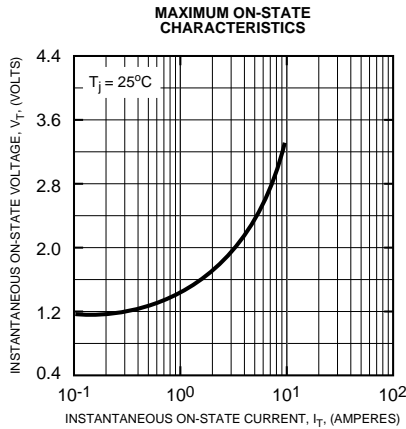

BCR1AM
Lead-Mount Triac
 1 Ampere/400-600 Volts

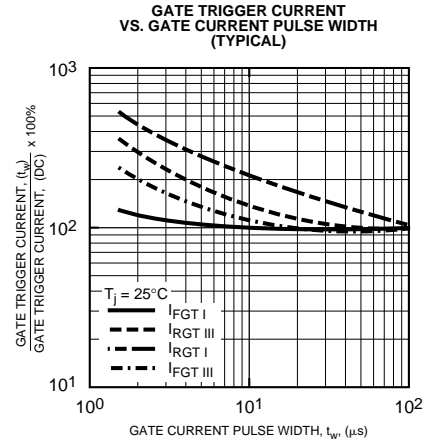
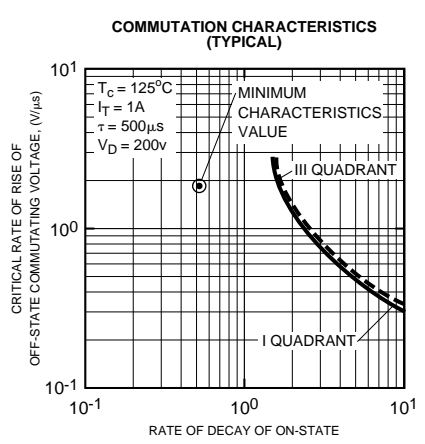
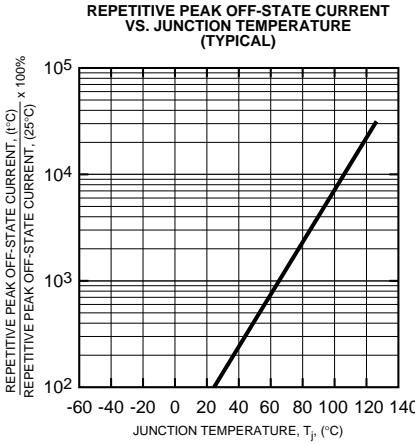
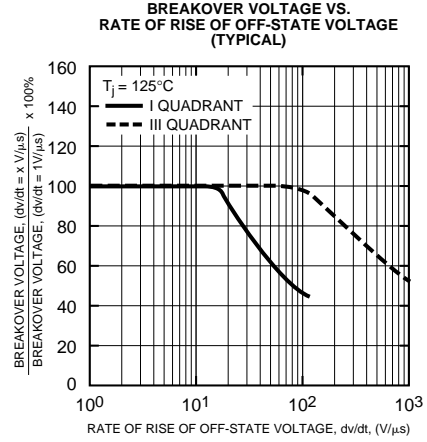
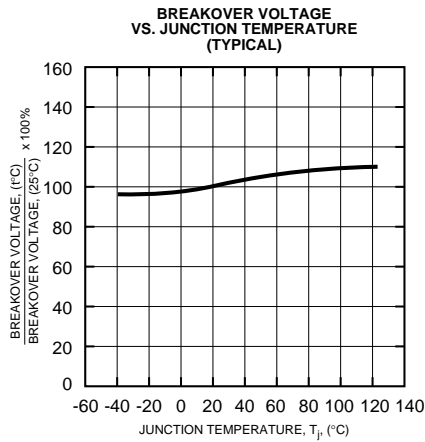
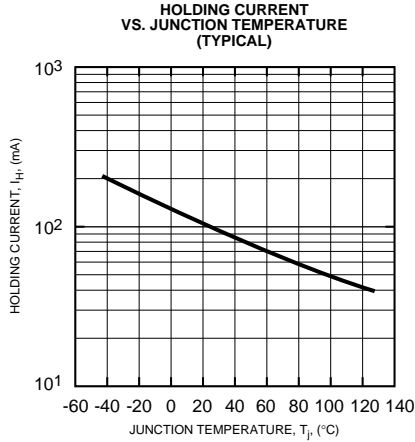

GATE TRIGGER CHARACTERISTICS TEST CIRCUITS

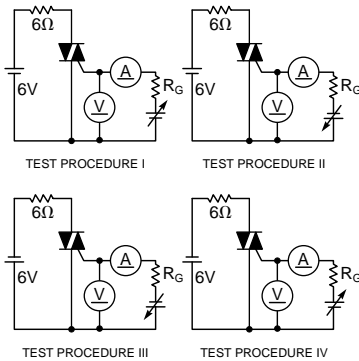

Δ Part Number	V_{DRM} (Volts)	Commutating dv/dt , $(dv/dt)_c$ (V/μsec)		Test Condition	Commutating Voltage & Current Waveform (Inductive Load)
		Minimum	Value		
BCR1AM-8	400	2		$T_j = 125^\circ\text{C}$, Rate of Decay On-state Commutating Current $(di/dt)_c = -0.5\text{A/msec}$, Peak Off-state Voltage $V_D = 400\text{V}$	
BCR1AM-12	600	2			

This datasheet has been download from:

www.datasheetcatalog.com

Datasheets for electronics components.