

General Description

The MDP1901 uses advanced MagnaChip's MOSFET Technology, which provides high performance in on-state resistance, fast switching performance and excellent quality. MDP1901 is suitable device for DC/DC Converters and general purpose applications.

Features

- $V_{DS} = 100V$
- $I_D = 36A$ @ $V_{GS} = 10V$
- $R_{DS(ON)} < 22m\Omega$ @ $V_{GS} = 10V$
 $< 25m\Omega$ @ $V_{GS} = 6.0V$

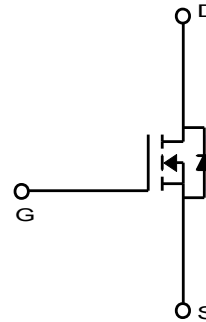
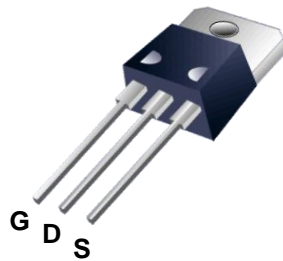

Absolute Maximum Ratings (Tc = 25°C)

Characteristics	Symbol	Rating	Unit
Drain-Source Voltage	V_{DSS}	100	V
Gate-Source Voltage	V_{GSS}	±20	V
Continuous Drain Current	I_D	$T_C=25^\circ C$	36
		$T_C=100^\circ C$	24
Pulsed Drain Current	I_{DM}	144	A
Power Dissipation	P_D	$T_C=25^\circ C$	34
		$T_C=100^\circ C$	14
Single Pulse Avalanche Energy ⁽²⁾	E_{AS}	200	mJ
Junction and Storage Temperature Range	T_J, T_{stg}	-55~150	°C

Thermal Characteristics

Characteristics	Symbol	Rating	Unit
Thermal Resistance, Junction-to-Ambient	$R_{\theta JA}$	40	°C/W
Thermal Resistance, Junction-to-Case	$R_{\theta JC}$	2.3	

Ordering Information

Part Number	Temp. Range	Package	Packing	Rohs Status
MDP1901TH	-55~150°C	TO-220	Tube	Halogen Free

Electrical Characteristics (Tc =25°C)

Characteristics	Symbol	Test Condition	Min	Typ	Max	Unit
Static Characteristics						
Drain-Source Breakdown Voltage	BV_{DSS}	$I_D = 250\mu A, V_{GS} = 0V$	100	-	-	V
Gate Threshold Voltage	$V_{GS(th)}$	$V_{DS} = V_{GS}, I_D = 250\mu A$	2.0	2.8	4.0	
Drain Cut-Off Current	I_{DSS}	$V_{DS} = 80V, V_{GS} = 0V$	-	-	1	μA
Gate Leakage Current	I_{GSS}	$V_{GS} = \pm 20V, V_{DS} = 0V$	-	-	± 0.1	
Drain-Source ON Resistance	$R_{DS(on)}$	$V_{GS} = 10V, I_D = 35A$	-	17	22	m Ω
		$T_J = 125^\circ C$	-	28	33	
		$V_{GS} = 6.0V, I_D = 20A$		19	25	
Forward Transconductance	g_{fs}	$V_{DS} = 5V, I_D = 35A$	-	35	-	S
Dynamic Characteristics						
Total Gate Charge	Q_g	$V_{DS} = 50V, I_D = 20A, V_{GS} = 10V$	-	75	110	nC
Gate-Source Charge	Q_{gs}		-	20	-	
Gate-Drain Charge	Q_{gd}		-	18	-	
Input Capacitance	C_{iss}	$V_{DS} = 30V, V_{GS} = 0V, f = 1.0MHz$	-	3045	-	pF
Reverse Transfer Capacitance	C_{rss}		-	160	-	
Output Capacitance	C_{oss}		-	234	-	
Gate Resistance	R_g	$V_{GS} = 0V, V_{DS} = 0V, F = 1MHz$	-	0.81	-	Ω
Turn-On Delay Time	$t_{d(on)}$	$V_{GS} = 10V, V_{DS} = 50V, R_L = 30\Omega, R_G = 6\Omega$	-	25	40	ns
Rise Time	t_r		-	12	20	
Turn-Off Delay Time	$t_{d(off)}$		-	70	120	
Fall Time	t_f		-	20	35	
Drain-Source Body Diode Characteristics						
Source-Drain Diode Forward Voltage	V_{SD}	$I_S = 1A, V_{GS} = 0V$	-	0.7	1.2	V
Body Diode Reverse Recovery Time	t_{rr}	$I_F = 20A, di/dt = 100A/\mu s$	-	70	100	ns
Body Diode Reverse Recovery Charge	Q_{rr}		-	240	-	nC

Note :

- Surface mounted RF4 board with 2oz. Copper.
- Starting $T_J = 25^\circ C, L = 1mH, I_{AS} = 20A, V_{DD} = 50V, V_{GS} = 10V$

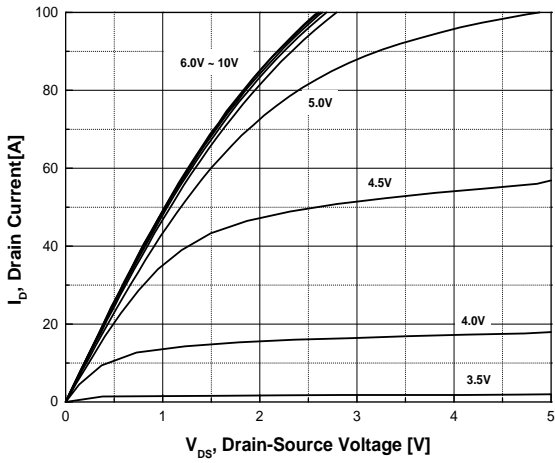

Fig.1 On-Region Characteristics

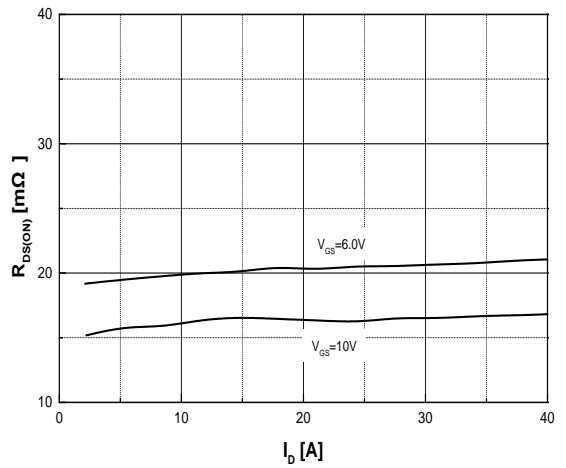

Fig.2 On-Resistance Variation with Drain Current and Gate Voltage

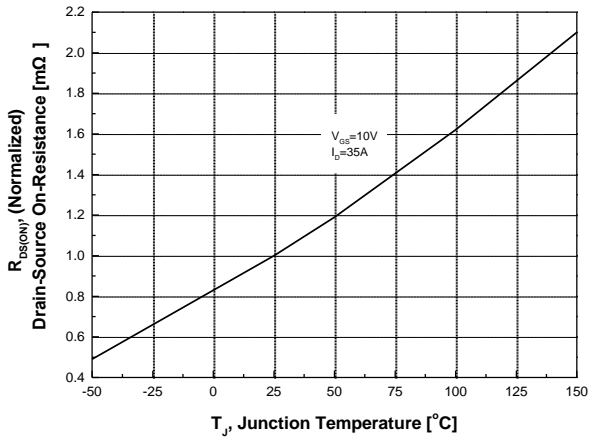

Fig.3 On-Resistance Variation with Temperature

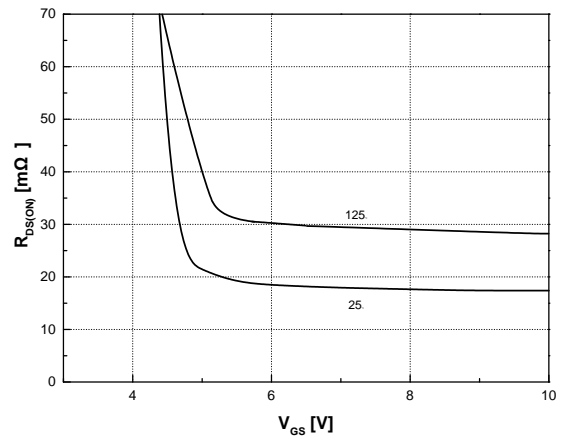

Fig.4 On-Resistance Variation with Gate to Source Voltage

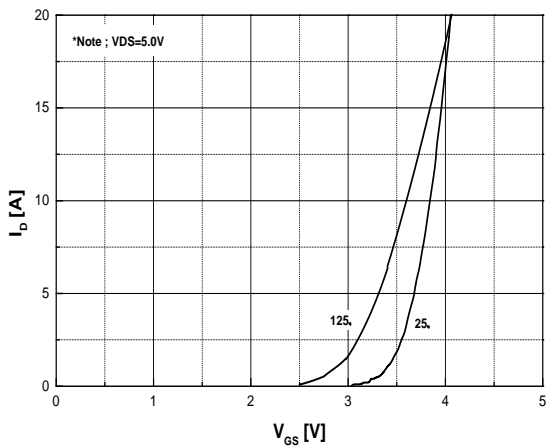

Fig.5 Transfer Characteristics

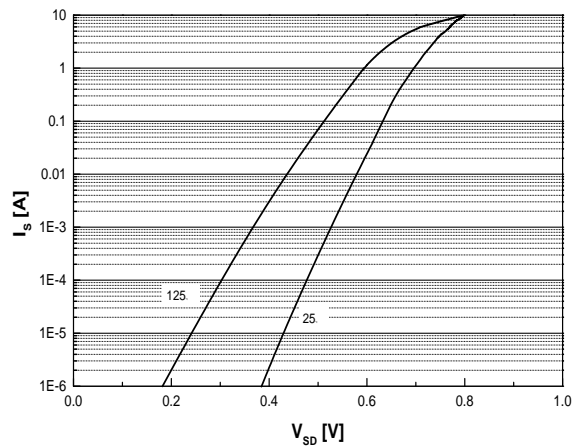

Fig.6 Body Diode Forward Voltage Variation with Source Current and Temperature

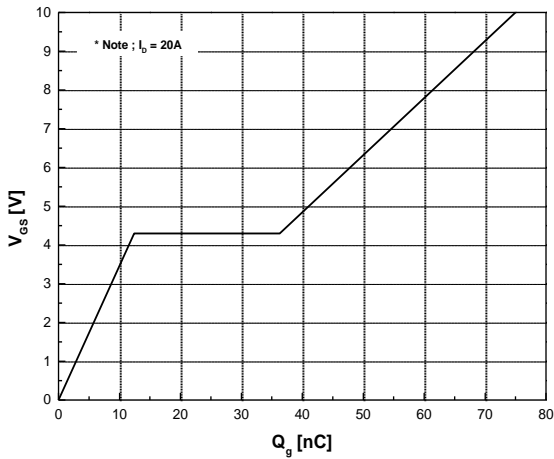

Fig.7 Gate Charge Characteristics

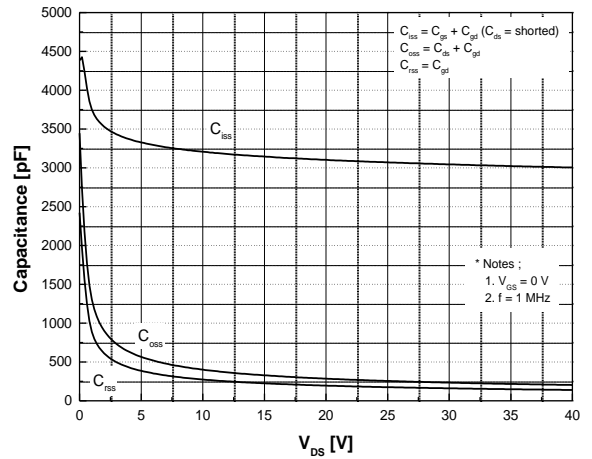

Fig.8 Capacitance Characteristics

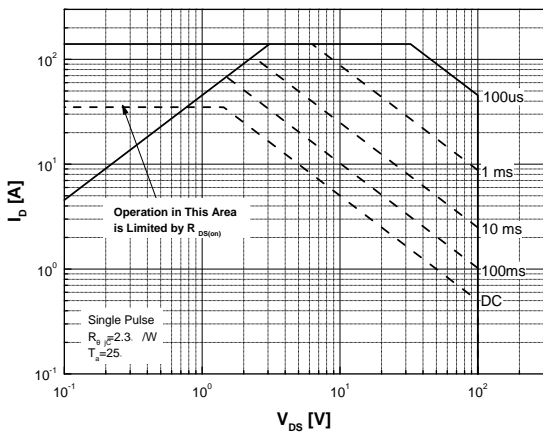

Fig.9 Maximum Safe Operating Area

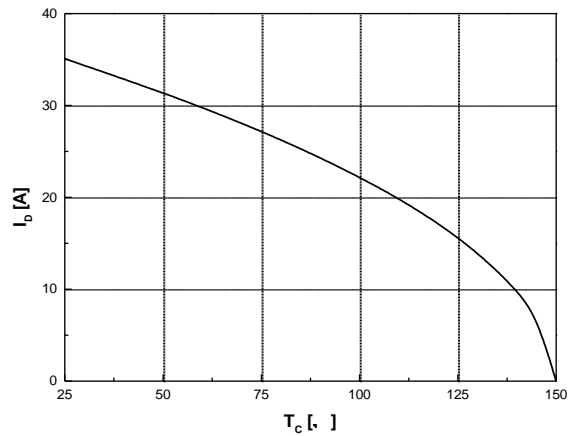

Fig.10 Maximum Drain Current vs. Case Temperature

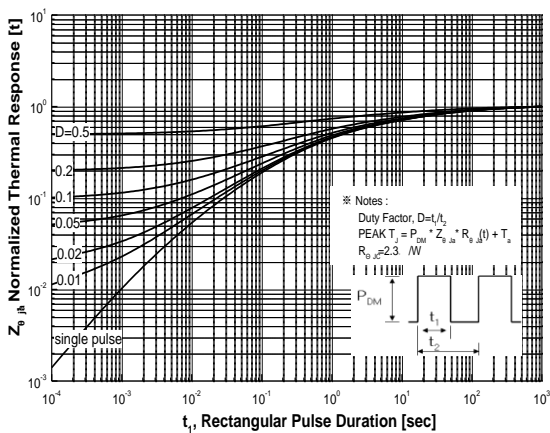
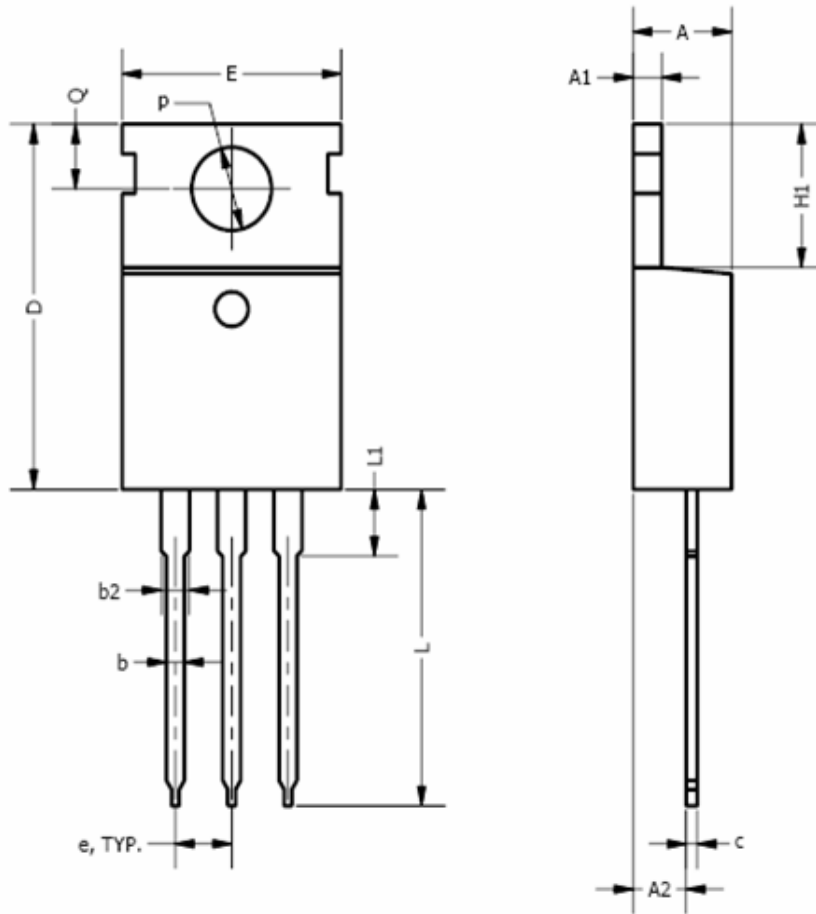

Fig.11 Transient Thermal Response Curve

Physical Dimensions

3 Leads, TO-220

Dimensions are in millimeters unless otherwise specified



Symbol	Min	Nom	Max
A	3.56		4.83
A1	0.50		1.40
A2	2.03		2.92
b	0.38	0.69	1.02
b2	1.14	1.45	1.78
c	0.36		0.61
D	14.22		16.51
e	2.54 TYP		
E	9.65		10.67
H1	5.84		6.86
L	12.70		14.73
L1			6.35
ϕP	3.53		4.09
Q	2.54		3.43

DISCLAIMER:

The Products are not designed for use in hostile environments, including, without limitation, aircraft, nuclear power generation, medical appliances, and devices or systems in which malfunction of any Product can reasonably be expected to result in a personal injury. Seller's customers using or selling Seller's products for use in such applications do so at their own risk and agree to fully defend and indemnify Seller.

MagnaChip reserves the right to change the specifications and circuitry without notice at any time. MagnaChip does not consider responsibility for use of any circuitry other than circuitry entirely included in a MagnaChip product. [MagnaChip](#) is a registered trademark of MagnaChip Semiconductor Ltd.