

Turbo 2 ultrafast high voltage rectifier

Features

- Ultrafast recovery
- Low reverse recovery current
- Reduces losses in diode and switching transistor
- Low thermal resistance
- Higher frequency operation
- Insulated TO-220FPAC version
 - Insulation voltage = 1500 V rms
 - Package capacitance = 12 pF

Description

ST's **STTH8S06** is a state of the art ultrafast recovery diode. By the use of **600 V Pt doping planar technology**, this diode will out-perform the power factor corrections circuits operating in hardswitching conditions. The extremely low reverse recovery current of the **STTH8S06**, reduces significantly the switching power losses of the MOSFET and thus increases the efficiency of the application. This leads designers to reduce the size of their heatsinks.

This device is also intended for applications in power supplies and power conversions systems, motor drive, and other power switching applications.

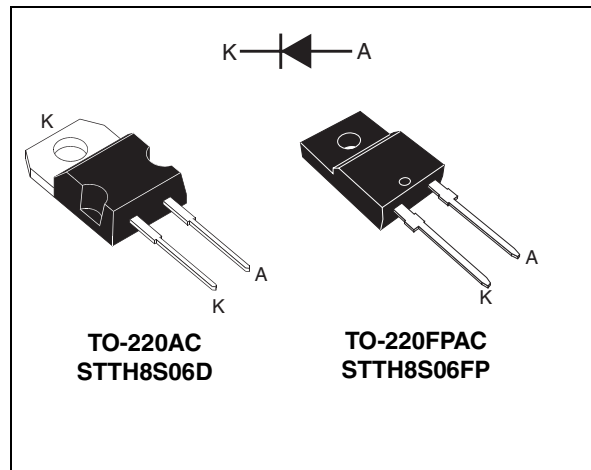

Table 1. Device summary

$I_{F(AV)}$	8 A
V_{RRM}	600 V
$I_{RM}(typ.)$	4.4 A
$T_j(max)$	175 °C
$V_F(typ)$	1.5 V
$t_{rr}(typ)$	12 ns

1 Characteristics

Table 2. Absolute ratings (limiting values)

Symbol	Parameter	Value	Unit
V_{RRM}	Repetitive peak reverse voltage	600	V
$I_{F(AV)}$	Average forward current	8	A
I_{FSM}	Surge non repetitive forward current	$t_p = 10 \text{ ms}$	A
T_{stg}	Storage temperature range	-65 to + 175	°C
T_j	Maximum operating junction temperature	175	°C

Table 3. Thermal parameter

Symbol	Parameter	Maximum	Unit
$R_{th(j-c)}$	Junction to case	TO-220AC	3.0
		TO220FPAC	5.5

Table 4. Static electrical characteristics

Symbol	Parameter	Test conditions	Min.	Typ	Max.	Unit
I_R	Reverse leakage current	$T_j = 25 \text{ °C}$	$V_R = 600 \text{ V}$		20	μA
		$T_j = 125 \text{ °C}$		25	200	
V_F	Forward voltage drop	$T_j = 25 \text{ °C}$	$I_F = 8 \text{ A}$		3.4	V
		$T_j = 125 \text{ °C}$		1.5	1.9	

To evaluate the maximum conduction losses use the following equation:
 $P = 1.20 \times I_{F(AV)} + 0.087 I_{F(RMS)}^2$

Table 5. Dynamic electrical characteristics

Symbol	Parameter	Test conditions	Min.	Typ	Max.	Unit
t_{rr}	Reverse recovery time	$I_F = 1 \text{ A}, di_F/dt = - 200 \text{ A}/\mu\text{s}, V_R = 30 \text{ V}$		12	18	ns
I_{RM}	Reverse current	$T_j = 25 \text{ °C}$ $I_F = 8 \text{ A}, di_F/dt = - 200 \text{ A}/\mu\text{s}, V_R = 200 \text{ V}$		1.6	2.2	A
S_{factor}	Softness factor			1		-
Q_{rr}	Reverse recovery charges			17		nC
I_{RM}	Reverse current	$T_j = 125 \text{ °C}$ $I_F = 8 \text{ A}, di_F/dt = - 200 \text{ A}/\mu\text{s}, V_R = 200 \text{ V}$		4.4	6.0	A
S_{factor}	Softness factor			0.3		-
Q_{rr}	Reverse recovery charges			90		nC

Figure 1. Forward voltage drop versus forward current

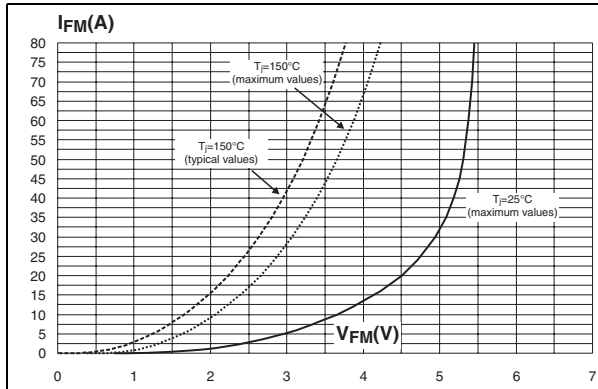

Figure 2. Relative variation of thermal impedance junction to case versus pulse duration (TO-220AC)

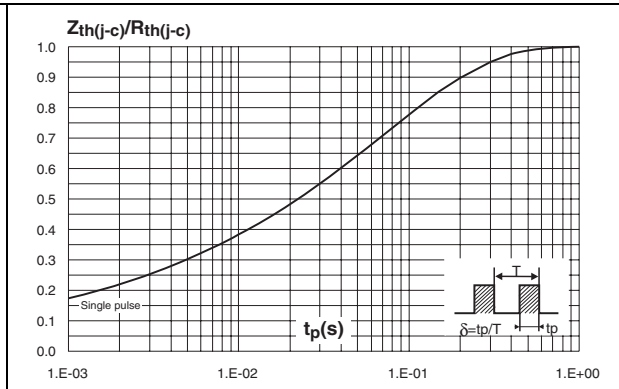

Figure 3. Relative variation of thermal impedance junction to case versus pulse duration (TO-220FPAC)

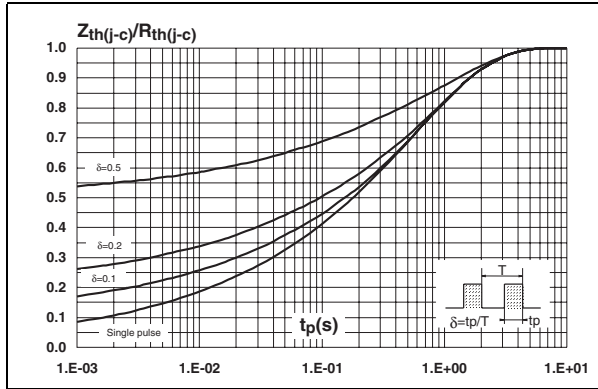

Figure 4. Peak reverse recovery current versus diF/dt (typical values)

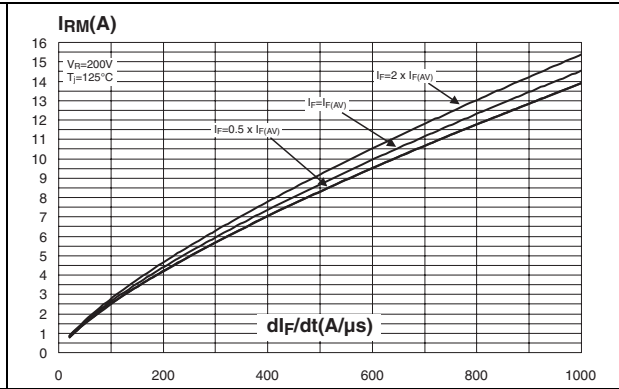

Figure 5. Reverse recovery time versus di_F/dt (typical values) **Figure 6. Reverse recovery charges versus di_F/dt (typical values)**

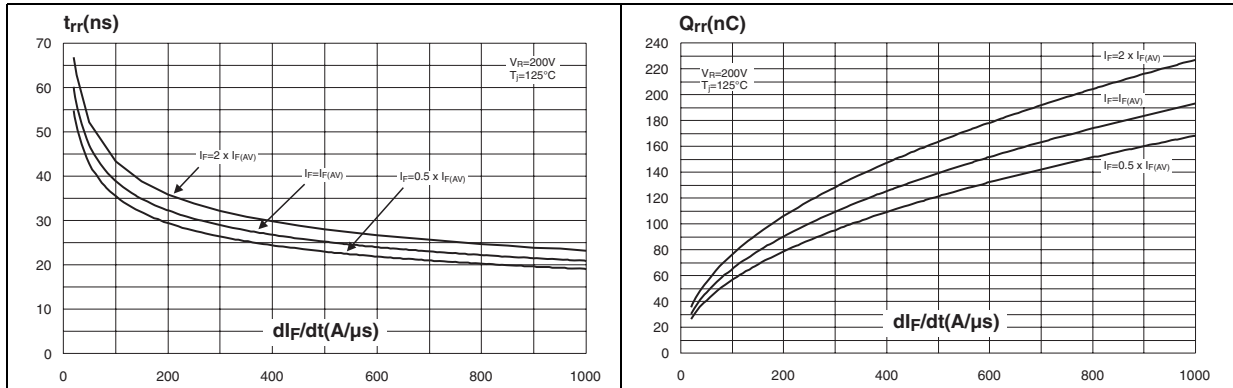
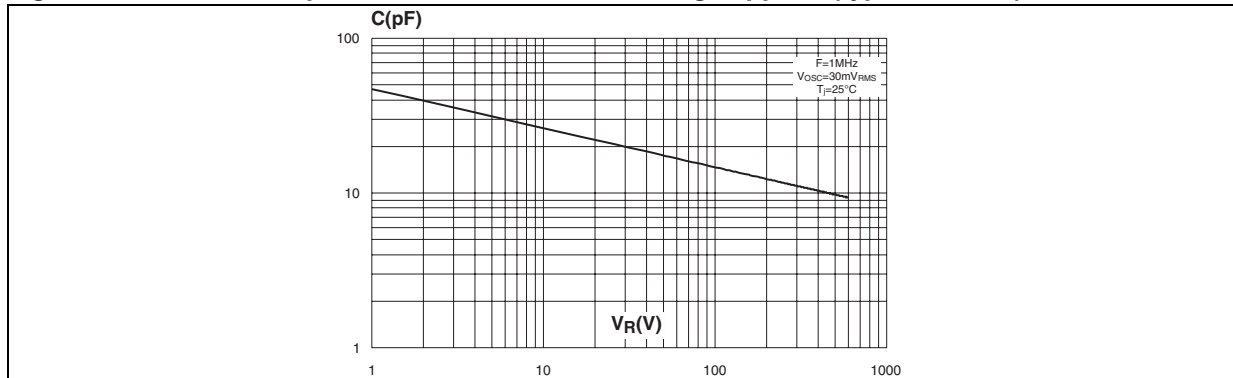

Figure 7. Junction capacitance versus reverse voltage applied (typical values)



2 Package information

- Epoxy meets UL94, V0
- Cooling method: by conduction (C)
- Recommended torque value: 0.4 to 0.6 N·m

In order to meet environmental requirements, ST (also) offers these devices in ECOPACK® packages. ECOPACK® packages are Lead-free. The category of second level Interconnect is marked on the package and on the inner box label, in compliance with JEDEC Standard JESD97. The maximum ratings related to soldering conditions are also marked on the inner box label.

ECOPACK is an ST trademark. ECOPACK specifications are available at: www.st.com.

Table 6. TO-220AC dimensions

Ref.	Dimensions			
	Millimeters		Inches	
	Min.	Max.	Min.	Max.
A	4.40	4.60	0.173	0.181
C	1.23	1.32	0.048	0.051
D	2.40	2.72	0.094	0.107
E	0.49	0.70	0.019	0.027
F	0.61	0.88	0.024	0.034
F1	1.14	1.70	0.044	0.066
G	4.95	5.15	0.194	0.202
H2	10.00	10.40	0.393	0.409
L2	16.40 typ.		0.645 typ.	
L4	13.00	14.00	0.511	0.551
L5	2.65	2.95	0.104	0.116
L6	15.25	15.75	0.600	0.620
L7	6.20	6.60	0.244	0.259
L9	3.50	3.93	0.137	0.154
M	2.6 typ.		0.102 typ.	
Diam. I	3.75	3.85	0.147	0.151

Table 7. TO-220FPAC dimensions

Ref.	Dimensions			
	Millimeters		Inches	
	Min.	Max.	Min.	Max.
A	4.4	4.6	0.173	0.181
B	2.5	2.7	0.098	0.106
D	2.5	2.75	0.098	0.108
E	0.45	0.70	0.018	0.027
F	0.75	1	0.030	0.039
F1	1.15	1.70	0.045	0.067
G	4.95	5.20	0.195	0.205
G1	2.4	2.7	0.094	0.106
H	10	10.4	0.393	0.409
L2	16 Typ.		0.63 Typ.	
L3	28.6	30.6	1.126	1.205
L4	9.8	10.6	0.386	0.417
L5	2.9	3.6	0.114	0.142
L6	15.9	16.4	0.626	0.646
L7	9.00	9.30	0.354	0.366
Dia.	3.00	3.20	0.118	0.126

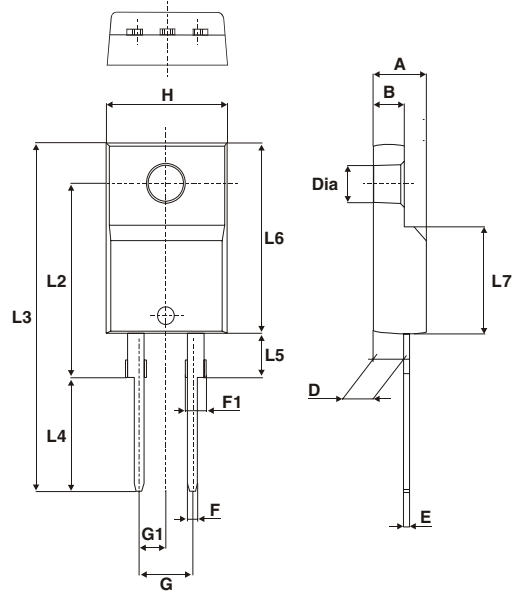

3 Ordering information

Table 8. Ordering information

Order code	Marking	Package	Weight	Base qty	Delivery mode
STTH8S06D	STTH8S06D	TO-220AC	1.9 g	50	Tube
STTH8S06FP	STTH8S06FP	TO-220FPAC	1.64 g	50	Tube

4 Revision history

Table 9. Document revision history

Date	Revision	Description of changes
18-Dec-2007	1	First issue.

Please Read Carefully:

Information in this document is provided solely in connection with ST products. STMicroelectronics NV and its subsidiaries ("ST") reserve the right to make changes, corrections, modifications or improvements, to this document, and the products and services described herein at any time, without notice.

All ST products are sold pursuant to ST's terms and conditions of sale.

Purchasers are solely responsible for the choice, selection and use of the ST products and services described herein, and ST assumes no liability whatsoever relating to the choice, selection or use of the ST products and services described herein.

No license, express or implied, by estoppel or otherwise, to any intellectual property rights is granted under this document. If any part of this document refers to any third party products or services it shall not be deemed a license grant by ST for the use of such third party products or services, or any intellectual property contained therein or considered as a warranty covering the use in any manner whatsoever of such third party products or services or any intellectual property contained therein.

UNLESS OTHERWISE SET FORTH IN ST'S TERMS AND CONDITIONS OF SALE ST DISCLAIMS ANY EXPRESS OR IMPLIED WARRANTY WITH RESPECT TO THE USE AND/OR SALE OF ST PRODUCTS INCLUDING WITHOUT LIMITATION IMPLIED WARRANTIES OF MERCHANTABILITY, FITNESS FOR A PARTICULAR PURPOSE (AND THEIR EQUIVALENTS UNDER THE LAWS OF ANY JURISDICTION), OR INFRINGEMENT OF ANY PATENT, COPYRIGHT OR OTHER INTELLECTUAL PROPERTY RIGHT.

UNLESS EXPRESSLY APPROVED IN WRITING BY AN AUTHORIZED ST REPRESENTATIVE, ST PRODUCTS ARE NOT RECOMMENDED, AUTHORIZED OR WARRANTED FOR USE IN MILITARY, AIR CRAFT, SPACE, LIFE SAVING, OR LIFE SUSTAINING APPLICATIONS, NOR IN PRODUCTS OR SYSTEMS WHERE FAILURE OR MALFUNCTION MAY RESULT IN PERSONAL INJURY, DEATH, OR SEVERE PROPERTY OR ENVIRONMENTAL DAMAGE. ST PRODUCTS WHICH ARE NOT SPECIFIED AS "AUTOMOTIVE GRADE" MAY ONLY BE USED IN AUTOMOTIVE APPLICATIONS AT USER'S OWN RISK.

Resale of ST products with provisions different from the statements and/or technical features set forth in this document shall immediately void any warranty granted by ST for the ST product or service described herein and shall not create or extend in any manner whatsoever, any liability of ST.

ST and the ST logo are trademarks or registered trademarks of ST in various countries.

Information in this document supersedes and replaces all information previously supplied.

The ST logo is a registered trademark of STMicroelectronics. All other names are the property of their respective owners.

© 2007 STMicroelectronics - All rights reserved

STMicroelectronics group of companies

Australia - Belgium - Brazil - Canada - China - Czech Republic - Finland - France - Germany - Hong Kong - India - Israel - Italy - Japan - Malaysia - Malta - Morocco - Singapore - Spain - Sweden - Switzerland - United Kingdom - United States of America

www.st.com